

midi LOGGER GL840

Quick Start Guide

604849022 GL840-UM-852



GRAPHTEC

Instrumentation
Devices 

Instrumentation Devices Srl
Via Acquanera 29 - 22100 COMO (Italy)
ph +39 031 525 391- fax +39 031 507 984
info@instrumentation.it - www.instrumentation.it

Thank you for choosing Graphtec midi LOGGER GL840.
The Quick Start Guide is to assist you with basic operations.
Please refer to the USER' S MANUAL (PDF) in the CD-ROM for more
in-depth information.

Check the exterior of the unit to ensure that there are no cracks, defects, or
any other damages before use.

Accessories

- Quick Start Guide : 1
- Ferrite core: 1
- CD-ROM : 1
- AC cable/AC adapter : 1

Contents

Nomenclature	2
Connection Procedures	3
Safety Guide for using GL840	5
Descriptions of the Control Panel Keys	7
Descriptions of the Menu Screens	10
Measurement Procedure	11
1. Preparations : Hardware set up for recording	11
2. Setup : Menu Operation	12
3. Data record : How to Record	15
4. Data Replay : How to Replay Recorded Data	16
Additional Features	17
Trigger Functions to Control Recording Start/Stop Operations	17
Span, Trace and Position Functions to Adjust the Waveform Display	19
Specifications	20
Standard Specifications	20
External Input/Output Functions	20
Common specification of the terminal in the input section	21
Specification of input section (GL840-M with standard terminal)	21
Specification of input section (GL840-WV Withstand High Voltage high-precision terminal) ...	22
Installation Guide	22

Nomenclature

Top Panel

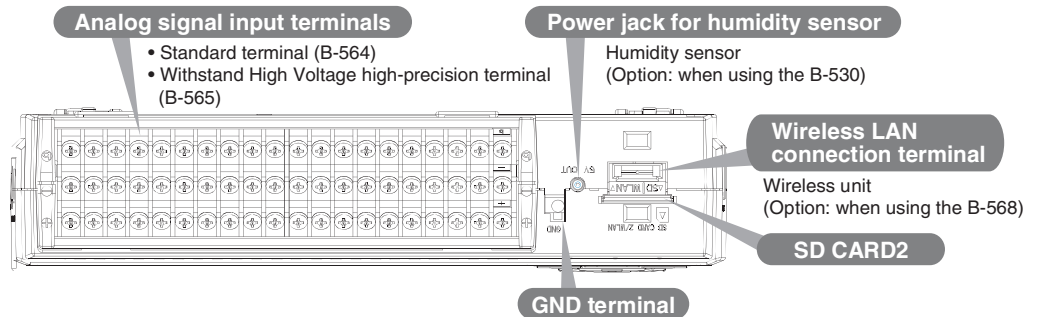

Front Panel

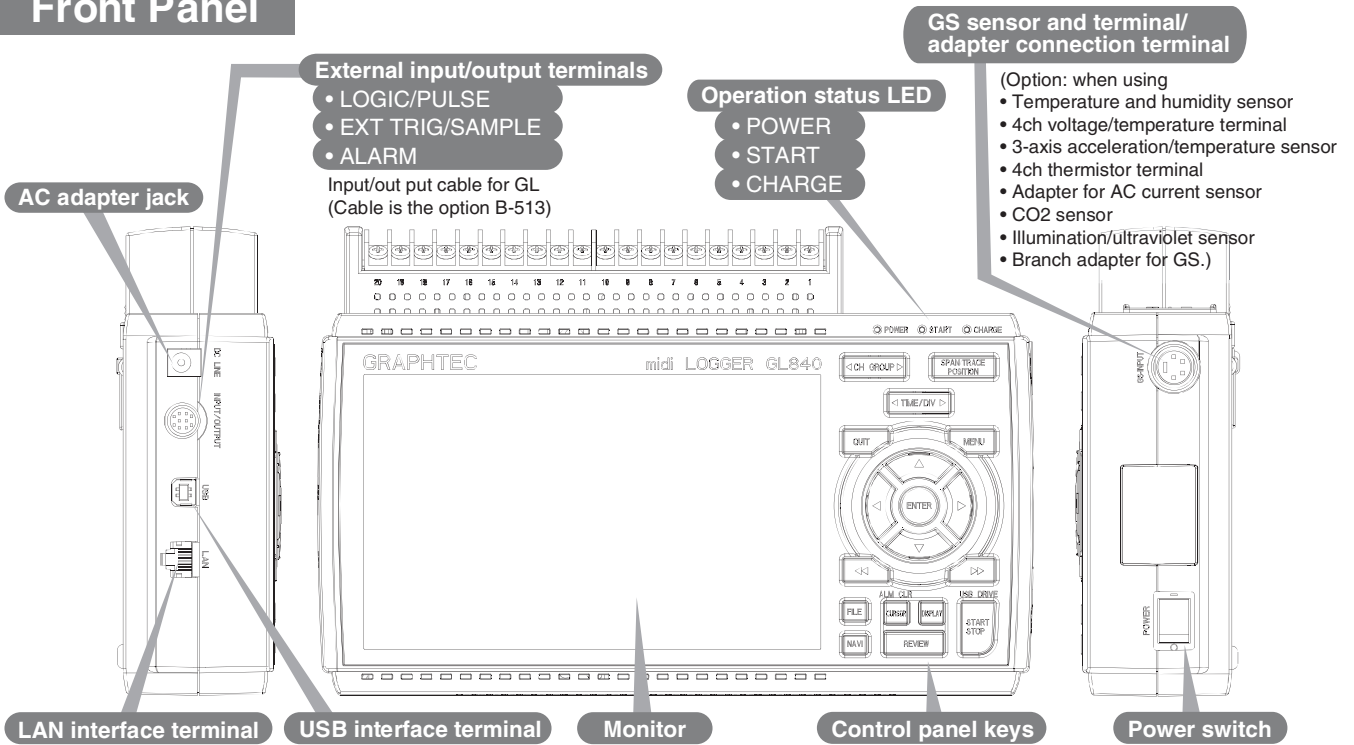

Bottom Panel

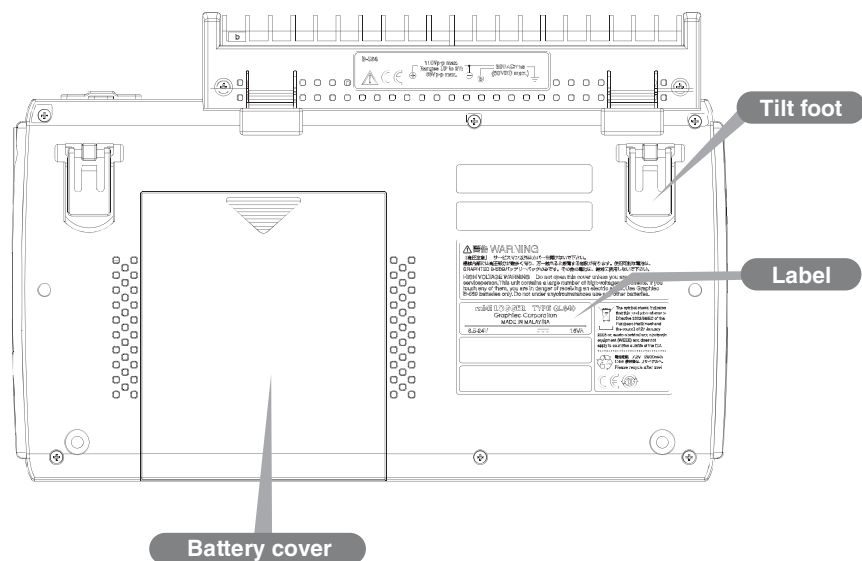

Two battery pack can be installed
(Battery pack is the option B-569)

Connection Procedures

Connect the AC Adapter

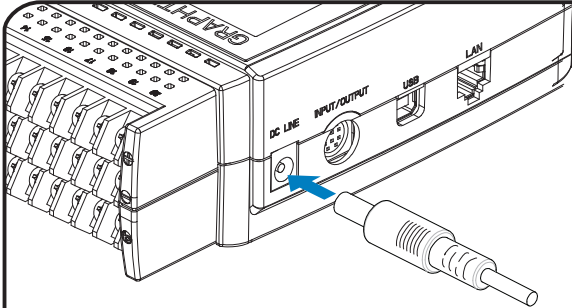

Connect the DC output of the AC adapter to the connector marked as "DC LINE" on the GL840.

Connect the Grounding Cable

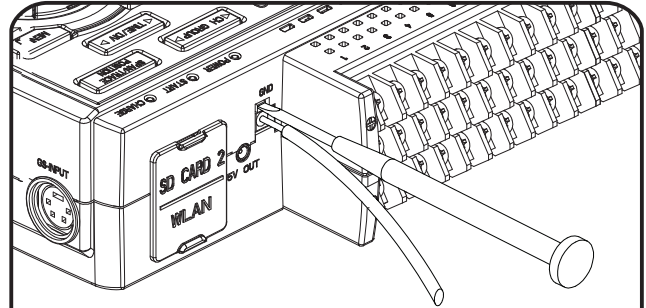

Use a flathead screwdriver to push the button above the GND terminal while connecting the ground cable to the GL840. Connect the other end of the cable to ground.

Connect to the Analog Input Terminals

CH1CH20.

Voltage input
 +
 DC voltage input
 -

Thermocouple input
 +
 -
 Compensation wire is used if it is required.

Resistance temperature detector input
 A +
 B -
 b
 b
 Lead wire resistance should be 10 Ω or less per wire, three wires need to be same length.

Current input
 +
 -
Shunt resistor
 Ex: Current signal is converted to voltage using a shunt resistor.
 For 4 to 20mA current input, install the 250ohms (0.1%)shunt resistor to convert the signal to 1 to 5V. Note: Graphtec offers B-551 250ohm.

CAUTION: Connect wires to the specified channel, the channel number is shown on top of the terminal block.

Connect the External Input/Output Cable

< Signal assignment >

Orange with red dotted line	: 1	Logic/pulse input
Orange with black dotted line	: 2	
Grey with red dotted line	: 3	
Grey with black dotted line	: 4	
White with red dotted line	: 1	Alarm output
White with black dotted line	: 2	
Yellow with red dotted line	: 3	
Yellow with black dotted line	: 4	
Pink with red dotted line	: 1	Trigger input/ external sampling input
Pink with black dotted line	: 2	
Shielded	: GND	

* The B-513 input/output cable for GL (sold separately) is required for connecting input/output signals.
 (For logic/pulse input, alarm output, trigger input and external sampling pulse input)

Internal memory

- The internal memory is displayed as SD1 or SD CARD1
- The internal memory is not removable.

Mounting SD CARD 2

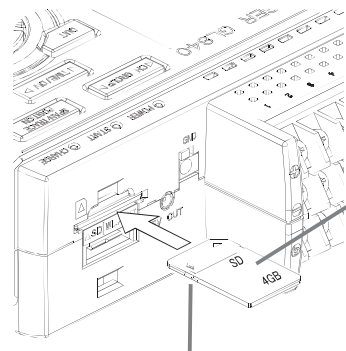

< How to mount >

- (1) Open the protective cover to the SD CARD slot.
- (2) Insert the SD memory card until it clicks and is firmly placed inside the slot.

< How to remove >

- (1) The SD memory card is released by pushing gently on the card. Then, pull to remove the card.

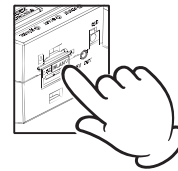

* SD card must be unlocked.

CAUTION: To remove a SD card, push in gently to release the card before pulling.
The POWER LED blinks while GL840 is accessing the SD memory card.

Connect with PC

To connect a PC using a USB cable, attach the supplied ferrite core to the USB cable as shown.

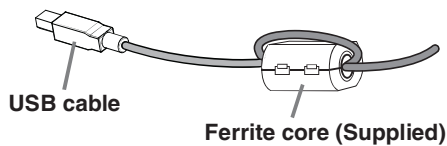

To connect GL840 and PC, use a cable with A-type and B-type connectors.

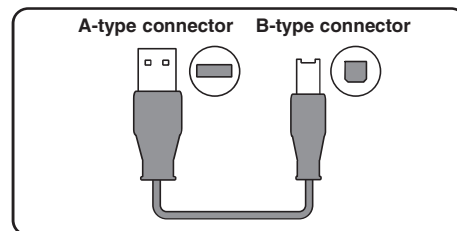

GL840 midi LOGGER complies with the EMC Directive the supplied ferrite core is attached to the USB cable. When connecting with the USB cable, the USB driver must be installed to the PC. For information about how to install, refer to the "USB Driver Installation Manual" in the supplied CD-ROM.

Safety Guide for using GL840

Maximum input voltage of standard terminal (B-564)

If a voltage exceeding the specified value goes into the instrument, the electrical relay in the input will be damaged. Never input voltage level exceeding the specified value at any moment.

< Between +/- terminals(A) >

- Maximum input voltage: 60Vp-p (Ranges set in 20mV to 2V)
110Vp-p (Ranges set in 5V to 100V)

< Between Channel to channel (B) >

- Maximum input voltage: 60Vp-p
- Withstand voltage: 350 Vp-p at 1 minute

< Between Channel to GND (C) >

- Maximum input voltage: 60Vp-p
- Withstand voltage: 350 Vp-p at 1 minute

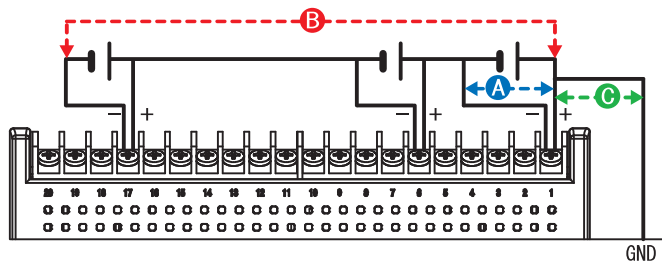

Maximum input voltage of Withstand High Voltage high-precision terminal (B-565)

If a voltage exceeding the specified value goes into the instrument, the electrical relay in the input will be damaged. Never input voltage level exceeding the specified value at any moment.

< Between +/- terminals(A) >

- Maximum input voltage: 60Vp-p (Ranges set in 20mV to 2V)
110Vp-p (Ranges set in 5V to 100V)

< Between Channel to channel (B) >

- Maximum input voltage: 600Vp-p
- Withstand voltage: 600Vp-p

< Between Channel to GND (C) >

- Maximum input voltage: 300Vp-p
- Withstand voltage: 2300 VACrms at 1 minute

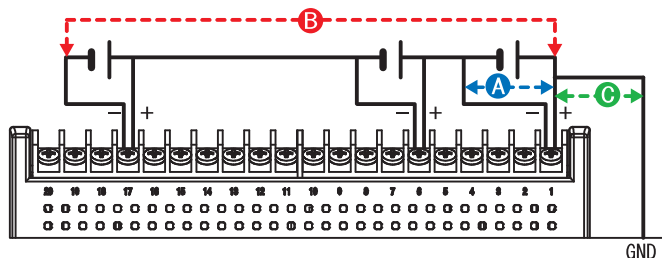

Warm-up

GL840 requires approximately 30 minutes warm-up time to deliver the optimum performance.

Unused channels

The analog input section can frequently have cases of impedance. Left open, measured value may fluctuate due to noise. To rectify, set unused channels to "Off" in the AMP setting menu or short the + and -- terminals for better result.

Noise countermeasures

If measured values fluctuate due to extraneous noise, run the following countermeasures. (Results may vary according to types of noise issues.)

Ex 1 : Connect the GL840's GND input to ground.

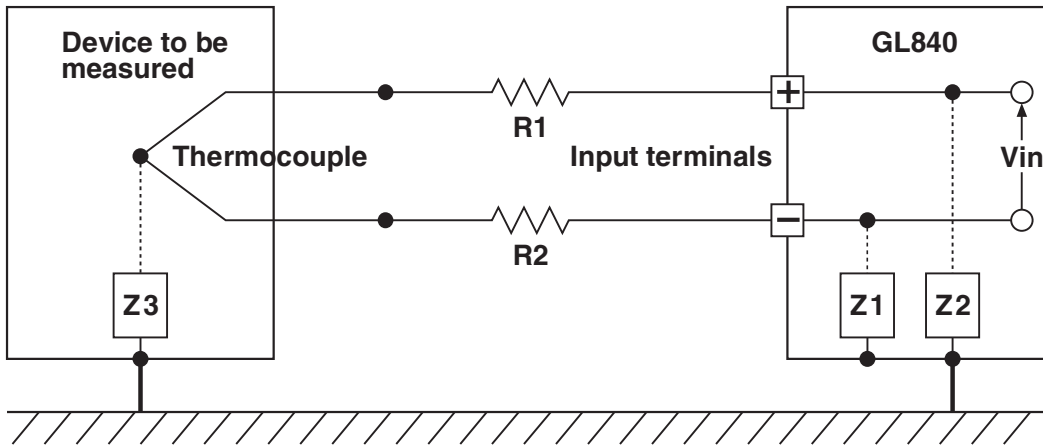

Ex 2 : Connect GL840's GND to measurement object's GND.

Ex 3 : Operate GL840 with batteries (Option: two B-569 batteries).

Ex 4 : In the AMP settings menu, set filter to any setting other than "OFF".

Ex 5: Set the sampling interval which enables GL840's digital filter (see table below).

Number of Measuring Channels *1	Allowed Sampling Interval	Sampling Interval which enables Digital Filter
1 Channel or less	10 msec or slower *2	50 msec or slower
2 Channels or less	20 msec or slower *2	125 msec or slower
5 Channels or less	50 msec or slower *2	250 msec or slower
10 Channels or less	100 msec or slower	500 msec or slower
11 to 20 Channels	200 msec or slower	1 sec or slower
21 to 50 Channels	500 msec or slower	2 sec or slower
51 to 100 Channels	1 sec or slower	5 sec or slower
101 to 200 Channels	2 sec or slower	10 sec or slower

*1 Number of Measuring Channels is the number of active channels in which input settings are set to a value and NOT to "OFF".

*2 Temperature are not measured when the sampling interval is set to 50 ms or faster.

In the "OTHER" menu, the commercial power frequency to be used must be set.

Set the AC power frequency to be used.

Select items	Description
50 Hz	Area where the power frequency is 50 Hz
60 Hz	Area where the power frequency is 60 Hz

Descriptions of the Control Panel Keys

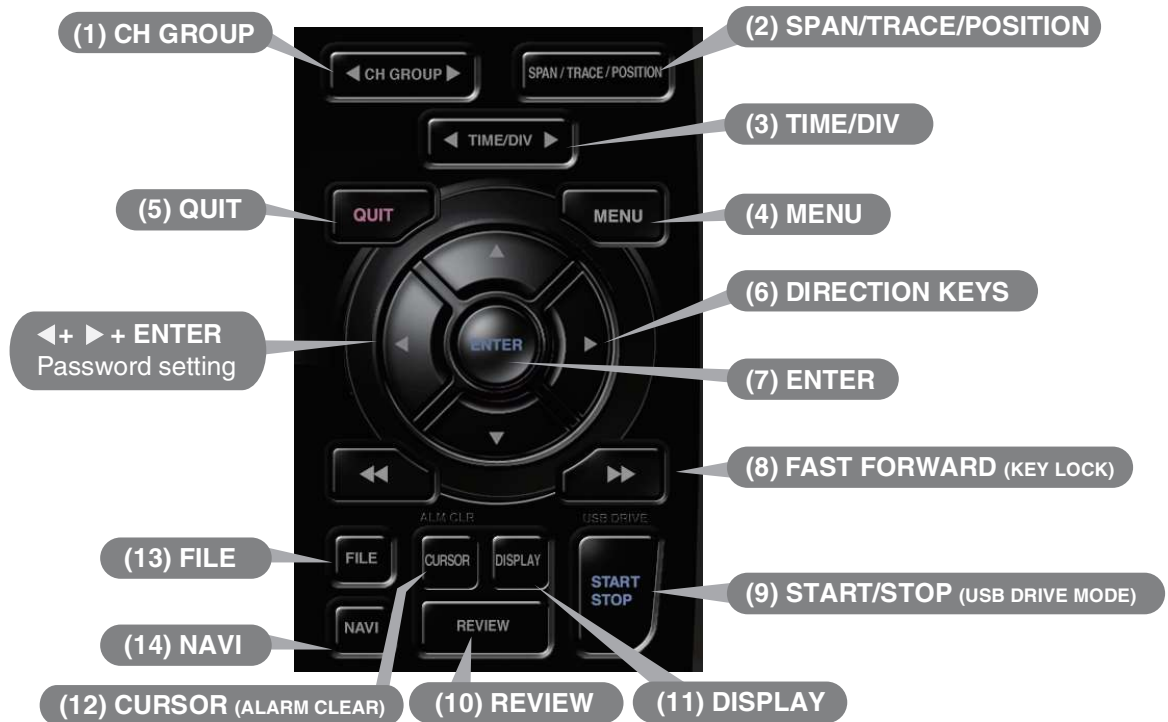

1. CH GROUP

Push the key to switch to the next group consisting of 10 channels.

Push the ◀ key to switch to the previous group.

Push the ▶ key to switch to the following group.

* When installing the GS sensor and terminal/module (sold separately), the following group display is viewed.

2. SPAN/TRACE/POSITION

The SPAN, TRACE and POSITION keys set the range, display, and position settings for individual channels. When the key is pushed, the display mode changes in the sequence shown below. Use the ▲ and ▼ keys to select the channel, and the ◀ and ▶ keys to change the setting values.

Key Pointers

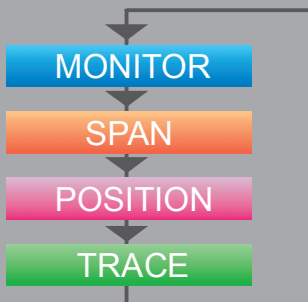

Displays digital values (default).

Change the span settings (change the waveform amplitude).

Change the position settings (adjust the upper and lower values of the waveform).

Change the trace settings (set the waveform display to On or Off).

* If the QUIT key is pushed when the GL840 is in the SPAN, TRACE, or POSITION mode, the display returns to MONITOR mode.

3. TIME/DIV

Push the [TIME/DIV] key to change the time axis display range on the waveform screen.

4. MENU

Push the [MENU] key to open a setup menu. As you push the setup screen tabs change in the sequence shown below as you push the [MENU] key.

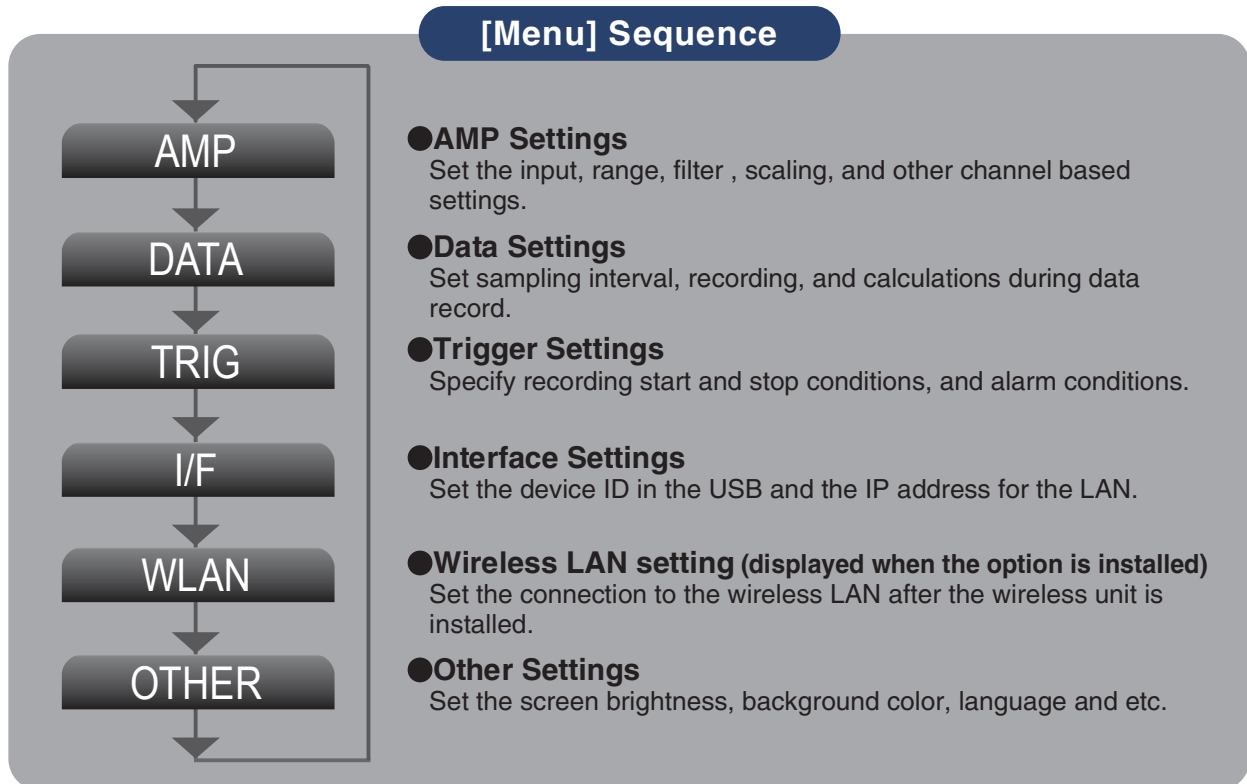

5. QUIT (LOCAL)

Push the [QUIT] key to cancel the settings and return to default status. When you cancel the connection on the application, the GL840 is automatically sent back to local mode. If local mode is not entered, push the [QUIT] key.

6. Keys (DIRECTION KEYS)

Direction key are used to select menu setup items, to make span settings in the digital display area, or to move the cursors during a data replay operation.

7. ENTER

Push the [ENTER] key to submit the setting and to confirm your settings.

8. Keys (KEY LOCK)

Fast forward and rewind keys are used to move the cursor quickly during replay or change operation. Hold down both keys simultaneously for at least two seconds to lock the key buttons. To cancel key lock status, push them again for at least two seconds.

The key lock status can be confirmed by the status of the key lock lamp on the monitor.

* Pushing these keys simultaneously with the ◀ key + ENTER + ▶ key enables password protection for the key lock operation.

9. START/STOP (USB DRIVE MODE)

Push the [START/STOP] key to initiate start and stop of recording while the GL840 is in the Free Running status.

If the key is pushed while turning the power to the GL840 on the unit will switch from the USB connection mode to USB DRIVE mode.

* For more information about the Drive Mode of the USB, refer to the User's Manual in the supplied CD.

10. REVIEW

Push the [REVIEW] key to replay recorded data. If the GL840 is in the Free Running status, data files that have already been recorded will be replayed. If the GL840 is still recording data, the data is replayed in a 2-screen format.

* A data replay operation will not be performed if data has not been recorded.

11. DISPLAY

Push the [DISPLAY] key

Key Pointers

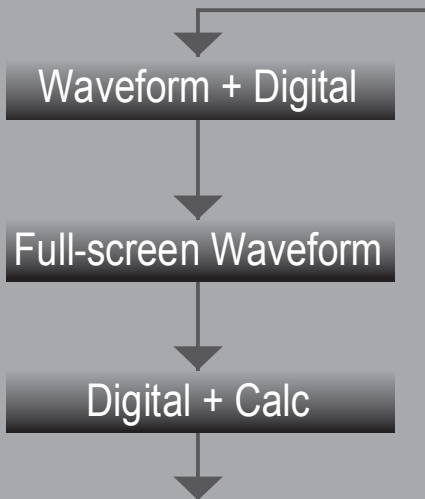

●Waveform + Digital

Default screen when the GL840 is initially turned on with , both waveforms and digital values. The screen settings can also be changed by using the [SPAN/TRACE/POSITION] .

●Full-screen Waveform

Displays waveform only in the full-screen.

●Digital + Calc

Displays large-size digital values and two types of calculation processing results. The calculation settings are made in the "DATA" menu.

Use the ◀◀ key or ▶▶ key to switch digital display mode. (available digital channel displays:2,4,10).

* For more information, refer to the User's Manual in the supplied CD.

12. CURSOR (ALARM CLEAR)

Push the [CURSOR] key to switch between the A and B cursors during data replay. If the Alarm setting has been specified as "Alarm Hold", push the key to clear the alarm.

The alarm settings are made in the "TRIG" menu.

13. FILE

This is used to operate the internal memory (SD1) and SD memory card (SD2), or for file operation, screen copy, and save/load current settings.

14. NAVI

When this key is pressed during free-running, you can perform the setting easily on the menus of the easy capture setting, easy trigger setting, and wireless LAN connection setting (available only when the wireless unit is inserted.).

Descriptions of the Menu Screens

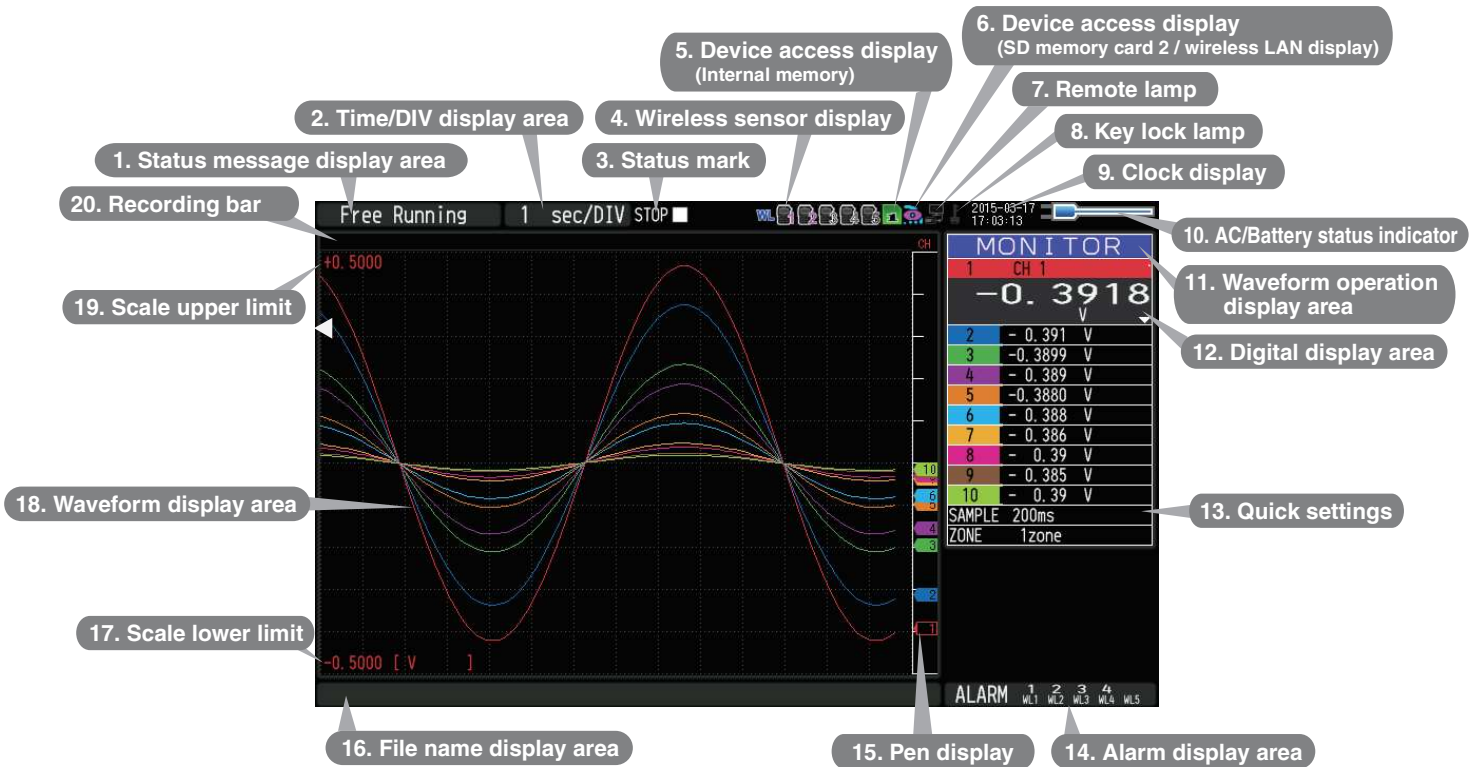

- 1. Status message display area** : Displays the operating status.
- 2. Time/DIV display area** : Displays the current time scale.
- 3. Status mark** : Displays the status mark.
- 4. Wireless sensor display**: Displayed when connecting the GL100-WL (GS sensor and terminal / module connection) to the wireless LAN.
- 5. Device access display (Internal memory)** : Displayed in red when accessing the internal memory (SD1).
- 6. Device access display (SD memory card 2 / wireless LAN display)** : Displayed in red when accessing the SD memory card (SD2). When the SD memory card (SD2) is inserted, this is displayed in green. (When connecting to the wireless LAN as a child unit, the radio field intensity of the base unit is displayed. When setting to the base unit, the number of child units (wireless sensor) which are connects to the GL840 are displayed.)
- 7. Remote lamp** : Displays the remote status. (Yellow = Remote status, white = Local status)
- 8. Key lock lamp** : Displays the key lock status. (Red = keys locked, white = not locked)
- 9. Clock display** : Displays the current date and time.
- 10. AC/Battery status indicator** : Displays the following icons to indicate the operating status of the AC power and the battery. (see right figure)
Note: Use this indicator as a guideline because remaining battery power is an estimate.
This indicator does not guarantee the operating time with battery.
- 11. Waveform operation display area** : Displays the mode selected by the [SPAN/TRACE/POSITION] key.
- 12. Digital display area** : Displays the input values for each channel. The ▲ and ▼ keys can be used to select the active channel (enlarged display). The selected active channel is displayed at the very top of the waveform display.

Status mark

STOP ■	Free Running status
REC ●	Trigger waiting status record end status
REC ●	Recording status
PLAY ▶	Data replay status

Status icon

Radio field intensity display of base unit (5 stages from Strong to Weak)

When setting to base unit: The number of child units which are connecting to the GL840 is displayed.

Wireless sensor unregistration display
Wireless sensor registration / unrecognition display
Wireless sensor registration / recognition display

AC/Battery Indicator

When the AC power supply is being used

	Battery power: 100 - 91%
	Battery power: 90 - 61%
	Battery power: 60 - 31%
	Battery power: 30 - 11%
	Battery power: 10% or less

- 13. **Quick settings** : Displays items that can be easily set. The ▲ and ▼ keys can be used to activate make a Quick settings item, and the ◀ and ▶ keys to change the values.
- 14. **Alarm display area** : Displays the status of the alarm output. (Red = alarm generated, white = alarm not generated)
- 15. **Pen display** : Displays the signal positions, trigger positions, and alarm ranges for each channel. (see right figure)
- 16. **File name display area** : Displays the recording file name during the recording operation.
When data is being replayed, the display position and cursor information are displayed here.
- 17. **Scale lower limit** : Displays the lower limit of the scale of the currently active channel.
- 18. **Waveform display area** : The input signal waveforms are displayed here.
- 19. **Scale upper limit** : Displays the upper limit of the scale of the current active channel.
- 20. **Recording bar** : Indicates the remaining capacity of the record media during recording.
When data is being replayed, the display position and cursor information are displayed here.

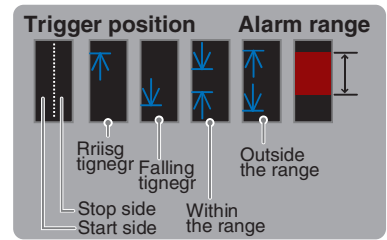

Measurement Procedure

A basic information on the data recording process:
Preparations -> Setup -> Record -> Replay.

Example: Voltage and temperature measurements.

- Purpose : To measure voltage and the temperature of the target
- Temperature Range : T type Thermocouple, 100°C
- Voltage range : 1V
- Sampling interval : 1 sec
- Data save destination : Internal memory (SD1)

1. Preparations : Hardware set up for Data Recording

1. Connect Thermocouple to CH 1 terminal (Temperature).
2. Connect wire to CH 2 terminal (Voltage).
3. Connect the AC power supply.
4. Turn the power supply on.



2. Setup : Menu Operation

Select the setting for only the channels being used. Make sure to turn off unused channels. It is unnecessary to change all setting from the factory default.

Key Pointers

Basic Setup Menu Operation

The \blacktriangle , \blacktriangledown , \blacktriangleleft , \blacktriangleright , [ENTER], and [QUIT] keys are used to set the condition on the setup menu. The current position of the cursor on the setup menu is displayed in green. Use the \blacktriangle , \blacktriangledown , \blacktriangleleft , \blacktriangleright keys to move the cursor. When the [ENTER] key is pushed at the cursor position, a selection menu or a box of entering value for selected item is displayed. If you push the [QUIT] key, the screen closes and the settings are canceled.

●Examples of selection menu operations (AMP screen)

1. Use the \blacktriangledown , \blacktriangle , \blacktriangleleft , \blacktriangleright keys to move the cursor to the input parameter of CH 1 and then push the [ENTER] key.

CH :	Input	Sensor	Range
ALL: M	DC		2 V
1: M	DC		2 V
2: M	Off		5 V
3: M	DC		2 V
4: M	TEMP		5 V
5: M	RH		2 V
6: M	UL		5 V

2. A selection menu is displayed when the [ENTER] key is pushed. Use the \blacktriangledown and \blacktriangle keys to select "TEMP."

CH :	Input	Sensor	Range
ALL: M	DC		2 V
1: M	DC		2 V
2: M	Off		5 V
3: M	DC		2 V
4: M	TEMP		5 V
5: M	RH		2 V
6: M	UL		5 V

3. Push the [ENTER] key to confirm your selection.

CH :	Input	Sensor	Range
ALL: M	TEMP	TC-K	2000 °C
1: M	TEMP	TC-K	2000 °C
2: M	DC		5 V
3: M	DC		2 V
4: M	DC		5 V
5: M	DC		2 V
6: M	DC		5 V

(Note: Select "DC" for voltage measurement, and "Temperature" for temperature measurement.)

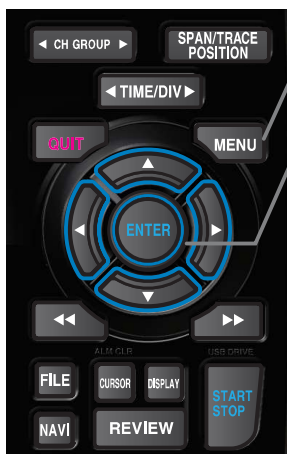

1. Push the [MENU] key to display the setup menu screen.

2. Set Input to "TEMP" and Sensor to "TC-T" for CH1, and set Input to "DC" and Range to "1V" for CH2.

(1) Move the cursor to CH1 "Sensor" and select "TC-T" and then move to "Range" and select "100°C" .

CH :	Input	Sensor	Range	Filter	EU	Misc.
ALL: M	TEMP	TC-T	2000 °C	Off	Off	Off
1: M	TEMP	TC-T	2000 °C	Off	Off	Off
2: M	DC	TC-K	TC-W	Off	Off	Off
3: M	DC	Pt100	Off	Off	Off	Off
4: M	DC	JPt100	Off	Off	Off	Off
5: M	DC	TC-R	Pt1000	Off	Off	Off
6: M	DC	TC-E	Off	Off	Off	Off
7: M	DC	TC-S	Off	Off	Off	Off
8: M	DC	TC-N	Off	Off	Off	Off
9: M	DC	TC-H	Off	Off	Off	Off
10: M	DC		Off	Off	Off	Off

CH :	Input	Sensor	Range	Filter	EU	Misc.
ALL: M	TEMP	TC-T	2000 °C	Off	Off	Off
1: M	TEMP	TC-T	2000 °C	Off	Off	Off
2: M	DC		100 °C	Off	Off	Off
3: M	DC		500 °C	Off	Off	Off
4: M	DC		2000 °C	Off	Off	Off
5: M	DC		1 V	Off	Off	Off
6: M	DC		5 V	Off	Off	Off
7: M	DC		3 V	Off	Off	Off
8: M	DC		50 V	Off	Off	Off
9: M	DC		20 V	Off	Off	Off
10: M	DC		50 V	Off	Off	Off

Select with \blacktriangle , \blacktriangledown and [ENTER] key.

(2) In the same manner, move the cursor to CH2 "Input" and select "DC" and then move to "Range" and select "1V."

3. Select "Off" for all the other channels.

(1) Using the procedure described above, select "Off" for CH 3 to CH 10. Use the [CH GROUP] key to switch to the CH11 to CH20 group.

CH :	Input	Sensor	Range	Filter	EU	Misc.
ALL: M	TEMP	TC-T	100 °C	Off	Off	Off
1: M	TEMP	TC-T	100 °C	Off	Off	Off
2: M	DC		1 V	Off	Off	Off
3: M	Off					
4: M	Off					
5: M	Off					
6: M	Off					
7: M	Off					
8: M	Off					
9: M	Off					
10: M	Off					

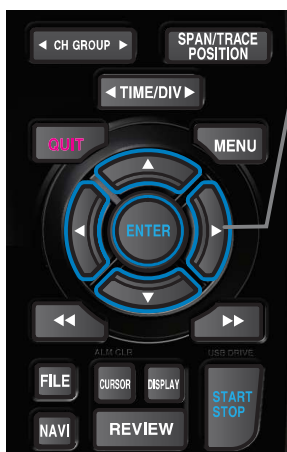

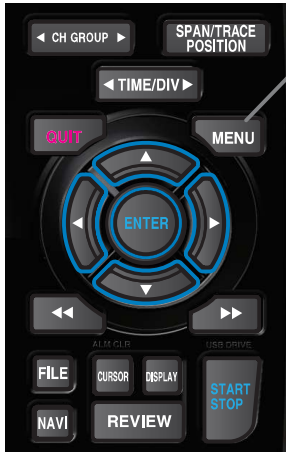

4. Push the [MENU] key and open the "DATA" menu.

Push the [MENU] key. Next, move the cursor to the "DATA" in the "MENU" at the top.

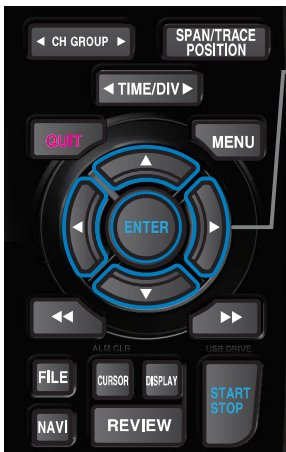
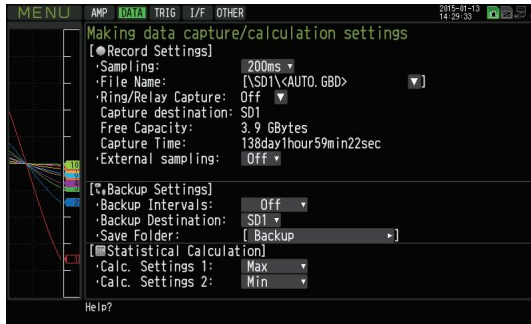

5. Set the sampling interval to "1s".

Move the cursor to "Sampling" and then select "1s".

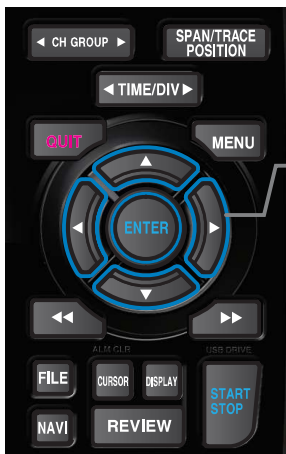
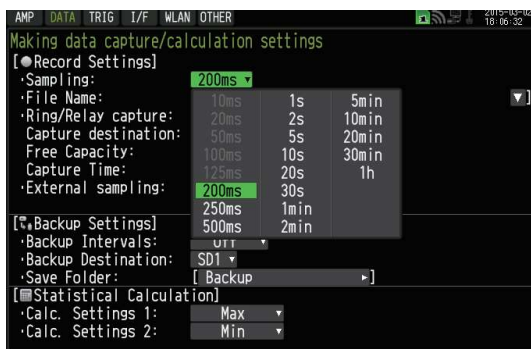

6. Set the Data Recording Medium to "SD memory card".

Here we will use the name "TEST" folder to be created in the internal memory (SD1), and then set the recorded data to be placed inside the "TEST" folder.

- (1) Move the cursor to the File Name parameter and then push the [ENTER] key.
- (2) Move the cursor to the <SD1> item in the following screen, push the [ENTER] key.

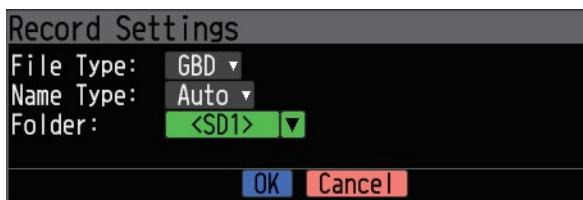

- (3) The data save destination box shown in the following screen opens. In the data saving destination box, set the SD1 as the Record Medium.

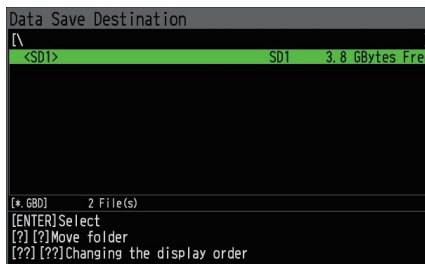

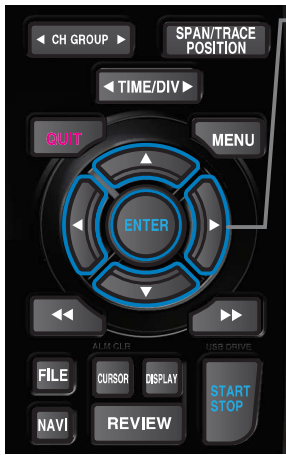

(4) Go to the "SD1" level using the ► key.

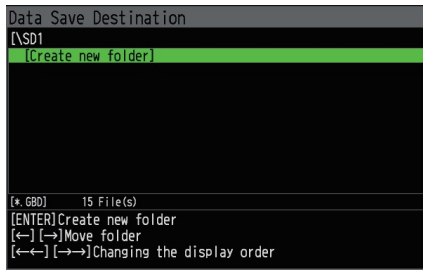

Move the cursor to the "Create New Folder" icon using the ▲▼ keys and then push the [ENTER] key. The Input menu will be displayed.

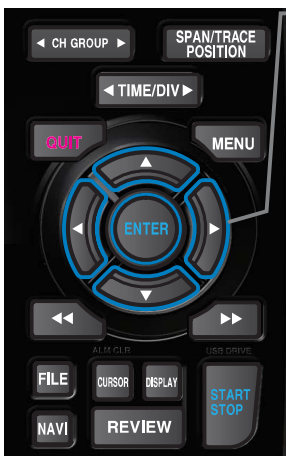

(5) A text input box will be displayed. Create a folder named "TEST".

(1) In the text type select; delete; insert; confirm items, move the cursor to the A using the ◀ and ▶ keys.

(2) The selected text is displayed.

During the text select, move the cursor to the text using the ▲, ▼, ◀ and ▶ keys and then push the [ENTER] key.

Input "TEST", move the cursor to [OK], and then push the [ENTER] key to enter your setting.



Text input box

(1) Select the text type, delete, insert, confirm

(2) Select the character

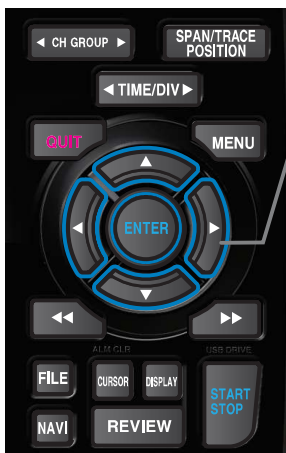

(6) Select the "TEST" folder and then push the [ENTER] key to return to the record setting screen.

(7) Move the cursor to **OK** and then push the [ENTER] key.



Data records using the automatic file naming which includes date and time stamp in the file name located in the internal memory (SD1).

(8) Available space in specified memory and available data recording time are displayed in the lower part of the Record Settings menu.

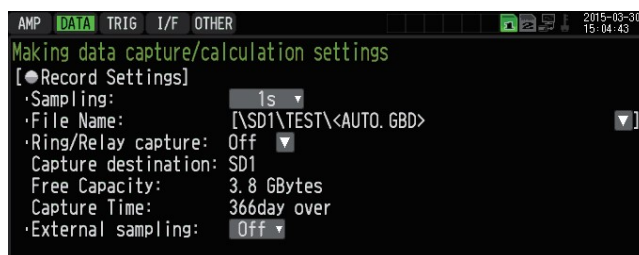

Minimum required setting for data record is now complete.

3. Data record : How to Record

Once required settings are saved, you can record data while it is in process. Recorded data is available for replay.

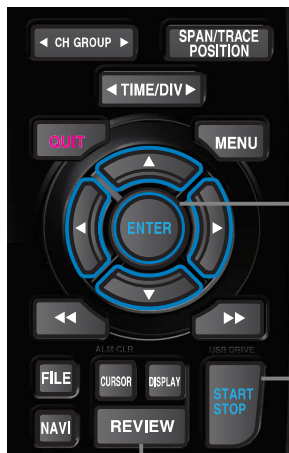

1. Start data recording

- (1) Push the [START/STOP] key.
- (2) A confirmation message is displayed.



- (3) Push the [ENTER] key to start data record.

2. Screen status during data recording

Once data recording starts, progress is visible on the screen. The displayed time counts up or down.

Recording message



elapsed time

remaining time for data record

(The indication becomes ++++ when the available recording time is 9999 hours or more.)

Key Pointers

Recorded Data can be viewed while it is in progress by pressing the [REVIEW] key. Data is available for viewing from the start to the point of real time recording while in progress.

During the replay, arbitrary level values can be viewed by moving the cursor. Return to the data capture screen by pressing the [REVIEW] key again.

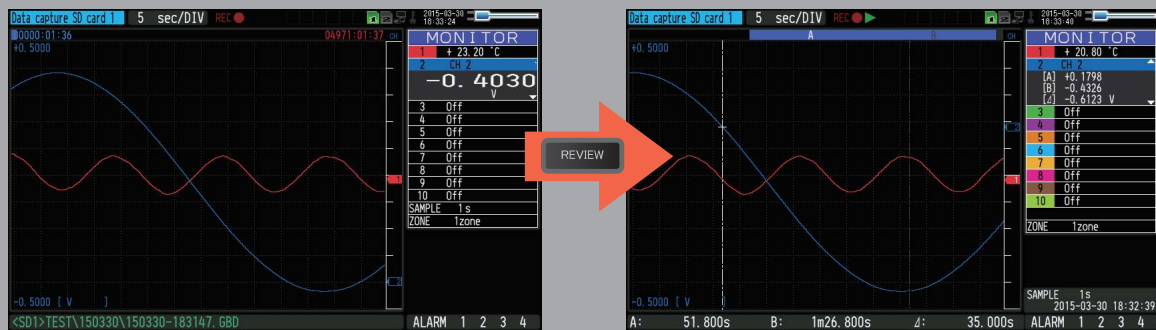

* The [DISPLAY] key allows users to switch between the 1-screen and 2-screen.

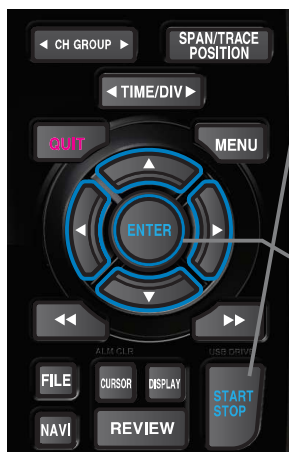

3. Stop recording

Push the [START/STOP] key.

- (1) Push the [START/STOP] key.

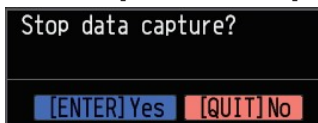

- (2) Confirmation message is displayed. Push the [ENTER] key.
- (3) Recording ends, and the GL840 goes into the Free Running mode.

The operation of data recording is complete.

4. Data Replay : How to Replay Recorded Data

When recording has been completed data is automatically replayed. The automatically replayed data is the data recorded to the internal memory (SD1) which has been set as the data capture destination. Push the [QUIT] key to end the data replay operation.

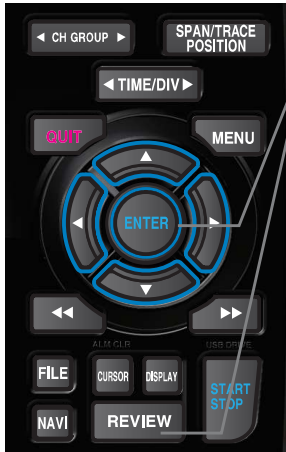

1. Selecting a file to replay

- (1) Push the [REVIEW] key.
- (2) Select data to be reviewed, move the cursor to the [OK] button and [ENTER] key.

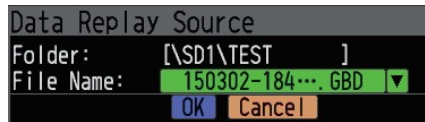

2. Replay screen

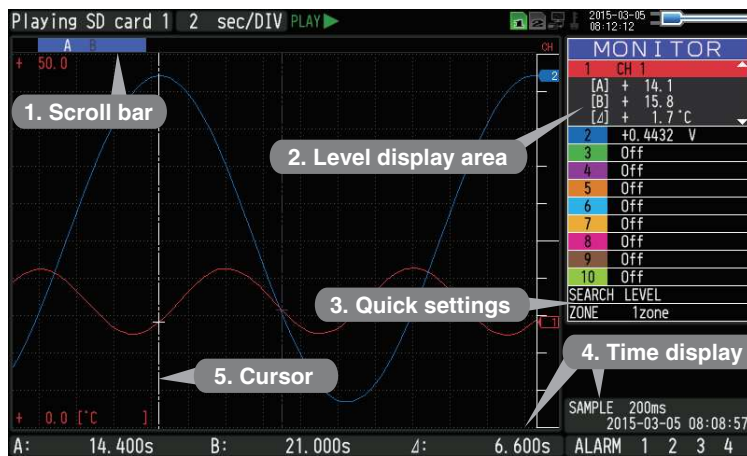

- 1. Scroll bar** : Displays the position within the whole data and the display width.
- 2. Level display area** : Displays the levels of A and B cursors and the difference between the A and B values.
- 3. Quick settings** : Use the ◀▶ keys to search the previous or next level. (Note: Make search settings in the menu.)
- 4. Time display** : Displays the sampling interval and the time of the cursor.
- 5. Cursor** : Displays the cursor. (Note: Push the CURSOR key to switch between A and B cursors.)
Move the cursor using the ◀▶ keys or the ◀◀▶▶ keys.
Desired level values and time can be checked by moving the cursor.

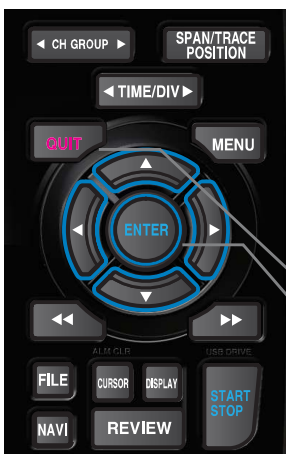

- Push the [QUIT] key to end the data replay operation.
- A confirmation message is displayed. Push the [ENTER] key.

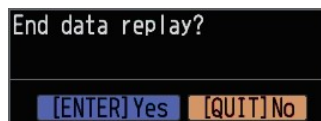

Data replay ends, and the GL840 goes into the Free Running mode.

GL840 has many additional features. Please refer to the following pages for details.

Additional features

The GL840 has various functions that enhances and allows data to be collected and displayed more effectively.

The following three functions describes these details.

Trigger Functions to Control Recording Start/Stop Operations

Trigger functions control the timing of the start of a recording, and the timing of the end of a recording.

Key Pointers

For example...

The trigger function can perform following operations:

- Start recording when the voltage exceeds 1 V
- Stop recording at 1:00 pm
- Perform control via external input



Here recording starts with the condition set as "Start recording when the CH1 temperature exceeds 20°C".

(1) Push the [MENU] key and open the "TRIG" menu.



(2) Move the cursor to "Start Source" and select "Level".



(3) Push the [ENTER] key according to the "Level Settings". The "Trigger Level Settings" screen is displayed. Move the cursor to the "Mode" parameter for the CH1, and then select "H".

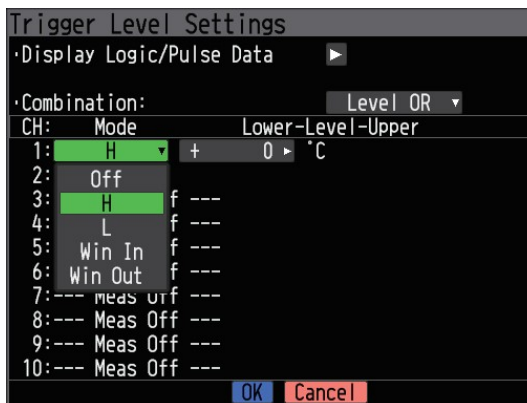

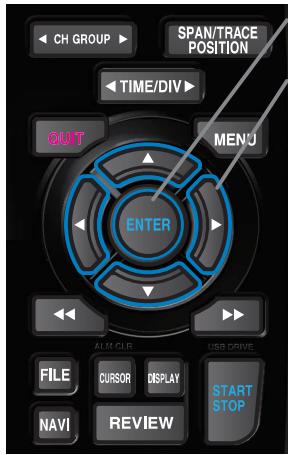

- (4) Move the cursor to the "Level" parameter next to the "Mode" parameter and then push the [ENTER] key.
- (5) The input box shown in the following screen is displayed. Select "20". Use the ◀ and ▶ keys to move to the cursor to the second digit from the right, and the ▲ and ▼ keys to change the value. Push the [ENTER] key.



- Numerical value input box
- Lower and upper limit for setting.
- Waveform area for confirmation
- Use the ▲ and ▼ keys to change the values.
- Use the ◀ and ▶ keys to move the digit.
- Use the [ENTER] key to enter the value.
- Use the [QUIT] key to cancel the setting.

- (6) When the screen changes to the following screen, move the cursor to the **OK** button and then push the [ENTER] key.

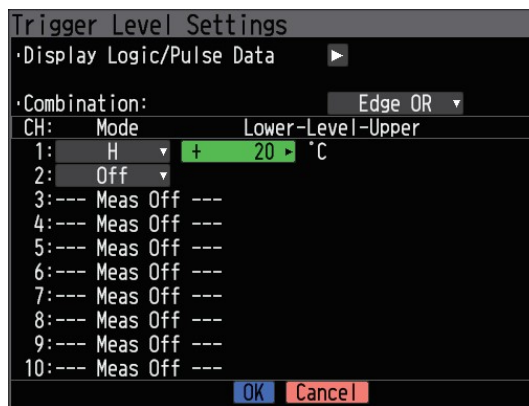

- (7) The screen returns to the TRIG menu screen. Push the [QUIT] key to return the GL840 to the Free Running status.
- (8) Push the [START/STOP] key to start recording. If the trigger condition has not been satisfied, the GL840 goes into the "Armed" status as shown on the following screen.



When the trigger condition is satisfied, the recording starts. The display is changed to the "Data capture SD card 1" .



Key Pointer

The trigger can easily set from the "Easy trigger setting" menu in the navigation display by pushing the [NAVI] key.

Span, Trace and Position Functions to Adjust the Waveform Display

Trigger functions can be used to control the timing of the start of recording, and the timing of the end of recording.

Key Pointers

The span, trace and position operations can be performed while the GL840 is in the Free Running mode, while it is recording data, and while it is replaying data. The changes are applied to the displayed data only, and this change does not affect the recorded data.

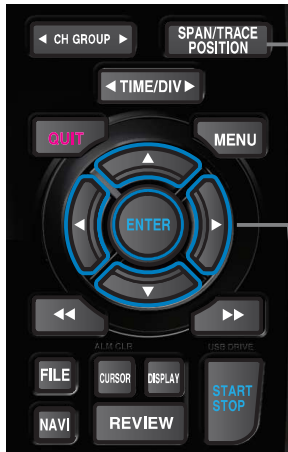

1. How to change the Span setting

The Span parameter is used to adjust the amplitude of the input waveform. This setting is made in the Free Running status.

- (1) Set the displayed span for CH 1 to 110°C.
- (2) Push the [SPAN/TRACE/POSITION] key to select the SPAN mode.

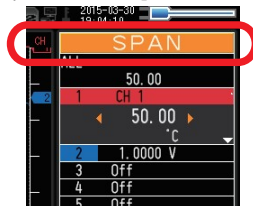

Key Pointers

The currently selected mode (SPAN, TRACE or POSITION) can be checked by looking at the "Waveform Operation Display Area".

- (3) Use the ▲ and ▼ keys to make CH 1 active (display enlarges on the selected channel).
- (4) Use the ◀ and ▶ keys to change the Span value. Here the value for span is set to 110°C. When this setting is changed, the waveform screen scale will be set to "+100.0°C to -10.0°C".



2. How to change the Trace setting.

The Trace parameter can be used to specify the selected waveform to be visible or invisible on the display.

- (1) Push the [SPAN/TRACE/POSITION] key to select the TRACE mode.
- (2) Use the ▲ and ▼ keys to make CH 1 active (enlarged display).
- (3) Use the ◀ and ▶ keys to select Off.

When this setting is changed to OFF, the CH 1 waveform will not be displayed.

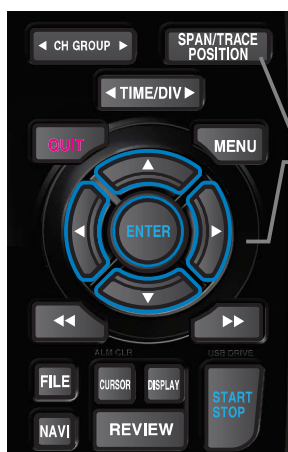

3. How to change the Position setting

The Position parameter is used to adjust the position of displayed waveform that is set by the upper and lower values.

- (1) Push the [SPAN/TRACE/POSITION] key to select the POSITION mode.
- (2) Use the ▲ and ▼ keys to make CH 1 active (enlarged display).
- (3) Use the ◀ and ▶ keys to set the Position value to "+90°C to -20°C".

When this setting has been changed, the waveform screen scale will be set to "+90°C to -20°C".



Specifications

Standard Specifications

Item	Description																				
Number of analog channel	GL840-M or GL840-WV (20ch per 1 terminal or maximum 200ch available with extension unit)																				
External input and output functions	Trigger input and External sampling (1ch), Logic input (4ch) or Pulse input (4ch), Alarm output (4ch)																				
PC interface	Ethernet (10BASE-T/100BASE-TX), USB (HighSpeed supported) provided as standard features																				
Built-in memory device	Internal memory (SD1) : approx. 4GB SD CARD2 slot: 1 (Compatible with SDHC, up to approx. 32GByte memory available) * Possible to save up to 2GB for one file																				
Number of analog channel	10ms/1ch MAX (GBD/CSV format) 10/20/50/100/125/200/250/500ms, 1/2/5/10/20/30sec 1/2/5/10/20/30min, 1hour, External * Allowable setting varies with the input setting and the number of measurement channels.																				
Back-up functions	Setup parameters: EEPROM/Clock: Lithium battery																				
Clock accuracy (ambient temperature 23°C)	±0.002% (approx. 50 seconds per month)																				
Operating environment	0 to 45°C, 5 to 85%RH (0 to 40°C when operated in batteries/15 to 35°C when battery is charging)																				
Power supply	AC adapter : 100 to 240 VAC, 50 to 60 Hz DC input : 8.5 to 24 VDC (26.4 V max.) Battery pack (option) : 7.2 VDC (2900 mAh), two packs required																				
Power consumption	AC power consumption * when using the AC adapter provided as a standard accessory																				
	<table border="1"> <thead> <tr> <th>No</th> <th>Condition</th> <th>Normal</th> <th>During recharging battery</th> </tr> </thead> <tbody> <tr> <td rowspan="2">1</td> <td rowspan="2">When the LCD is on</td> <td>AC100 V</td> <td>24 VA</td> <td>38 VA</td> </tr> <tr> <td>AC240 V</td> <td>35 VA</td> <td>55 VA</td> </tr> <tr> <td rowspan="2">2</td> <td rowspan="2">When the screen saver is operating</td> <td>AC100 V</td> <td>19 VA</td> <td>33 VA</td> </tr> <tr> <td>AC240 V</td> <td>27 VA</td> <td>49 VA</td> </tr> </tbody> </table>	No	Condition	Normal	During recharging battery	1	When the LCD is on	AC100 V	24 VA	38 VA	AC240 V	35 VA	55 VA	2	When the screen saver is operating	AC100 V	19 VA	33 VA	AC240 V	27 VA	49 VA
	No	Condition	Normal	During recharging battery																	
	1	When the LCD is on	AC100 V	24 VA	38 VA																
			AC240 V	35 VA	55 VA																
	2	When the screen saver is operating	AC100 V	19 VA	33 VA																
AC240 V			27 VA	49 VA																	
DC current consumption * Normal condition: LCD brightness is set to MAX.																					
<table border="1"> <thead> <tr> <th>No</th> <th>Condition</th> <th>Normal</th> <th>During recharging battery</th> </tr> </thead> <tbody> <tr> <td>1</td> <td rowspan="2">+24 V</td> <td>When the LCD is on</td> <td>0.36 A</td> <td>0.65 A</td> </tr> <tr> <td>2</td> <td>When the screen saver is operating</td> <td>0.27 A</td> <td>0.56 A</td> </tr> </tbody> </table>	No	Condition	Normal	During recharging battery	1	+24 V	When the LCD is on	0.36 A	0.65 A	2	When the screen saver is operating	0.27 A	0.56 A								
No	Condition	Normal	During recharging battery																		
1	+24 V	When the LCD is on	0.36 A	0.65 A																	
2		When the screen saver is operating	0.27 A	0.56 A																	
Display	7-inch TFT color LCD display (WVGA800 × 480 dots)																				
Display language	Japanese, English, French, German, Chinese, Korean, Russian, Spanish																				
External dimensions (approximate)	GL840-M (with standard terminal): 240 x 158 x 52.5 mm GL840-WV (Withstand High Voltage high-precision terminal): 240 x 166 x 52.5 mm																				
Weight (approximate)	GL840-M (with standard terminal): 1,010g, GL840-WV (Withstand High Voltage high-precision terminal): 1,035 g * AC adapter and battery are not included.																				
Vibration- tested conditions	Equivalent to automobile parts Type 1 category A classification																				

External Input/Output Functions

Item	Description
Input specifications (pulse/logic, trigger/ External sampling)	Maximum input voltage : 0 to +24V (single-ended ground input)
	Input threshold voltage : approximate +2.5 V
	Hysteresis : approximate 0.5 V (+2.5 V to +3 V)
Alarm output specifications	Output format : Open collector output (5 V, 10 k pull-up resistance) * Refer to the User's Manual in the supplied CD-ROM for more information.

Common specification of the terminal in the input section

* The following specifications are common to GL840-M and GL840-WV.

Item		Description
Number of input channels		M3 screw type, 20 channels (maximum 200 channels with extension unit)
Method		Photo MOS relay scanning system, all channels isolated, balanced input
Measurement accuracy	Voltage	20/50/100/200/500 mV, 1/2/5/10/20/50/100 V, 1-5 V F.S.
	Temperature	Thermocouple : K, J, E, T, R, S, B, N, W (WRe5-26)
		Resistance temperature detector : Pt100, JPt100, Pt1000 (IEC751)
		Measurement accuracy : 100°C, 500°C, 2000°C
Humidity	0 to 100% (voltage 0 V to 1 V scaling conversion)	
A/D converter		16-bit Delta-Sigma A/D converter (Effective resolution: approx. 1/40,000 of \pm range)
Temperature coefficient		Gain : 0.01% of F.S./°C * Occurs when sampling speed is 10 ms/20 ms or 50 ms. Zero : 0.02% of F.S./°C
Common mode rejection ratio		At least 90 dB (50/60 Hz; signal source 300 or less)
Noise		At least 48 dB (with +/- terminals shorted)

Specification of input section (GL840-M with standard terminal)

Item	Description																																																																														
Measurement accuracy *1 (23°C \pm 5°C) • When 30 minutes or more have elapsed after power was switched on • Sampling 1 s/20 ch • Filter ON (10) • GND connected	●Voltage : \pm0.1% of F.S. ●Thermocouple *1: Thermocouple diameters T, K: 0.32 , others: 0.65																																																																														
	<table border="1"> <thead> <tr> <th>Type</th> <th>Measurement Temperature Range</th> <th>Measurement Accuracy</th> </tr> </thead> <tbody> <tr> <td rowspan="4">R/S</td> <td>0 TS 100°C</td> <td>\pm5.2°C</td> </tr> <tr> <td>100<TS 300°C</td> <td>\pm3.0°C</td> </tr> <tr> <td>R: 300<TS 1600°C</td> <td>\pm (0.05% of rdg +2.0°C)</td> </tr> <tr> <td>S: 300<TS 1760°C</td> <td>\pm (0.05% of rdg +2.0°C)</td> </tr> <tr> <td rowspan="2">B</td> <td>400 TS 600°C</td> <td>\pm3.5°C</td> </tr> <tr> <td>600<TS 1820°C</td> <td>\pm (0.05% of rdg +2.0°C)</td> </tr> <tr> <td rowspan="2">K</td> <td>-200 TS -100°C</td> <td>\pm (0.05% of rdg +2.0°C)</td> </tr> <tr> <td>-100<TS 1370°C</td> <td>\pm (0.05% of rdg +1.0°C)</td> </tr> <tr> <td rowspan="2">E</td> <td>-200 TS -100°C</td> <td>\pm (0.05% of rdg +2.0°C)</td> </tr> <tr> <td>-100<TS 800°C</td> <td>\pm (0.05% of rdg +1.0°C)</td> </tr> <tr> <td rowspan="2">T</td> <td>-200 TS -100°C</td> <td>\pm (0.1% of rdg +1.5°C)</td> </tr> <tr> <td>-100<TS 400°C</td> <td>\pm (0.1% of rdg +0.5°C)</td> </tr> <tr> <td rowspan="3">J</td> <td>-200 TS -100°C</td> <td>\pm2.7°C</td> </tr> <tr> <td>-100<TS 100°C</td> <td>\pm1.7°C</td> </tr> <tr> <td>100<TS 1100°C</td> <td>\pm (0.05% of rdg +1.0°C)</td> </tr> <tr> <td rowspan="2">N</td> <td>-200 TS <0°C</td> <td>\pm (0.1% of rdg +2.0°C)</td> </tr> <tr> <td>0 TS 1300°C</td> <td>\pm (0.1% of rdg +1.0°C)</td> </tr> <tr> <td>W</td> <td>0 TS 2000°C</td> <td>\pm (0.1% of rdg +1.5°C)</td> </tr> <tr> <td colspan="2"> Reference contact compensation accuracy \pm0.5°C </td> </tr> <tr> <td colspan="2"> ●Resistance temperature detector * 3-wire system </td> </tr> <tr> <td colspan="4"> <table border="1"> <thead> <tr> <th>Type</th> <th>Measurement Temperature Range</th> <th>Applied current</th> <th>Accuracy</th> </tr> </thead> <tbody> <tr> <td>Pt100</td> <td>-200 to 850°C</td> <td>1mA</td> <td>\pm1.0°C</td> </tr> <tr> <td>JPt100</td> <td>-200 to 500°C</td> <td>1mA</td> <td>\pm0.8°C</td> </tr> <tr> <td>Pt1000</td> <td>-200 to 500°C</td> <td>0.3mA</td> <td>\pm0.8°C</td> </tr> </tbody> </table> </td> </tr> <tr> <td rowspan="3">Maximum input voltage</td> <td>Between +/- terminals : 20mV to 2V range (60Vp-p) 5V to 100V range (110Vp-p)</td> </tr> <tr> <td>Between input terminal/input terminal : 60Vp-p</td> </tr> <tr> <td>Between input terminal/GND : 60Vp-p</td> </tr> <tr> <td rowspan="2">Withstand voltage</td> <td>Between input terminal/input terminal : 1 minute at 350Vp-p</td> </tr> <tr> <td>Between input terminal/GND : 1 minute at 350Vp-p</td> </tr> </tbody> </table>	Type	Measurement Temperature Range	Measurement Accuracy	R/S	0 TS 100°C	\pm 5.2°C	100<TS 300°C	\pm 3.0°C	R: 300<TS 1600°C	\pm (0.05% of rdg +2.0°C)	S: 300<TS 1760°C	\pm (0.05% of rdg +2.0°C)	B	400 TS 600°C	\pm 3.5°C	600<TS 1820°C	\pm (0.05% of rdg +2.0°C)	K	-200 TS -100°C	\pm (0.05% of rdg +2.0°C)	-100<TS 1370°C	\pm (0.05% of rdg +1.0°C)	E	-200 TS -100°C	\pm (0.05% of rdg +2.0°C)	-100<TS 800°C	\pm (0.05% of rdg +1.0°C)	T	-200 TS -100°C	\pm (0.1% of rdg +1.5°C)	-100<TS 400°C	\pm (0.1% of rdg +0.5°C)	J	-200 TS -100°C	\pm 2.7°C	-100<TS 100°C	\pm 1.7°C	100<TS 1100°C	\pm (0.05% of rdg +1.0°C)	N	-200 TS <0°C	\pm (0.1% of rdg +2.0°C)	0 TS 1300°C	\pm (0.1% of rdg +1.0°C)	W	0 TS 2000°C	\pm (0.1% of rdg +1.5°C)	Reference contact compensation accuracy \pm 0.5°C		●Resistance temperature detector * 3-wire system		<table border="1"> <thead> <tr> <th>Type</th> <th>Measurement Temperature Range</th> <th>Applied current</th> <th>Accuracy</th> </tr> </thead> <tbody> <tr> <td>Pt100</td> <td>-200 to 850°C</td> <td>1mA</td> <td>\pm1.0°C</td> </tr> <tr> <td>JPt100</td> <td>-200 to 500°C</td> <td>1mA</td> <td>\pm0.8°C</td> </tr> <tr> <td>Pt1000</td> <td>-200 to 500°C</td> <td>0.3mA</td> <td>\pm0.8°C</td> </tr> </tbody> </table>				Type	Measurement Temperature Range	Applied current	Accuracy	Pt100	-200 to 850°C	1mA	\pm 1.0°C	JPt100	-200 to 500°C	1mA	\pm 0.8°C	Pt1000	-200 to 500°C	0.3mA	\pm 0.8°C	Maximum input voltage	Between +/- terminals : 20mV to 2V range (60Vp-p) 5V to 100V range (110Vp-p)	Between input terminal/input terminal : 60Vp-p	Between input terminal/GND : 60Vp-p	Withstand voltage	Between input terminal/input terminal : 1 minute at 350Vp-p	Between input terminal/GND : 1 minute at 350Vp-p
	Type	Measurement Temperature Range	Measurement Accuracy																																																																												
	R/S	0 TS 100°C	\pm 5.2°C																																																																												
		100<TS 300°C	\pm 3.0°C																																																																												
		R: 300<TS 1600°C	\pm (0.05% of rdg +2.0°C)																																																																												
		S: 300<TS 1760°C	\pm (0.05% of rdg +2.0°C)																																																																												
	B	400 TS 600°C	\pm 3.5°C																																																																												
		600<TS 1820°C	\pm (0.05% of rdg +2.0°C)																																																																												
	K	-200 TS -100°C	\pm (0.05% of rdg +2.0°C)																																																																												
		-100<TS 1370°C	\pm (0.05% of rdg +1.0°C)																																																																												
	E	-200 TS -100°C	\pm (0.05% of rdg +2.0°C)																																																																												
		-100<TS 800°C	\pm (0.05% of rdg +1.0°C)																																																																												
	T	-200 TS -100°C	\pm (0.1% of rdg +1.5°C)																																																																												
		-100<TS 400°C	\pm (0.1% of rdg +0.5°C)																																																																												
J	-200 TS -100°C	\pm 2.7°C																																																																													
	-100<TS 100°C	\pm 1.7°C																																																																													
	100<TS 1100°C	\pm (0.05% of rdg +1.0°C)																																																																													
N	-200 TS <0°C	\pm (0.1% of rdg +2.0°C)																																																																													
	0 TS 1300°C	\pm (0.1% of rdg +1.0°C)																																																																													
W	0 TS 2000°C	\pm (0.1% of rdg +1.5°C)																																																																													
Reference contact compensation accuracy \pm 0.5°C																																																																															
●Resistance temperature detector * 3-wire system																																																																															
<table border="1"> <thead> <tr> <th>Type</th> <th>Measurement Temperature Range</th> <th>Applied current</th> <th>Accuracy</th> </tr> </thead> <tbody> <tr> <td>Pt100</td> <td>-200 to 850°C</td> <td>1mA</td> <td>\pm1.0°C</td> </tr> <tr> <td>JPt100</td> <td>-200 to 500°C</td> <td>1mA</td> <td>\pm0.8°C</td> </tr> <tr> <td>Pt1000</td> <td>-200 to 500°C</td> <td>0.3mA</td> <td>\pm0.8°C</td> </tr> </tbody> </table>				Type	Measurement Temperature Range	Applied current	Accuracy	Pt100	-200 to 850°C	1mA	\pm 1.0°C	JPt100	-200 to 500°C	1mA	\pm 0.8°C	Pt1000	-200 to 500°C	0.3mA	\pm 0.8°C																																																												
Type	Measurement Temperature Range	Applied current	Accuracy																																																																												
Pt100	-200 to 850°C	1mA	\pm 1.0°C																																																																												
JPt100	-200 to 500°C	1mA	\pm 0.8°C																																																																												
Pt1000	-200 to 500°C	0.3mA	\pm 0.8°C																																																																												
Maximum input voltage	Between +/- terminals : 20mV to 2V range (60Vp-p) 5V to 100V range (110Vp-p)																																																																														
	Between input terminal/input terminal : 60Vp-p																																																																														
	Between input terminal/GND : 60Vp-p																																																																														
Withstand voltage	Between input terminal/input terminal : 1 minute at 350Vp-p																																																																														
	Between input terminal/GND : 1 minute at 350Vp-p																																																																														

Specification of input section (GL840-WV Withstand High Voltage high-precision terminal)

Item	Description																																																																																																						
Measurement accuracy *1 (23°C ±5°C) • When 30 minutes or more have elapsed after power was switched on • Sampling 1 s/10 ch • Filter ON (10) • GND connected	● Voltage : ± (0.05% of F.S. +10 μV) ● Thermocouple *1: Thermocouple diameters T, K: 0.32 , others: 0.65																																																																																																						
	<table border="1"> <thead> <tr> <th>Type</th> <th>Measurement Temperature Rang</th> <th>Measurement Accuracy</th> </tr> </thead> <tbody> <tr> <td rowspan="4">R/S</td> <td>0 TS 100°C</td> <td>±4.5°C</td> </tr> <tr> <td>100<TS 300°C</td> <td>±3.0°C</td> </tr> <tr> <td>R: 300<TS 1600°C</td> <td>±2.2°C</td> </tr> <tr> <td>S: 300<TS 1760°C</td> <td>±2.2°C</td> </tr> <tr> <td rowspan="2">B</td> <td>400 TS 600°C</td> <td>±3.5°C</td> </tr> <tr> <td>600<TS 1820°C</td> <td>±2.5°C</td> </tr> <tr> <td rowspan="2">K</td> <td>-200 TS -100°C</td> <td>±1.5°C</td> </tr> <tr> <td>-100<TS 1370°C</td> <td>±0.8°C</td> </tr> <tr> <td rowspan="2">E</td> <td>-200 TS -100°C</td> <td>±1.0°C</td> </tr> <tr> <td>-100<TS 800°C</td> <td>±0.8°C</td> </tr> <tr> <td rowspan="2">T</td> <td>-200 TS -100°C</td> <td>±1.5°C</td> </tr> <tr> <td>-100<TS 400°C</td> <td>±0.6°C</td> </tr> <tr> <td rowspan="3">J</td> <td>-200 TS -100°C</td> <td>±1.0°C</td> </tr> <tr> <td>-100<TS 100°C</td> <td>±0.8°C</td> </tr> <tr> <td>100<TS 1100°C</td> <td>±0.6°C</td> </tr> <tr> <td rowspan="2">N</td> <td>-200 TS <0°C</td> <td>±2.2°C</td> </tr> <tr> <td>0 TS 1300°C</td> <td>±1.0°C</td> </tr> <tr> <td>W</td> <td>0 TS 2000°C</td> <td>±1.8°C</td> </tr> <tr> <td colspan="2">Reference contact compensation accuracy</td> <td>±0.3°C</td> </tr> <tr> <td colspan="3"> ● Resistance temperature detector * 3-wire system </td> </tr> <tr> <td colspan="4"> <table border="1"> <thead> <tr> <th>Type</th> <th>Measurement Temperature Range</th> <th>Applied current</th> <th>Accuracy</th> </tr> </thead> <tbody> <tr> <td rowspan="3">Pt100</td> <td>-200 TS 100°C</td> <td rowspan="3">1mA</td> <td>±0.6°C</td> </tr> <tr> <td>100<TS 500°C</td> <td>±0.8°C</td> </tr> <tr> <td>500<TS 850°C</td> <td>±1.0°C</td> </tr> <tr> <td rowspan="2">JPt100</td> <td>-200 TS 100°C</td> <td rowspan="2">1mA</td> <td>±0.6°C</td> </tr> <tr> <td>100<TS 500°C</td> <td>±0.8°C</td> </tr> <tr> <td rowspan="2">Pt1000</td> <td>-200 TS 100°C</td> <td rowspan="2">0.3mA</td> <td>±0.6°C</td> </tr> <tr> <td>100<TS 500°C</td> <td>±0.8°C</td> </tr> </tbody> </table> </td> </tr> <tr> <td rowspan="3">Maximum input voltage</td> <td colspan="3">Between +/- terminals : 20mV to 2V range (60Vp-p)</td> </tr> <tr> <td colspan="3">5V to 100V range (110Vp-p)</td> </tr> <tr> <td colspan="3">Between input terminal/input terminal : 600Vp-p</td> </tr> <tr> <td rowspan="2">Withstand voltage</td> <td colspan="3">Between input terminal/GND : 300Vp-p</td> </tr> <tr> <td colspan="3">Between input terminal/input terminal : 1 minute at 600Vp-p</td> </tr> <tr> <td></td> <td colspan="3">Between input terminal/GND : 2300 VACrms 1 minute</td> </tr> </tbody> </table>	Type	Measurement Temperature Rang	Measurement Accuracy	R/S	0 TS 100°C	±4.5°C	100<TS 300°C	±3.0°C	R: 300<TS 1600°C	±2.2°C	S: 300<TS 1760°C	±2.2°C	B	400 TS 600°C	±3.5°C	600<TS 1820°C	±2.5°C	K	-200 TS -100°C	±1.5°C	-100<TS 1370°C	±0.8°C	E	-200 TS -100°C	±1.0°C	-100<TS 800°C	±0.8°C	T	-200 TS -100°C	±1.5°C	-100<TS 400°C	±0.6°C	J	-200 TS -100°C	±1.0°C	-100<TS 100°C	±0.8°C	100<TS 1100°C	±0.6°C	N	-200 TS <0°C	±2.2°C	0 TS 1300°C	±1.0°C	W	0 TS 2000°C	±1.8°C	Reference contact compensation accuracy		±0.3°C	● Resistance temperature detector * 3-wire system			<table border="1"> <thead> <tr> <th>Type</th> <th>Measurement Temperature Range</th> <th>Applied current</th> <th>Accuracy</th> </tr> </thead> <tbody> <tr> <td rowspan="3">Pt100</td> <td>-200 TS 100°C</td> <td rowspan="3">1mA</td> <td>±0.6°C</td> </tr> <tr> <td>100<TS 500°C</td> <td>±0.8°C</td> </tr> <tr> <td>500<TS 850°C</td> <td>±1.0°C</td> </tr> <tr> <td rowspan="2">JPt100</td> <td>-200 TS 100°C</td> <td rowspan="2">1mA</td> <td>±0.6°C</td> </tr> <tr> <td>100<TS 500°C</td> <td>±0.8°C</td> </tr> <tr> <td rowspan="2">Pt1000</td> <td>-200 TS 100°C</td> <td rowspan="2">0.3mA</td> <td>±0.6°C</td> </tr> <tr> <td>100<TS 500°C</td> <td>±0.8°C</td> </tr> </tbody> </table>				Type	Measurement Temperature Range	Applied current	Accuracy	Pt100	-200 TS 100°C	1mA	±0.6°C	100<TS 500°C	±0.8°C	500<TS 850°C	±1.0°C	JPt100	-200 TS 100°C	1mA	±0.6°C	100<TS 500°C	±0.8°C	Pt1000	-200 TS 100°C	0.3mA	±0.6°C	100<TS 500°C	±0.8°C	Maximum input voltage	Between +/- terminals : 20mV to 2V range (60Vp-p)			5V to 100V range (110Vp-p)			Between input terminal/input terminal : 600Vp-p			Withstand voltage	Between input terminal/GND : 300Vp-p			Between input terminal/input terminal : 1 minute at 600Vp-p				Between input terminal/GND : 2300 VACrms 1 minute		
	Type	Measurement Temperature Rang	Measurement Accuracy																																																																																																				
	R/S	0 TS 100°C	±4.5°C																																																																																																				
		100<TS 300°C	±3.0°C																																																																																																				
		R: 300<TS 1600°C	±2.2°C																																																																																																				
		S: 300<TS 1760°C	±2.2°C																																																																																																				
	B	400 TS 600°C	±3.5°C																																																																																																				
		600<TS 1820°C	±2.5°C																																																																																																				
	K	-200 TS -100°C	±1.5°C																																																																																																				
		-100<TS 1370°C	±0.8°C																																																																																																				
	E	-200 TS -100°C	±1.0°C																																																																																																				
		-100<TS 800°C	±0.8°C																																																																																																				
	T	-200 TS -100°C	±1.5°C																																																																																																				
		-100<TS 400°C	±0.6°C																																																																																																				
	J	-200 TS -100°C	±1.0°C																																																																																																				
		-100<TS 100°C	±0.8°C																																																																																																				
		100<TS 1100°C	±0.6°C																																																																																																				
	N	-200 TS <0°C	±2.2°C																																																																																																				
		0 TS 1300°C	±1.0°C																																																																																																				
W	0 TS 2000°C	±1.8°C																																																																																																					
Reference contact compensation accuracy		±0.3°C																																																																																																					
● Resistance temperature detector * 3-wire system																																																																																																							
<table border="1"> <thead> <tr> <th>Type</th> <th>Measurement Temperature Range</th> <th>Applied current</th> <th>Accuracy</th> </tr> </thead> <tbody> <tr> <td rowspan="3">Pt100</td> <td>-200 TS 100°C</td> <td rowspan="3">1mA</td> <td>±0.6°C</td> </tr> <tr> <td>100<TS 500°C</td> <td>±0.8°C</td> </tr> <tr> <td>500<TS 850°C</td> <td>±1.0°C</td> </tr> <tr> <td rowspan="2">JPt100</td> <td>-200 TS 100°C</td> <td rowspan="2">1mA</td> <td>±0.6°C</td> </tr> <tr> <td>100<TS 500°C</td> <td>±0.8°C</td> </tr> <tr> <td rowspan="2">Pt1000</td> <td>-200 TS 100°C</td> <td rowspan="2">0.3mA</td> <td>±0.6°C</td> </tr> <tr> <td>100<TS 500°C</td> <td>±0.8°C</td> </tr> </tbody> </table>				Type	Measurement Temperature Range	Applied current	Accuracy	Pt100	-200 TS 100°C	1mA	±0.6°C	100<TS 500°C	±0.8°C	500<TS 850°C	±1.0°C	JPt100	-200 TS 100°C	1mA	±0.6°C	100<TS 500°C	±0.8°C	Pt1000	-200 TS 100°C	0.3mA	±0.6°C	100<TS 500°C	±0.8°C																																																																												
Type	Measurement Temperature Range	Applied current	Accuracy																																																																																																				
Pt100	-200 TS 100°C	1mA	±0.6°C																																																																																																				
	100<TS 500°C		±0.8°C																																																																																																				
	500<TS 850°C		±1.0°C																																																																																																				
JPt100	-200 TS 100°C	1mA	±0.6°C																																																																																																				
	100<TS 500°C		±0.8°C																																																																																																				
Pt1000	-200 TS 100°C	0.3mA	±0.6°C																																																																																																				
	100<TS 500°C		±0.8°C																																																																																																				
Maximum input voltage	Between +/- terminals : 20mV to 2V range (60Vp-p)																																																																																																						
	5V to 100V range (110Vp-p)																																																																																																						
	Between input terminal/input terminal : 600Vp-p																																																																																																						
Withstand voltage	Between input terminal/GND : 300Vp-p																																																																																																						
	Between input terminal/input terminal : 1 minute at 600Vp-p																																																																																																						
	Between input terminal/GND : 2300 VACrms 1 minute																																																																																																						

Installation Guide

For the installation procedure of the GL840 application software (USB driver / GL100_240_840-APS), refer to the "Application Software Manual" included in the attached CD-ROM.

GRAPHTEC

Specifications are subject to change without notice.

GL840 Quick Start Guide
(GL840-UM-852)

April 10, 2018
1st edition-01

Publisher GRAPHTEC CORPORATION



Instrumentation Devices Srl
Via Acquanera 29 - 22100 COMO (Italy)
ph +39 031 525 391- fax +39 031 507 984
info@instrumentation.it - www.instrumentation.it