

Move into the future with reliable measurements

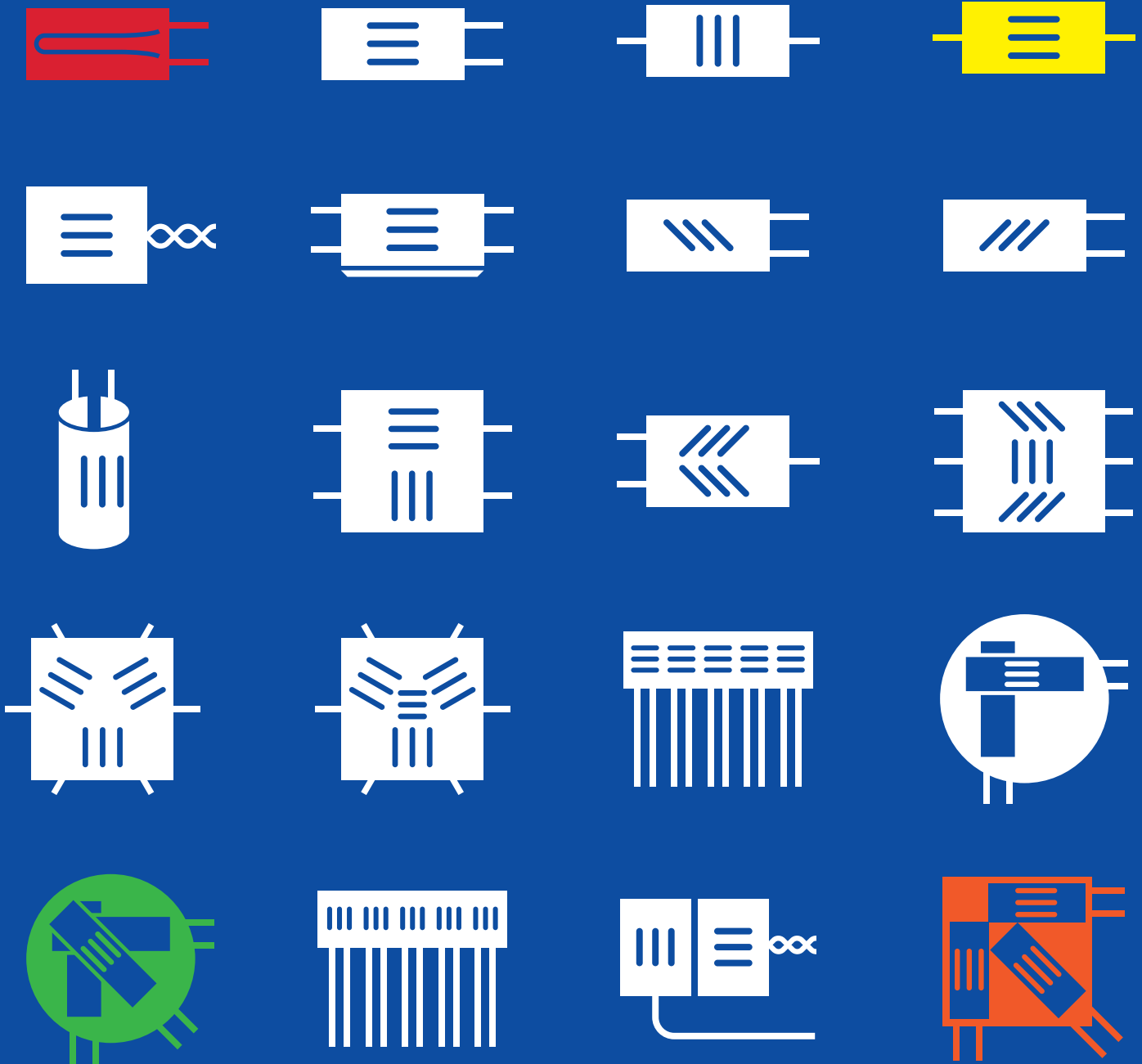

STRAIN GAGES



Wide range of applications and easy handling— essential factors for choosing Kyowa strain gages

Strain gages are designed to electrically detect “strain,” minute mechanical changes occurring in response to applied force. They are used not only for machines and moving objects but also in various fields including electrical equipment, civil engineering, building construction, chemicals and medicine. Strain gages enable detection of imperceptible elongations or shrinkages occurring in structures. Measurement of such elongations or shrinkages reveals the stress applied to the structure. Stress is an important factor to confirm the strength and safety of structures. Kyowa strain gages are available for measurement of varied types of strain, from static strain to dynamic strain occurring at higher than 100 kHz and impact-initiated strain. Kyowa strain gages also provide a wide range of applications and can conveniently be applied to structures of varied materials and shapes.

In addition, strain gages are used as sensing elements for measuring load, pressure, acceleration, displacement and torque. Thus, they are widely utilized not only in experiments and research but also for industrial measurement and control. Over 70 years ago Kyowa produced the first strain gage in Japan, and based on the abundant experience and technologies accumulated throughout these years, the company now manufactures various kinds of high-performance strain gages to cope with multiple application environments.

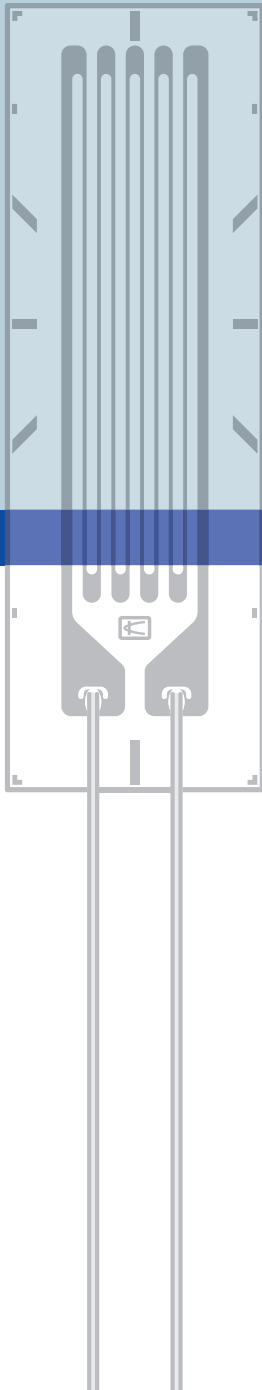

Fundamentals of Strain Gages

Metal changes its electrical resistance as it deforms. Strain gages take advantage of this property.

Generally, when metal deforms due to external force, its specific electrical resistance changes. The amount of electrical resistance is in inverse proportion to the cross-sectional area and is proportional to the length. If a metal wire is pulled, the cross-section becomes smaller and the length becomes longer, thereby making the resistance higher. If the wire is compressed, the resistance becomes lower. Elongation or shrinkage proportionally changes the electrical resistance of metal at a certain constant. By bonding the metal to the target structure, change in the electrical resistance of the metal is measured, thereby enabling detection of elongation or shrinkage, i.e. “strain” on the structure. The strain gage has fine wires or foil of such metal fixed onto an insulator base of resin, etc.

Resistance changes of strain gages bonded to the target object are extracted and amplified for stress measurement.

To obtain the internal stress of a structure, the external force-initiated minute elongation or shrinkage (strain) on the surface of the target object is measured. The measured strain is multiplied by Young’s modulus to obtain the stress. For that purpose, the strain gage must elongate or shrink in tandem with the measuring object under testing, and thus it should be securely bonded using the dedicated adhesive. The resistance of a strain gage changes by one-millionths. For precise measurement of such resistance change, a bridge circuit is formed to convert the resistance change to voltage change. Usually, however, since the voltage is at a μV level, it is amplified by 5000 to 10000 times to be readable on analog and digital indicators.

Electrically amplified voltage changes are read out on a measuring instrument. Measured values are recorded and analyzed for multiple purposes.

The dedicated indicator enables direct reading of amplified voltages as strain quantity. Kyowa strain amplifiers have their amplifier circuitry and digital indicator incorporated into one package. It is difficult to read moving dynamic strain on indicators. Therefore, a recorder is usually used to obtain ever-changing strain quantity. In addition to conventional chart recorders, magnetic tape recorders and data loggers, Kyowa now has on the market a sensor interface which enables a PC to directly receive data from strain gages via a bridge box, as well as a memory recorder/analyzer equipped with high-speed AD converter and large-capacity memory for storage and analysis of dynamic strain data.

CONTENTS

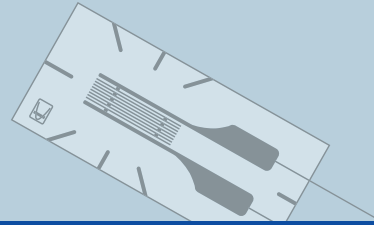

■ Strain Gage Model Name Coding System	4
■ Principles of Strain Gages	6
■ Static Strain and Dynamic Strain	16
■ Uses of Strain Gages	17
■ Selecting Strain Gages	18
● 1. Selecting a strain gage based on operating temperatures and other measuring conditions ...	19
● 2. Selecting a strain gage based on operating environment and purpose	20
● 3. Selecting the type and the length of a lead-wire cable for the gage selected in 1 or 2	22
● 4. Selecting a lead-wire cable based on operating temperature range and connection examples ...	24
● 5. Adhesives and bonding tools	
Adhesives	26
Gage Bonding Tool Kit	28
Gage Presser	28
Compact Spot Welder	29
● 6. Gage terminals and other accessories	
Gage Terminals	30
Coating Agents	31
Accessories for High-temperature Gages	31
■ Strain Gages	
● Gages for General Stress Measurement	
KFGS General-purpose Foil Strain Gages	32
KFGS Foil Strain Gages with Gage Terminal	43
KFGS Foil Strain Gages for Boring Method	44
KFB Strain Gages for Measuring Axial Tension of Bolt	45
KFGT Foil Strain Gages with a Temperature Sensor	46
KFRB Foil Strain Gages	47
● Waterproof Strain Gages	
KFWB Waterproof Foil Strain Gages	51
KFWS Small-sized Waterproof Foil Strain Gages	53
KCW Weldable Waterproof Foil Strain Gages	54
● Strain Gages for Concrete	
KFGS General-purpose Foil Strain Gages	55
KC Wire Strain Gages	56
KM Embedded Strain Gages	57
KMC Concrete-embedded Strain Gages	58



- **Strain Gages for Composite Materials and Plastics**
 - KFRPB Foil Strain Gages for Composite Materials 59
 - KFRS Foil Strain Gages for Printed Boards 61
 - KFP Foil Strain Gages for Plastics 63
- **Strain Gages for Ultra-small Strain Measurements**
 - KSPB Semiconductor Strain Gages 64
 - KSNB Self-temperature-compensation Semiconductor Strain Gages 65
 - KSPH High-output Semiconductor Strain Gages 66
 - KSPLB Ultra Linear Semiconductor Strain Gage 67
- **High-temperature Gages**
 - KFU High-temperature Foil Strain Gages 68
 - KH High-temperature Foil Strain Gages 70
 - KFHB High-temperature Foil Strain Gages 71
- **Low-temperature Gages**
 - KFLB Low-temperature Foil Strain Gages 74
- **High-elongation Strain Gages**
 - KFEM Ultrahigh-elongation Foil Strain Gages 77
 - KFEL High-elongation Foil Strain Gages 78
- **Non-magneto-resistive Gages**
 - KFNB Non-inductive Foil Strain Gages 79
 - KFSB Shielded Foil Strain Gages 80
- **Gages for Hydrogen Gas Environment**
 - KFV Foil Strain Gage for Hydrogen Gas Environment 81
- **Bending Strain Measuring Gages**
 - KFF Foil Strain Gages for Bending Strain Measurement 82
- **Gages with a Protector**
 - KCH Foil Strain Gages with a Protector 83
- **Embedded Gages**
 - KMP Embedded Gage 84
- **Special Gages**
 - KV Crack Gages 85
- **Encapsulated Gages** 86
- **Custom-designed Gages** 87

Note:

Concentrations of the 6 restricted substances designated in RoHS Directive are less than the maximum allowable (Excluding exceptions for applying usage prohibition measures).

Concentrations of the 10 restricted substances designated in ANNEXII of RoHS Directive are less than the maximum allowable (Excluding exceptions for applying usage prohibition measures).

Strain Gage Model Name Coding System

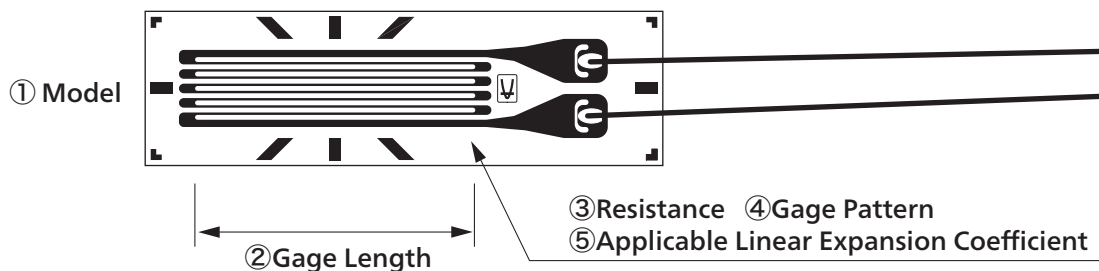

KFGS - 2 - 120 - C1 -

① Model

KFGS: General-purpose Foil Strain Gages
 KFB: Strain Gages for Measuring Axial Tension of Bolt
 KFGT: Foil Strain Gages with a Temperature Sensor
 KFRB: Foil Strain Gages
 KFWB: Waterproof Foil Strain Gages
 KFWS: Small-sized Waterproof Foil Strain Gages
 KCW: Weldable Waterproof Foil Strain Gages
 KC: Wire Strain Gages
 KM: Embedded Strain Gages
 KMC: Concrete-embedded Strain Gages
 KFRPB: Foil Strain Gages for Composite Materials
 KFRS: Foil Strain Gages for Printed Boards
 KFP: Foil Strain Gages for Plastics
 KSPB: Semiconductor Strain Gages
 KSNB: Self-temperature-compensation Semiconductor Strain Gages
 KSPH: High-output Semiconductor Strain Gages
 KSPLB: Ultra Linear Semiconductor Strain Gages
 KHXC: Encapsulated Gages
 KHCR: Encapsulated Gages
 KHCV: Encapsulated Gages
 KHCS: Encapsulated Gages
 KHCM: Encapsulated Gages
 KHC: Encapsulated Gages
 KFV: High-temperature Foil Strain Gages
 KH: High-temperature Foil Strain Gages
 KFHB: High-temperature Foil Strain Gages
 KFLB: Low-temperature Foil Strain Gages
 KFEM: Ultrahigh-elongation Foil Strain Gages
 KFEL: High-elongation Foil Strain Gages
 KFNB: Non-inductive Foil Strain Gages
 KFSB: Shielded Foil Strain Gages
 KFV: Foil Strain Gage for Hydrogen Gas Environment
 KFF: Foil Strain Gages for Bending Strain Measurement
 KCH: Foil Strain Gages with a Protector
 KMP: Embedded Gage
 KV: Crack Gages

② Gage Length

015: 0.15 mm
 02N: 0.2 mm
 02: 0.2 mm
 03: 0.3 mm
 05: 0.5 mm
 1N: 1 mm
 1: 1 mm
 1.5: 1.5 mm
 2N: 2 mm
 2: 2 mm
 3: 3 mm
 4N: 4 mm
 4: 4 mm
 5: 5 mm
 6: 6 mm
 7: 7 mm
 9: 9 mm
 10: 10 mm
 20: 20 mm
 30: 30 mm
 60: 60 mm
 70: 70 mm
 80: 80 mm
 120: 120 mm

*Suffix N indicates base and grid widths are narrow.

③ Resistance

60: 60 Ω
 120: 120 Ω
 350: 350 Ω
 500: 500 Ω
 1K: 1000 Ω
 2K: 2000 Ω
 10K: 10000 Ω

④ Gage Pattern

A1: Uniaxial, leads at one end (KC gage)
 C1: Uniaxial, leads at one end (Foil gage)
 C2: Uniaxial 90°, leads at both ends
 C3: Uniaxial 0°, leads at both ends
 C9: Uniaxial, leads at one end (KFNB gage)
 C11: Uniaxial, 2-element, 1 mm thick (KFF gage)
 C12: Uniaxial, 2-element, 2 mm thick (KFF gage)
 C15: Uniaxial right 45°, for shearing strain, leads at one end
 C16: Uniaxial left 45°, for shearing strain, leads at one end
 C20: Uniaxial, leads at one end (KFB gage)
 D1: Biaxial 0/90°, leads at both ends
 D2: Biaxial 0/90°, leads at both ends (For torque)
 D3: Triaxial 0/45/90°, leads at both ends, plane arrangement
 D4: Triaxial 0/120/240°, plane arrangement
 D6: Quadraaxial 0/30/90/150°, plane arrangement
 D9: Uniaxial 5-element 90°
 D16: Biaxial 0/90° stacked rosette, round base
 D17: Triaxial 0/45/90° stacked rosette, round base
 D19: Uniaxial 5-element 0°
 D20: Biaxial 0/90° (KFNB gage)
 D22: Triaxial 0/45/90°, plane arrangement
 D25: Triaxial 0/45/90°, plane arrangement
 D28: Triaxial 0/90/135°, plane arrangement (For boring)
 D31: Biaxial 0/90°, leads at one end (For torque)
 D34: Biaxial 0/90°, plane arrangement
 D35: Triaxial 0/45/90°, plane arrangement
 D39: Biaxial 5-element 0/90°, stacked rosette
 E3: Uniaxial, leads at both ends (Semiconductor gage)
 E4: Uniaxial, leads at one end (Semiconductor gage)
 E5: Uniaxial, leads at both ends with no base (Semiconductor gage)
 F2: Uniaxial 2-element (Semiconductor gage)
 F3: Biaxial 0/90° (Semiconductor gage)
 G4: Uniaxial, leads at one end (KH-G4)
 G8: Uniaxial active-dummy 2-element, NCF (For KHC)
 G9: Uniaxial active-dummy 2-element, SUS (For KHC)
 G10: Uniaxial (For KCW)
 G12B: Uniaxial active-dummy 2-element (For KHCS)
 G13: Uniaxial active-dummy 2-element (For KHXC)
 G15: Uniaxial active-dummy 2-element (For KHCM)
 G16: Uniaxial active-dummy 2-element (For KHCR)
 G17: Uniaxial active 1-element (For KHCV)
 H1: Uniaxial (For KM-30)
 H2: Uniaxial (For KM-120)
 H3: Uniaxial (For KMC)
 H4: Uniaxial with T thermocouple (For KMC)
 J1: Uniaxial (For KFSB)

To select the most suitable strain gages and related products, refer to page 18 and onward.

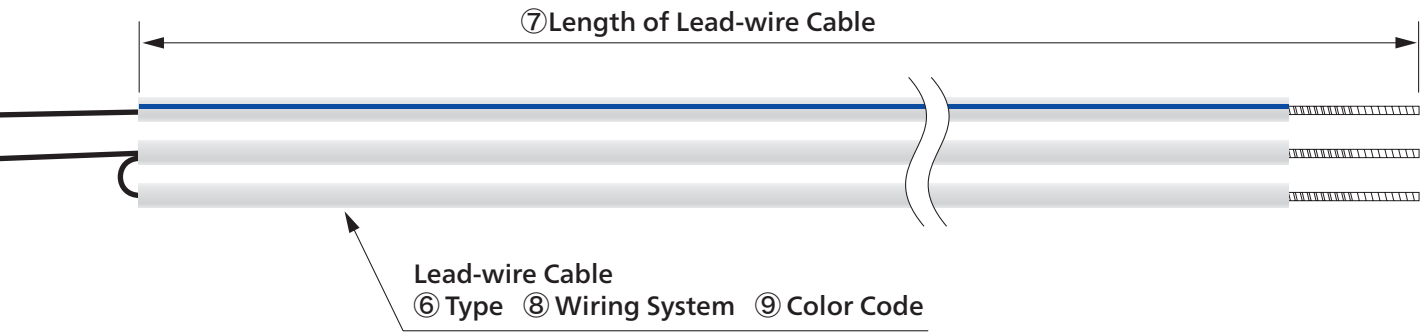

Lead-wire Cable

11

⑤ Applicable Linear Expansion Coefficient

- $(\times 10^{-6}/^{\circ}\text{C})$
- 1: Composite materials such as CFRP Amber (1.1) Diamond (1.2)
 - 3: Composite materials such as GFRP Silicon (2.3) Sulfur (2.7)
 - 5: Composite materials such as GFRP Tungsten (4.5) Lumber [Wood] (5.0) Molybdenum (5.2) Zirconium (5.4) Kovar (5.9)
 - 6: Composite materials such as GFRP 28 Tantalum (6.6)
 - 9: Composite materials such as CFRP, GFRP Titanium alloy (8.5) Platinum (8.9) Soda-lime glass (9.2)
 - 11: Common steel (11.7) SUS631 (10.3) SUS630 (10.6) Cast iron (10.8) Nickel-molybdenum steel (11.3) Beryllium (11.5)
 - 13: Corrosion and heat-resistant alloys such as NCF Nickel (13.3) Printed circuit board (13.0)
 - 16: Stainless steel SUS304 (16.2) Beryllium steel (16.7) Copper (16.7)
 - 23: A2014-T4 (23.4) Brass (21.0) Tin (23.0) A2024-T4 (23.2)
 - 27: Magnesium alloy (27.0)
 - 65: Acrylic resin (65.0) Polycarbonate (66.6)

L

⑥ Type

- C: MI cable (for KHC, KHCX, KHCR, KHCS, KHCM and KHCV gages)
- D: Glass-coated cable of 3 Ni-clad copper wires
- F: Fluoroplastic-coated high/low temperature 3-wire cable (equiv. to L-3 lead-wire cable)
- G: Chloroprene-coated 3-wire cable
- H: High/low temperature 3-wire cable (equiv. to L-17 lead-wire cable)
- J: Vinyl-coated normal temperature low-noise 3-wire cable (equiv. to L-13 lead-wire cable)
- L: Vinyl-coated flat 2 or 3-wire cable (L-6, L-7, L-9 or L-10)
- N: Polyester-coated copper wires
- R: Mid-temperature 2 or 3-wire cable (L-11 or L-12)
- W: Vinyl-coated flat 3-wire cable (for KM-120)
- Y: Vinyl-coated flat 2-wire cable (for KM-30)

1M

⑦ Length

- C: Centimeter
E.g. 30C = 30 cm
- M: Meter
E.g. 3M = 3 m

3

⑧ Wiring System

- 2: 2-wire system
 - 3: 3-wire system
- In the case of encapsulated gage
- Number: Length of soft cable
 - V: With bridge adapter
 - F: With compression fitting
 - FV: With both bridge adapter and compression fitting

R

⑨ Color Code

- Color codes for lead-wire cables are available only for vinyl-coated flat cables.
- 2-wire system (Vinyl-coated flat cables)
- R: Red
 - W: White*
 - B: Black*
 - G: Green*
 - Y: Yellow*
- *Custom-made
- S: Multi-axial gages (Standard)
- Biaxial (D16)
 - 0° (1st axis): Red
 - 90° (2nd axis): White
 - Triaxial (D17)
 - 0° (1st axis): Red
 - 45° (3rd axis): Green
 - 90° (2nd axis): White
- 3-wire system (Vinyl-coated flat cables)
- The insulator color is white and the stripe color code is as follows.
- R: Red
 - L: Blue*
 - B: Black*
 - G: Green*
 - Y: Yellow*
- *Custom-made
- S: Multi-axial gages (Standard)
- Biaxial (D16)
 - 0° (1st axis): Red
 - 90° (2nd axis): Yellow
 - Triaxial (D17)
 - 0° (1st axis): Red
 - 45° (3rd axis): Blue
 - 90° (2nd axis): Yellow

Note: Combination of codes is limited and menu options cannot freely be selected.

Principles of Strain Gages

Strain, Stress, and Poisson's Ratio

When tensile force P is applied to a material, it has stress σ that corresponds to the applied force. In proportion to the stress, the cross section contracts and the length elongates by ΔL from the length L the material had before receiving the tensile force. (See the upper illustration in Fig. 1.)

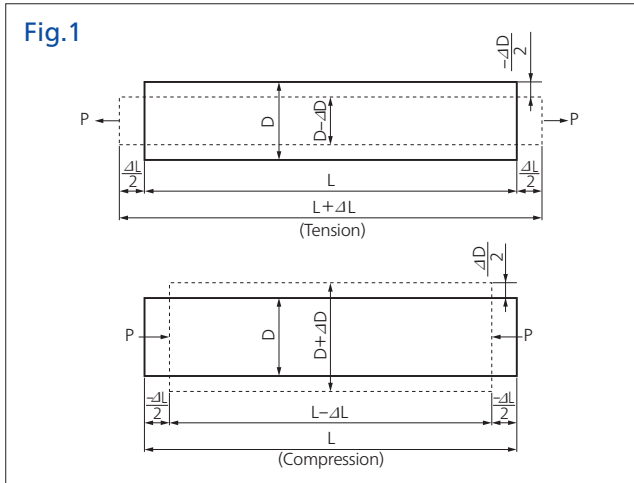

The ratio of the elongation to the original length is called a tensile strain and is expressed as follows:

$$\epsilon = \frac{\Delta L}{L}$$

ϵ : Strain
 L : Original length
 ΔL : Elongation

See the lower illustration in Fig. 1. If the material receives compressive force, it bears compressive strain expressed as follows:

$$\epsilon = -\frac{\Delta L}{L}$$

For example, if a tensile force makes 100 mm long material elongate by 0.01 mm, the strain initiated in the material is as follows:

$$\epsilon = \frac{\Delta L}{L} = \frac{0.01}{100} = 0.0001 = 100 \mu\text{m/m}$$

Thus, strain is an absolute number and is expressed with a numeric value with $\times 10^{-6}$ strain, $\mu\epsilon$ or $\mu\text{m/m}$ suffixed. Based on Hooke's law, the relation between stress and the strain initiated in a material by the applied force is expressed as follows:

$$\sigma = E \cdot \epsilon$$

σ : Stress
 E : Young's modulus
 ϵ : Strain

Stress is thus obtained by multiplying strain by the Young's modulus. When a material receives tensile force P , it elongates in the axial direction while contracting in the transverse direction. Elongation in the axial direction is called longitudinal strain and contraction in the transverse direction, transverse strain. The absolute value of the ratio between the longitudinal strain and transverse strain is called Poisson's ratio, which is expressed as follows:

$$\nu = \left| \frac{\epsilon_2}{\epsilon_1} \right|$$

ν : Poisson's ratio

ϵ_1 : Longitudinal strain $\frac{\Delta L}{L}$ or $-\frac{\Delta L}{L}$ (See Fig. 1)

ϵ_2 : Transverse strain $-\frac{\Delta D}{D}$ or $\frac{\Delta D}{D}$ (See Fig. 1)

Poisson's ratio differs depending on the material. For major industrial materials and their mechanical properties including Poisson's ratio, see the following table.

Mechanical Properties of Industrial Materials

$$G = \frac{E}{2(1+\nu)}$$

Material	Young's Modulus E (GPa)	Shearing Modulus G (GPa)	Tensile Strength (MPa)	Poisson's Ratio ν
Carbon steel (C0.1 to 0.25%)	205	78	363 to 441	0.28 to 0.3
Carbon steel (C > 0.25%)	206	79	471 to 569	0.28 to 0.3
Spring steel (Quenched)	206 to 211	79 to 81	588 to 1667	0.28 to 0.3
Nickel steel	205	78	549 to 657	0.28 to 0.3
Cast iron	98	40	118 to 235	0.2 to 0.29
Brass (Casting)	78	29	147	0.34
Phosphor bronze	118	43	431	0.38
Aluminum	73	27	186 to 500	0.34
Concrete	20 to 29	9 to 13	-	Approx. 0.2

Principles of Strain Gages

If external tensile force or compressive force increases or decreases, the resistance proportionally increases or decreases. Suppose that original resistance R changes by ΔR because of strain ϵ : the following equation is set up.

$$\frac{\Delta R}{R} = K_s \cdot \frac{\Delta L}{L} = K_s \cdot \epsilon$$

Where, K_s is a gage factor, expressing the sensitivity coefficient of strain gages. General-purpose strain gages use copper-nickel or nickel-chrome alloy for the resistive elements, and the gage factor provided by these alloys is approximately 2.

Types of Strain Gages

Types of strain gages are classified into foil strain gages, wire strain gages, and semiconductor strain gages, etc.

Structure of a Strain Gage

A strain gage has a grid-shaped metallic foil photo-etched onto the base material (thin resin or similar electric insulator), to which gage leads are attached, as shown in Fig. 2 below.

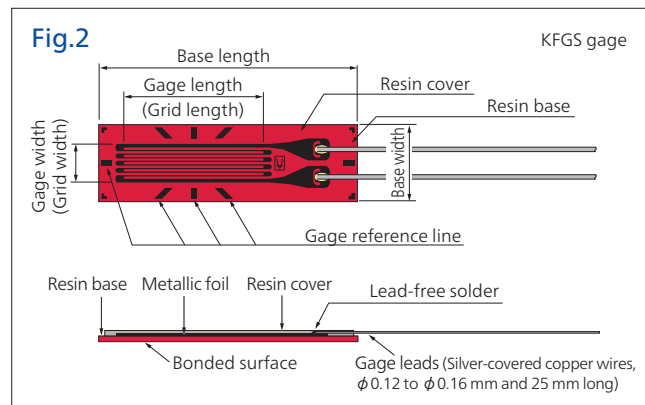

The strain gage is bonded to the measuring object with a dedicated adhesive. Strain occurring on the measuring site is transferred to the strain sensing element via adhesive and the resin base. For accurate measurement, the strain gage and adhesive should be compatible with the measuring material and operating conditions such as temperature, etc. Refer to page 13, "Strain Gage Bonding Procedure" for details on bonding strain gages to metallic objects.

Principles of Strain Measurement

Strain-initiated resistance change is extremely small. Thus, for strain measurement a Wheatstone bridge is formed to convert the resistance change to a voltage change. Suppose in Fig. 3 resistances (Ω) are R_1 , R_2 , R_3 and R_4 and the excitation voltage (V) is E . Then, the output voltage e_0 (V) is obtained by the following equation:

$$e_0 = \frac{R_1 R_3 - R_2 R_4}{(R_1 + R_2)(R_3 + R_4)} \cdot E$$

Suppose the resistance R_1 is a strain gage and it changes by ΔR due to strain. Then, the output voltage is,

$$e_0 = \frac{(R_1 + \Delta R) R_3 - R_2 R_4}{(R_1 + \Delta R + R_2)(R_3 + R_4)} \cdot E$$

If $R_1 = R_2 = R_3 = R_4 = R$ in the initial condition,

$$e_0 = \frac{R^2 + R \Delta R - R^2}{(2R + \Delta R) 2R} \cdot E$$

Since R may be regarded extremely larger than ΔR ,

$$e_0 \approx \frac{1}{4} \cdot \frac{\Delta R}{R} \cdot E = \frac{1}{4} \cdot K_s \cdot \varepsilon \cdot E$$

Thus, obtained is an output voltage that is proportional to a change in resistance, i.e. a change in strain. This microscopic output voltage is amplified for analog recording or digital indication for strain measurement.

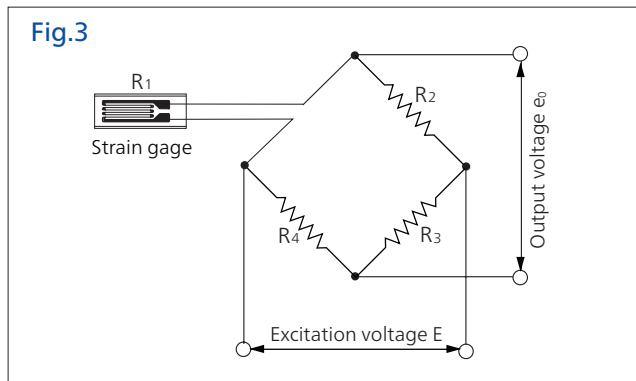

Strain Gage Wiring System

A strain gage Wheatstone bridge is configured with a quarter, half, or full bridge according to the measuring purpose. The typical wiring systems are shown in Figs. 4, 5 and 6. For various strain gage bridge systems, see pages 14 and 15.

● Quarter-bridge system (1-gage system)

With the quarter-bridge system, a strain gage is connected to one leg of the bridge and a fixed resistor is connected to each of the other 3 legs. This system will be easily configured, and thus it is widely used for general stress or strain measurement. The quarter-bridge 2-wire system shown in Fig. 4-1 is largely affected by leads. Therefore, if a big temperature change is expected or if the lead-wire length is long, then the quarter-bridge 3-wire system shown in Fig. 4-2 must be used. For the quarter-bridge 3-wire system, See "Compensation Methods of Temperature Effect of Lead Wires" (Page 10).

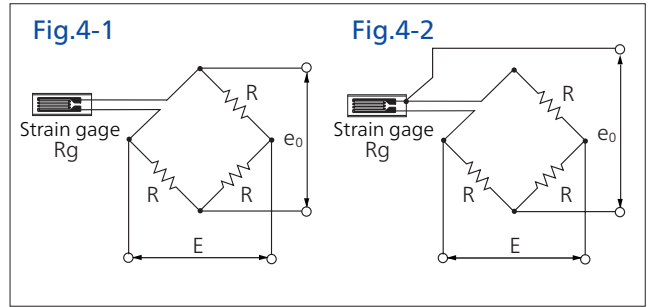

● Half-bridge system (2-gage system)

With the half-bridge system, 2 strain gages are connected to the bridge, one each to adjacent or opposite legs with fixed resistors inserted in the other legs. See Figs. 5-1 and 5-2. There is the active-dummy system, where one strain gage serves as a dummy gage for temperature compensation, and the active-active system, where both gages serve as active gages. The half-bridge system is used to eliminate strain components other than the target strain; according to the measuring purpose, 2 gages are connected to the bridge in different ways. For details, see "How to Form Strain-gage Bridge Circuits" (Pages 14 and 15).

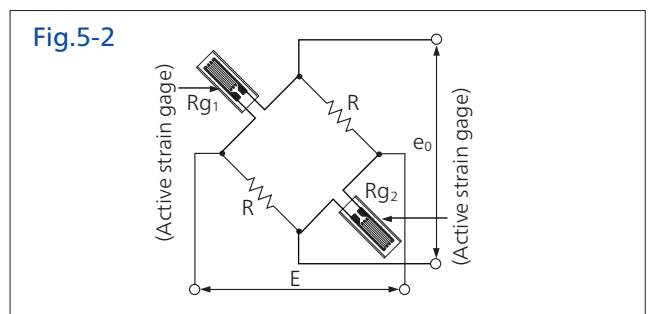
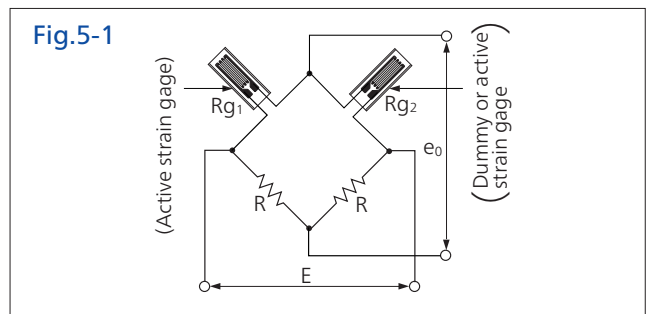

● Full-bridge system (4-gage system)

See Fig. 6. The full-bridge system has 4 strain gages connected one each to all 4 legs of the bridge. This circuit ensures large output of strain-gage transducers, improves temperature compensation and eliminates strain components other than the target strain. For details, see "How to Form Strain-gage Bridge Circuits" (Pages 14 and 15).

Fig.6

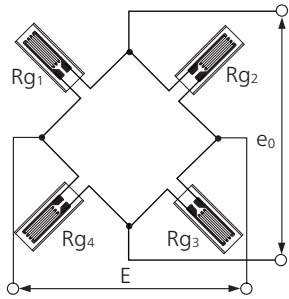

Equation of Strain on Beams

Strain ϵ_0 on the beam is obtained by the following equation :

$$\epsilon_0 = \frac{M}{ZE}$$

where, M: Bending moment (See Table 1)

Z: Section modulus (See Table 2)

E: Young's modulus (See table "Mechanical Properties of Industrial Materials," on page 6)

Typical shapes of beams, their bending moments M and section modulus Z are shown in Tables 1 and 2.

Bending Stress Measurement

(1) Quarter-bridge System

See the figure below. If a strain gage is bonded on the surface of a rectangular section of a cantilever of which one side end is fixed and load W is applied to another side, the surface stress σ which the bonded strain gage will detect is as follows:

$$\sigma = \epsilon_0 \cdot E$$

Strain ϵ_0 is obtained by the following equation:

$$\epsilon_0 = \frac{6WL}{Ebh^2}$$

where, b: Width of the cantilever

h: Thickness of the cantilever

L: Distance from the load point to the center of strain gage

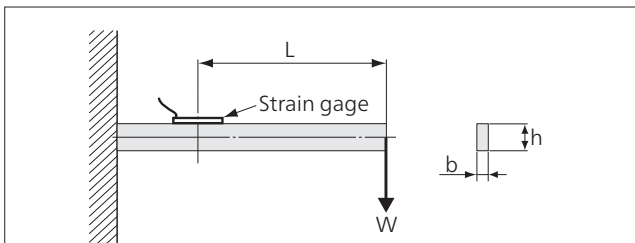

Bending Stress Measurement (with Quarter-bridge System)

(2) Half-bridge System (Adjacent-leg Bridge Connection)

As illustrated below, strain gages bonded symmetrically on the front and rear surfaces of the cantilever output positive and negative signals, respectively, with an equal absolute value. If these 2 gages are connected to adjacent legs of the bridge, the output of the bridge corresponding to the bending strain is doubled and the surface stress σ at the strain-gage bonding site is obtained by the following equation:

$$\sigma = \frac{\epsilon_0}{2} \cdot E$$

The adjacent-leg active half-bridge system cancels out the output of the strain gage corresponding to the force applied in the axial direction of the cantilever.

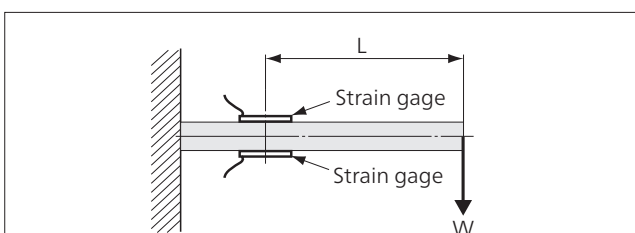

Bending Stress Measurement (with Half-bridge System)

Table 1. Typical Equations to Calculate Bending Moment

Shape of Beam	Bending Moment M
	$M = WL$
	$0 \leq L \leq \frac{l}{2} \rightarrow M = \frac{WL}{2} \left(\frac{1}{4} - \frac{L}{l} \right)$ $L = 0 \quad L = \frac{l}{2} \rightarrow M = \pm \frac{Wl}{8}$ $\frac{l}{2} \leq L \leq l \rightarrow M = \frac{WL}{2} \left(\frac{1}{l} - \frac{3}{4} \right)$
	$0 \leq L \leq \frac{l}{2} \rightarrow M = -\frac{WL}{2}$ $L = \frac{l}{2} \rightarrow M = -\frac{Wl}{4}$ $\frac{l}{2} \leq L \leq l \rightarrow M = -\frac{W(l-L)}{2}$
	$0 \leq L \leq l_1 \rightarrow M = WL$ $l_1 \leq L \leq (l_1 + l_2) \rightarrow M = Wl_1$

Table 2. Typical Equations to Calculate Section Modulus

Cross Section	Section Modulus Z
	$\frac{1}{6} bh^2$
	$\frac{1}{6} \cdot \frac{b (h_2^3 - h_1^3)}{h_2}$
	$\frac{\pi}{32} d^3$
	$\frac{\pi}{32} \cdot \frac{d_2^4 - d_1^4}{d_2}$

Torsional and Shearing Stress Measurement of Axis

When an object is twisted, shearing stress τ occurs. At the same time, tensile stress and compressive stress, which are equivalent to the shearing stress, occur in 2 directions inclined by 45° from the axial line.

In measurement of axial twist under simple shearing stress condition, a strain gage does not directly measure the shearing stress. Instead, a strain gage detects tensile or compressive strain resulting from tensile or compressive stress simultaneously generated with the shearing stress. These stress conditions on a surface of axis are illustrated below.

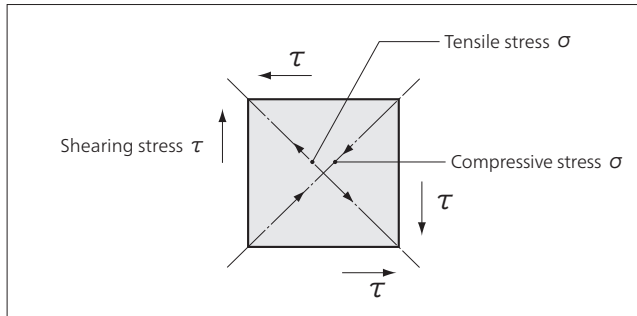

Shearing strain γ is defined as illustrated below, and the magnitude is calculated by the following equation:

$$\gamma = \frac{\tau}{G}$$

where, G : Shearing modulus (See table "Mechanical Properties of Industrial Materials," on page 6)
 τ : Shearing stress

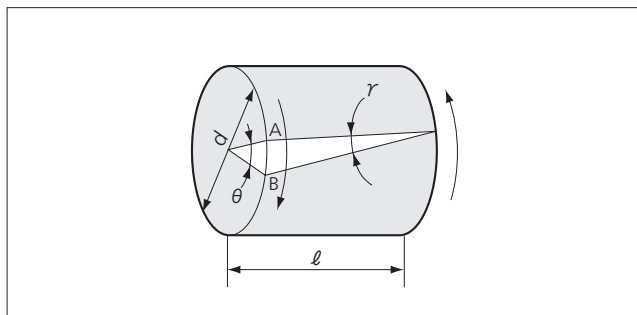

When the axis is twisted, point A moves to point B, thereby initiating torsional angle θ .

$$\theta = \frac{l r}{\left(\frac{d}{2}\right)} = \frac{2 l r}{d}$$

(1) Stress Measurement with Quarter-bridge System

Bond the strain gage on the twisted axis in the direction inclined by 45° from the axial line. The relations between strain ϵ_0 and stress σ are expressed with the following equation to calculate tensile or compressive stress σ :

$$\sigma = \frac{\epsilon_0 \cdot E}{1 + \nu}$$

where, ϵ_0 : Indicated strain
 E : Young's modulus (See table "Mechanical Properties of Industrial Materials," on page 6)
 ν : Poisson's ratio

Stress σ and shearing stress τ are equal in magnitude, and thus,
 $\tau = \sigma$

(2) Stress Measurement with Half-bridge or Full-bridge System
 Half-bridge or full-bridge systems increase strain output by 2 (half-bridge system) or 4 times (full-bridge system), because each strain gage in the half-bridge or full-bridge system detects equal strain. To calculate true strain, divide measured strain by 2 (half-bridge system) or 4 (full-bridge system).

(3) Application to Torque Measurement

Strain on the surface of the axis is proportional to the torque applied to the axis. Thus, the torque is obtained by detecting the strain on the surface.

Shearing stress distributed on the lateral section is balanced with the applied torque T , establishing the following equation:

$$T = \tau \cdot Z_p$$

where, Z_p : Polar modulus of section

Converting shearing stress in the above equation to tensile strain produces an equation as follows:

$$T = \frac{\epsilon_0 \cdot E \cdot Z_p}{1 + \nu}$$

The polar modulus of the section is specific to each shape of the cross-section as follows:

Cross Section	Polar Modulus of Section Z_p
	$\frac{\pi d^3}{16}$
	$\frac{\pi}{16} \left(\frac{d_2^4 - d_1^4}{d_2} \right)$

A strain gage torque transducer is designed using the above relational expression of ϵ_0 and T . Obtain ϵ_0 from the allowable stress for the material, and determine the width d of the axis which is matched with the magnitude of the applied torque. Then, amplify the strain output with a strain amplifier and read the output voltage with a measuring instrument.

Principles of Self-temperature-compensation Gages (SELCOM Gages)

The measuring object and the resistive element of the strain gage have linear expansion coefficients β_s and β_g , respectively. The strain gage bonded on the surface of the object provides a thermally-induced apparent strain ϵ_T per $^{\circ}\text{C}$ that is expressed with the following equation:

$$\epsilon_T = \frac{\alpha}{Ks} + (\beta_s - \beta_g)$$

where,

- α : Resistive temperature coefficient of resistive element
- Ks : Gage factor of strain gage

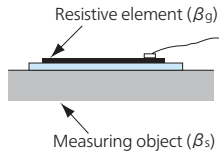

Self-temperature-compensation strain gages are designed to adjust the resistive temperature coefficient of their resistive elements to match the linear expansion coefficient of the measuring objects in order to get ϵ_T close to zero. Kyowa's SELCOM gages have been adjusted so that, when they are bonded to suitable measured materials, the average value of the apparent strain in the self-temperature-compensation range is within $\pm 1.8 \mu\text{m/m per }^{\circ}\text{C}$ (representative value). (Graph below shows apparent strain output of strain gages without lead wires.)

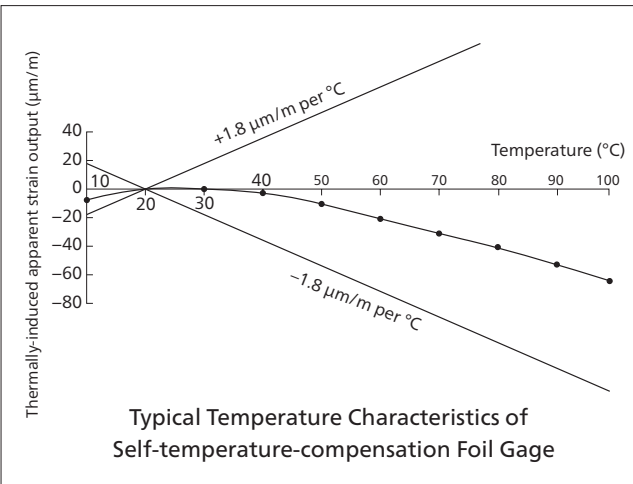

Linear Expansion Coefficients of Materials ($\times 10^{-6}/^{\circ}\text{C}$)

Material	Linear Exp. Coef.	Material	Linear Exp. Coef.
Quartz glass	0.4	Beryllium	11.5
Amber	1.1	Common steel	11.7
Brick	3.0 to 5.0	Nickel	13.3
Tungsten	4.5	Gold	14.0
Lumber (Grain dir.)	5.0	SUS 304	16.2
Molybdenum	5.2	Beryllium copper	16.7
Zirconium	5.4	Copper	16.7
Kovar	5.9	Brass	21.0
Concrete	6.8 to 12.7	A2024-T4	23.2
Titanium alloy	8.5	A2014-T4	23.4
Platinum	8.9	Magnesium alloy	27.0
Soda-lime glass	9.2	Lead	29.0
SUS 631	10.3	Acrylic resin	Approx. 65 to 100
SUS 630	10.6	Polycarbonate	66.6
Cast iron	10.8	Rubber	Approx. 77
NiCrMo steel	11.3		

Temperature Effect on Lead Wires with 2-wire System

Lead Wire Model	Cross-section Area of Conductor (mm ²)	Reciprocating Resistance of 1 m long lead wire (Ω)	Apparent Strain* with 1 m Extension ($\mu\text{m/m per }^{\circ}\text{C}$)
L-5	0.5	Approx. 0.07	Approx. 1.14
L-9	0.11	Approx. 0.32	Approx. 5.19
L-6	0.08	Approx. 0.44	Approx. 7.12
N (Polyester-coated copper cable)	0.015	Approx. 2.24	Approx. 35.7

*120 Ω gage

Thermally-induced apparent strain ϵ_r ($\mu\text{m/m per }^{\circ}\text{C}$) is calculated by the following equation.

$$\epsilon_r = \frac{r\ell}{R_g + r\ell} \cdot \frac{\alpha}{Ks}$$

- where, R_g : Resistance of strain gage (Ω)
- $r\ell$: Reciprocating resistance of lead wires (Ω)
- Ks : Preset gage factor of strain amplifier, usually 2.00
- α : Resistive temperature coefficient of copper wire ($\Delta R/R$ per $^{\circ}\text{C}$), $3.9 \times 10^{-3}/^{\circ}\text{C}$

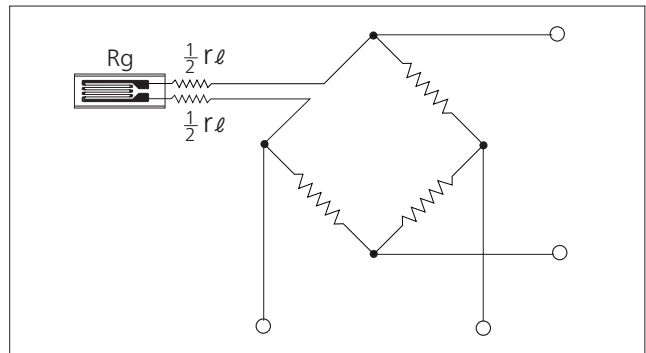

Compensation Methods of Temperature Effect of Lead Wires (3-wire System)

For effective self-temperature-compensation, SELCOM gages adopt the quarter-bridge system. However, if the lead wire cable is the 2-wire system, strain output from the bridge is affected by the temperature effect of the lead wire. To avoid such adverse effect, the 3-wire system is adopted. If 3 lead wires are connected to a strain gage as shown below, a half lead wire resistance is applied to the adjacent side of a bridge to compensate for the temperature effect of lead wires in bridge output. The temperature effect of the lead wires connected to a measuring instrument outside of the bridge is ignored because the input impedance of the measuring instrument is high.

As a precaution when using the 3-wire system, the 3 lead wires should be the same type, length, and cross-section to equalize temperature effects of each lead wire. If lead wires are directly exposed to sunlight, the coating color should also be the same.

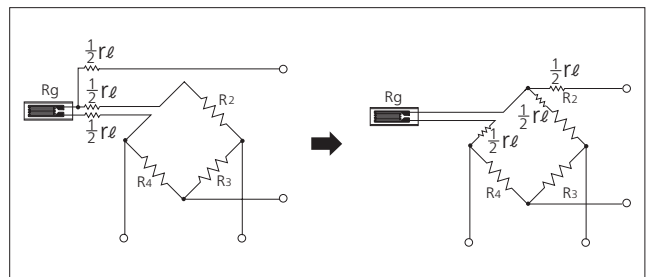

Influence of Insulation Resistance

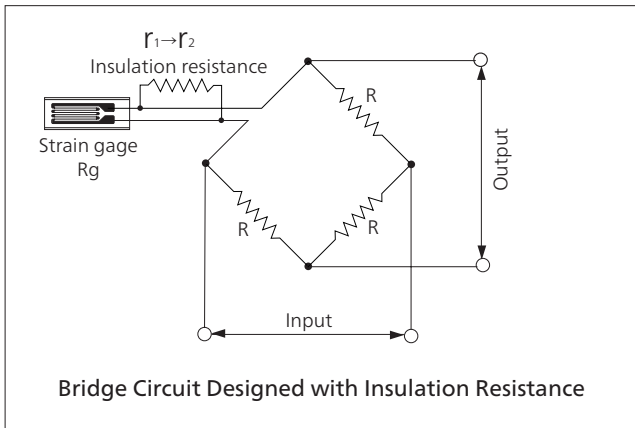

Bridge Circuit Designed with Insulation Resistance

If the insulation resistance descends from \$r_1\$ to \$r_2\$ in the figure

$$\text{Error strain}(\epsilon) \approx \frac{R_g(r_2 - r_1)}{K_s r_1 r_2}$$

- Rg: Resistance of strain gage
- Ks: Gage factor of strain gage
- r1: Original insulation resistance
- r2: Changed insulation resistance

Insulation resistances of strain gages including lead wires do not affect measured values if they are higher than 100 MΩ. However, if they change drastically during measurement, errors may occur in measured values.

Resistance Change of Strain Gages Bonded to Curved Surfaces

The strain \$\epsilon_c\$ occurring on the resistive element of a strain gage bonded to a curved surface may be expressed by the following equation:

$$\epsilon_c = \frac{t}{2r + t}$$

- where, t: Thickness of gage base plus adhesive layer
 - r: Curvature radius of gage-bonded surface
- For example, if a uniaxial KFGS gage, of which the gage base including the adhesive layer is 0.015 mm thick, is bonded to a curved surface of \$r=1.5\$ mm, the strain gage already receives strain of approximately 5000 \$\mu\text{m}/\text{m}\$.

If the gage factor \$K_s\$ is 2.00,

$$\Delta R/R \approx 10000 \times 10^{-6}$$

If the gage resistance is 120 \$\Omega\$, it increases by approximately 1.2 \$\Omega\$. If the gage is bonded inside the curve, the resistance decreases.

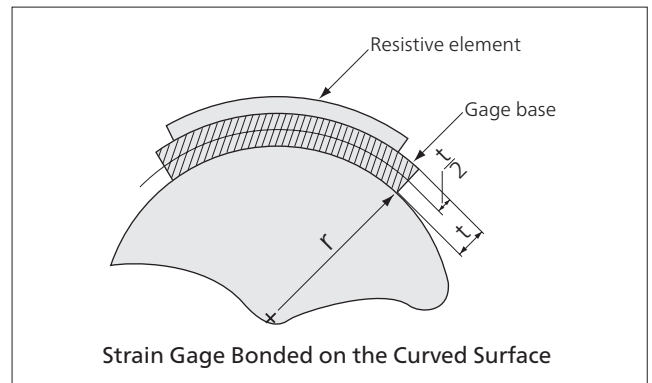

Strain Gage Bonded on the Curved Surface

Compensation Methods of Different Gage Factors

If the gage factor of the strain gage (2.00) is different from that of the strain amplifier, the true strain \$\epsilon\$ is obtained by the following equation:

$$\epsilon = \frac{2.00}{K_s} \times \epsilon_0$$

- where, \$\epsilon_0\$: Measured strain
- \$K_s\$: Gage factor of strain gage

Misalignment Effect of Bonding Strain Gages

Strain \$\epsilon_0\$ misaligned by angle \$\theta\$ from the direction of the principal strain \$\epsilon_1\$ is calculated by the following equation:

$$\epsilon_0 = \frac{1}{2} \{ (\epsilon_1 + \epsilon_2) + (\epsilon_1 - \epsilon_2) \cos 2\theta \}$$

If \$\epsilon_2 = -\nu \epsilon_1\$ (\$\nu\$: Poisson's ratio) under the uniaxial stress condition,

$$\epsilon_0 = \frac{1}{2} \epsilon_1 \{ (1 - \nu) + (1 + \nu) \cos 2\theta \}$$

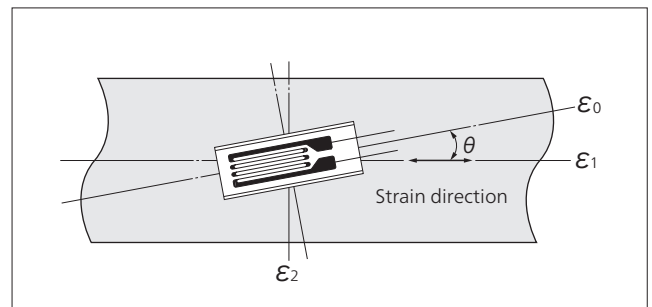

Compensation Methods of Effect of Lead Wire Extension

If the lead wire or cable is extended with the quarter-bridge or half-bridge system, additional resistance is initiated in series to the strain gage, thereby decreasing the apparent gage factor. For example, if a 10 m long lead wire with 0.3 mm\$^2\$ conductors is used, the gage factor decreases by 1%. In the case of the full-bridge system (transducer), the extension decreases the excitation voltage too. In these cases, the true strain \$\epsilon\$ is obtained by the following equation.

$$\epsilon = \left(1 + \frac{r\ell}{R_g} \right) \times \epsilon_i$$

- where, \$\epsilon_i\$: Measured strain
- \$R_g\$: Resistance of strain gage
- \$r\ell\$: Total resistance of lead wires (For reciprocating resistance, see the table on the following page.)
- One-way resistance in the case of 3-wire system

Lead wire resistance values

Cross Section (mm ²)	Number of Strands/Wire Diam. (mm)	Reciprocating Resistance per 10 m (Ω)	Remarks
0.08	7/φ0.12	4.4	L-6
0.11	10/φ0.12	3.2	L-9
0.3	12/φ0.18	1.2	L-2
0.5	20/φ0.18	0.7	L-5

● Compensation Methods of Nonlinearity Error of Quarter-bridge System

An error of nonlinearity in high-elongation strain measurement with quarter-bridge system is found by calculating true strain \mathcal{E} in the following equation:

$$\mathcal{E} = \frac{\mathcal{E}_0}{1 - \mathcal{E}_0}$$

where, \mathcal{E}_0 : Measured strain

● Methods of Obtaining Magnitude and Direction of Principal Stress (Rosette Analysis)

Generally, if the direction of principal stress is uncertain in structure stress measurement, a triaxial rosette gage is used and measured strain values are calculated in the following equation to find the direction of the principal stress. (The following equation is only for specified angle triaxial rosette gages.)

Precautions in Analysis

- Regard $\mathcal{E}_a \rightarrow \mathcal{E}_b \rightarrow \mathcal{E}_c$ as the forward direction.
- Angle θ is:
 - Angle of the maximum principal strain to the \mathcal{E}_a axis when $\mathcal{E}_a > \mathcal{E}_c$.
 - Angle of the minimum principal strain to the \mathcal{E}_a axis when $\mathcal{E}_a < \mathcal{E}_c$.
 - Comparison between \mathcal{E}_a and \mathcal{E}_c in magnitude includes plus and minus signs.

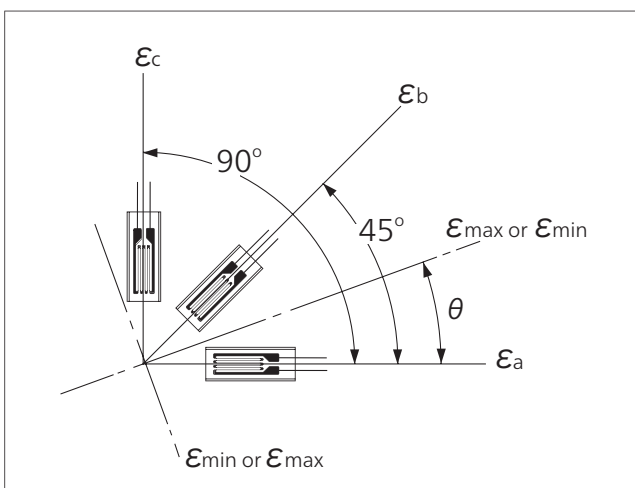

$$\text{Max. principal strain } \mathcal{E}_{\max} = \frac{1}{2} [\mathcal{E}_a + \mathcal{E}_c + \sqrt{2 \{ (\mathcal{E}_a - \mathcal{E}_b)^2 + (\mathcal{E}_b - \mathcal{E}_c)^2 \}}]$$

$$\text{Min. principal strain } \mathcal{E}_{\min} = \frac{1}{2} [\mathcal{E}_a + \mathcal{E}_c - \sqrt{2 \{ (\mathcal{E}_a - \mathcal{E}_b)^2 + (\mathcal{E}_b - \mathcal{E}_c)^2 \}}]$$

$$\text{Direction of principal strain (From } \mathcal{E}_a \text{ axis)} \quad \theta = \frac{1}{2} \tan^{-1} \left[\frac{2\mathcal{E}_b - \mathcal{E}_a - \mathcal{E}_c}{\mathcal{E}_a - \mathcal{E}_c} \right]$$

$$\text{Max. shearing strain } \gamma_{\max} = \sqrt{2 \{ (\mathcal{E}_a - \mathcal{E}_b)^2 + (\mathcal{E}_b - \mathcal{E}_c)^2 \}}$$

$$\text{Max. principal stress } \sigma_{\max} = \frac{E}{2(1-\nu^2)} \left[(1+\nu)(\mathcal{E}_a + \mathcal{E}_c) + (1-\nu) \times \sqrt{2 \{ (\mathcal{E}_a - \mathcal{E}_b)^2 + (\mathcal{E}_b - \mathcal{E}_c)^2 \}} \right]$$

$$\text{Min. principal stress } \sigma_{\min} = \frac{E}{2(1-\nu^2)} \left[(1+\nu)(\mathcal{E}_a + \mathcal{E}_c) - (1-\nu) \times \sqrt{2 \{ (\mathcal{E}_a - \mathcal{E}_b)^2 + (\mathcal{E}_b - \mathcal{E}_c)^2 \}} \right]$$

$$\text{Max. shearing stress } \tau_{\max} = \frac{E}{2(1+\nu)} \times \sqrt{2 \{ (\mathcal{E}_a - \mathcal{E}_b)^2 + (\mathcal{E}_b - \mathcal{E}_c)^2 \}}$$

ν : Poisson's ratio

E: Young's modulus

(See table "Mechanical Properties of Industrial Materials," on page 6.)

● Generating Calibration Values Based on the Tip Parallel Resistance Method

When extending lead wires by several hundred meters or finding accurate calibration values, the tip parallel resistance method is adopted. The parallel resistance R_c is calculated by the following equation:

$$R_c = \frac{R_g}{K_s \cdot \mathcal{E}} - R_g$$

where, R_g : Resistance of strain gage
 K_s : Gage factor of strain gage
 \mathcal{E} : Calibration strain value

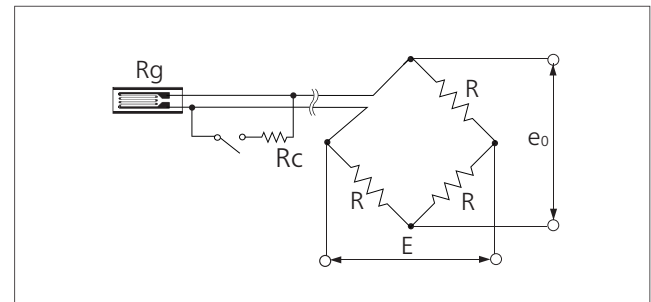

Examples of Calibration Strain Value and Resistance ($R_g = 120 \Omega$, $K_s = 2.00$)

(The strain value is output as a negative value.)

Calibration Strain Value \mathcal{E}	Resistance R_c
100 $\mu\text{m/m}$	Approx. 600k Ω
200 $\mu\text{m/m}$	Approx. 300k Ω
500 $\mu\text{m/m}$	Approx. 120k Ω
1000 $\mu\text{m/m}$	Approx. 60k Ω
2000 $\mu\text{m/m}$	Approx. 30k Ω

Strain Gage Bonding Procedure

The strain gage bonding method differs depending on the type of the strain gage, the applied adhesive and operating environment. Here, for strain measurement at normal temperatures in a room, we show how to bond a typical strain gage (Lead-wire-equipped KFGS gage) to a test piece (Mild steel specimen) using quick-curing adhesive (Cyanoacrylate adhesive CC-33A).

① Select strain gage.

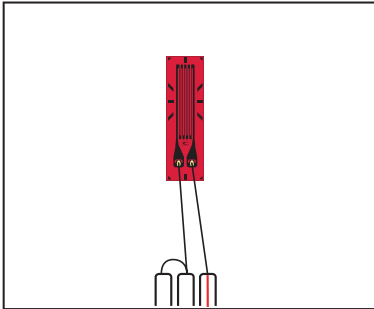

Select the strain gage model and gage length which meet the requirements of the measuring object and purpose. For the linear expansion coefficient of the gage applicable to the measuring object, refer to Linear Expansion Coefficients of Materials.

⑤ Apply adhesive.

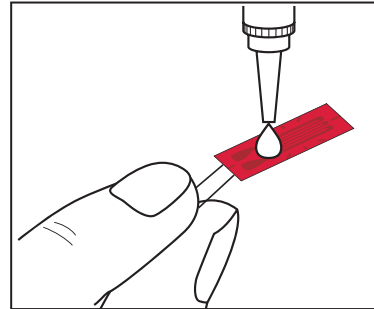

Ascertain the back and front of the strain gage. Apply a drop of adhesive (CC-33A) to the back of the strain gage.

② Remove rust and paint.

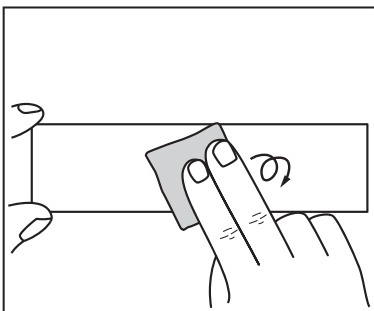

Using a sand cloth (#320), polish the strain-gage bonding site over a wider area than the strain gage size. Wipe off paint, rust and plating, if any, with a grinder or sandblast before polishing.

⑥ Bond strain gage.

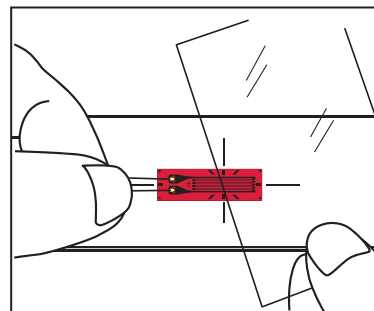

After applying a drop of the adhesive, put the strain gage on the measuring site while lining up the center marks with the marking-off lines. Cover the strain gage with the accessory polyethylene sheet.

③ Remove grease from bonding surface and clean.

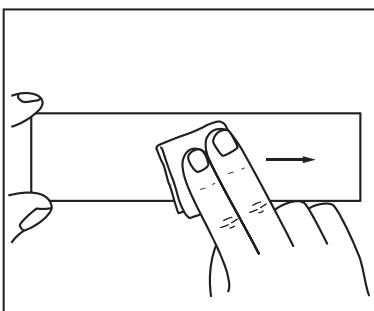

Using an industrial tissue paper dipped in acetone, clean the gage bonding site. Strongly wipe the surface in a single direction to collect dust and then remove by wiping in the same direction. Reciprocal wiping causes dust to move back and forth and does not ensure cleaning.

⑦ Press strain gage.

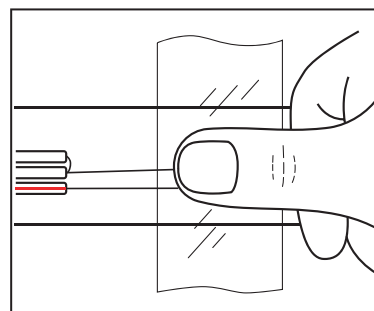

Press it over the sheet with a thumb. Quickly perform steps ⑤ to ⑦ as a series of actions.

④ Decide bonding position.

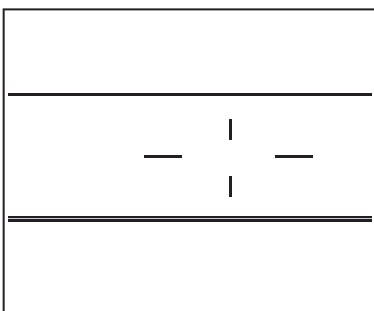

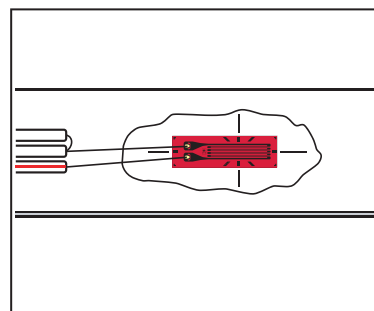

Mark the measuring site in the strain direction. Use a 4H pencil or a marking-off pin. When using a marking-off pin, take care not to deeply scratch the gage bonding surface.

⑧ Complete bonding work.

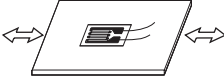
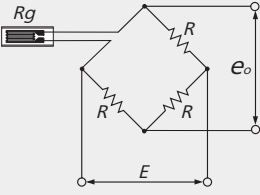
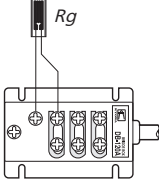
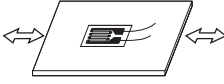
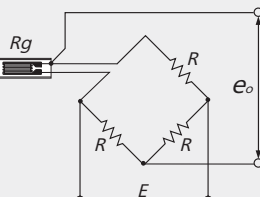
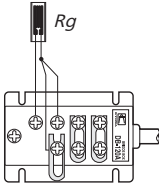
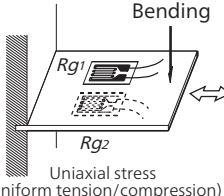
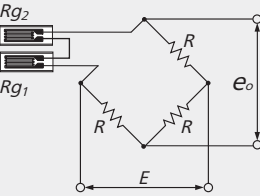
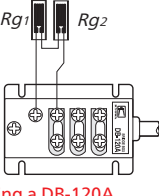
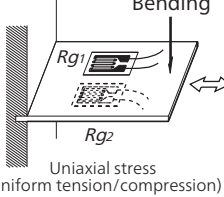
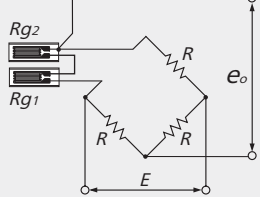
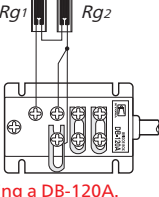
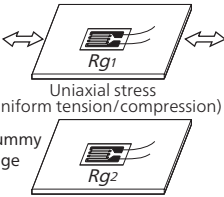
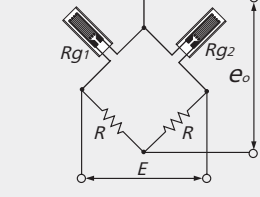
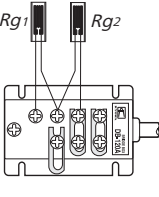
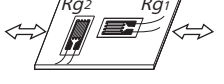
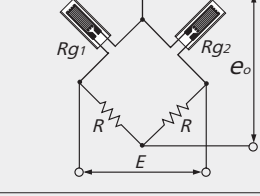
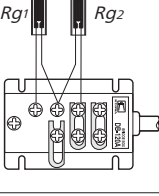
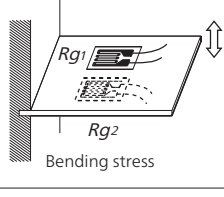
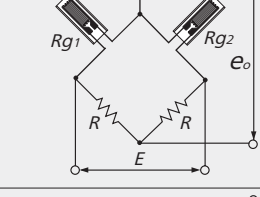
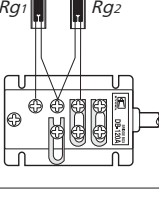

After pressing the strain gage with a thumb for one minute or so, remove the polyethylene sheet and make sure the strain gage is securely bonded. The above steps complete the bonding work. However, good measurement results are available after 60 minutes of complete curing of the adhesive.

How to Form Strain-gage Bridge Circuits

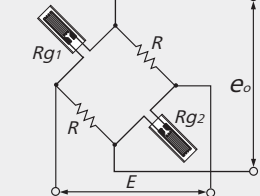
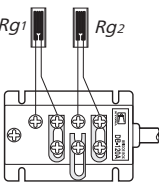
No.	Names	Sample Application	Circuits	Output	Remarks	Bridge Box DB-120A,350A
1	Active quarter-bridge 2-wire system	 <p style="text-align: center;">Uniaxial stress (Uniform tension/compression)</p>		$e_o = \frac{E}{4} K_s \cdot \epsilon_o$ <p> K_s: Gage factor ϵ_o: Strain E: Excitation voltage e_o: Output voltage R_g: Gage resistance R: Fixed resistance </p>	Suitable for environments with little ambient temperature change; no temperature compensation. x 1 output	
2	Active quarter-bridge 3-wire system	 <p style="text-align: center;">Uniaxial stress (Uniform tension/compression)</p>		$e_o = \frac{E}{4} K_s \cdot \epsilon_o$ <p> K_s: Gage factor ϵ_o: Strain E: Excitation voltage e_o: Output voltage R_g: Gage resistance R: Fixed resistance </p>	No temperature compensation; thermal effect of lead wires cancelled. x 1 output	
3	Active quarter-bridge (Dual series gages) 2-wire system (For cancelling bending strain)	 <p style="text-align: center;">Uniaxial stress (Uniform tension/compression)</p>		$e_o = \frac{E}{4} K_s \cdot \epsilon_o$ <p> R_{g1}.....Strain: ϵ_1 R_{g2}.....Strain: ϵ_2 $\epsilon_o = \frac{\epsilon_1 + \epsilon_2}{2}$ </p> <p> R: Fixed resistance $R = R_{g1} + R_{g2}$ </p> <p style="color: red;">E.g. R_{g1} & R_{g2} are 60-ohm gages, if using a DB-120A.</p>	No temperature compensation; bending strain cancelled. x 1 output	
4	Active quarter-bridge (Dual series gages) 3-wire system (For cancelling bending strain)	 <p style="text-align: center;">Uniaxial stress (Uniform tension/compression)</p>		$e_o = \frac{E}{4} K_s \cdot \epsilon_o$ <p> R_{g1}.....Strain: ϵ_1 R_{g2}.....Strain: ϵ_2 $\epsilon_o = \frac{\epsilon_1 + \epsilon_2}{2}$ </p> <p> R: Fixed resistance $R = R_{g1} + R_{g2}$ </p> <p style="color: red;">E.g. R_{g1} & R_{g2} are 60-ohm gages, if using a DB-120A.</p>	No temperature compensation; bending strain cancelled; thermal effect of lead wires cancelled. x 1 output	
5	Active-dummy half-bridge system	 <p style="text-align: center;">Uniaxial stress (Uniform tension/compression)</p>		$e_o = \frac{E}{4} K_s \cdot \epsilon_o$ <p> K_s: Gage factor ϵ_o: Strain E: Excitation voltage e_o: Output voltage R_{g1}.....Strain: ϵ_o R_{g2}.....Strain: 0 </p>	Temperature compensation; thermal effect of lead wires cancelled. x 1 output	
6	Orthogonal* active half-bridge system	 <p style="text-align: center;">Uniaxial stress (Uniform tension/compression)</p>		$e_o = \frac{(1+\nu)}{4} E K_s \cdot \epsilon_o$ <p> ν: Poisson's ratio R_{g1}, R_{g2}: Gage resistance R_{g1}.....Strain: ϵ_o R_{g2}.....Strain: $-\nu \epsilon_o$ R: Fixed resistance </p>	Temperature compensation; thermal effect of lead wires cancelled. x (1+ ν) output	
7	Active half-bridge system (For bending strain measurement)	 <p style="text-align: center;">Bending stress</p>		$e_o = \frac{E}{2} K_s \cdot \epsilon_o$ <p> R_{g1}.....Strain: ϵ_o R_{g2}.....Strain: $-\epsilon_o$ R: Fixed resistance </p>	Temperature compensation; thermal effect of lead wires cancelled; compressive/tensile strain cancelled. x 2 output	
8	Opposite-leg active half-bridge 2-wire system	 <p style="text-align: center;">Uniaxial stress (Uniform tension/compression)</p>		$e_o = \frac{E}{2} K_s \cdot \epsilon_o$ <p> R_{g1}.....Strain: ϵ_o R_{g2}.....Strain: ϵ_o R: Fixed resistance </p>	No temperature compensation; x 2 output bending strain cancelled by bonding to the front and rear.	

No.	Names	Sample Application	Circuits	Output	Remarks	Bridge Box DB-120A,350A
9	Opposite-leg active half-bridge 3-wire system Number of gages: 2	 Uniaxial stress (Uniform tension/compression)		$e_o = \frac{E}{2} K_s \cdot \epsilon_o$ $Rg_1 \dots \dots \text{Strain: } \epsilon_o$ $Rg_2 \dots \dots \text{Strain: } \epsilon_o$ R : Fixed resistance	No temperature compensation; thermal effect of lead wires cancelled; x 2 output bending strain cancelled by bonding to the front and rear.	
10	Active full-bridge system (For bending strain measurement) Number of gages: 4	 Bending stress		$e_o = K_s \cdot \epsilon_o \cdot E$ $Rg_1, Rg_3 \dots \dots$ Bending strain: ϵ_o $Rg_2, Rg_4 \dots \dots$ Bending strain: $-\epsilon_o$	Temperature compensation; thermal effect of lead wires cancelled; compressive/tensile strain cancelled. x 4 output	
11	Orthogonal active full-bridge system Number of gages: 4	 Uniaxial stress (Uniform tension/compression)		$e_o = \frac{(1+\nu)E}{2} K_s \cdot \epsilon_o$ ν : Poisson's ratio $Rg_1, Rg_3 \dots \dots$ Strain: ϵ_o $Rg_2, Rg_4 \dots \dots$ Strain: $-\nu \epsilon_o$	Temperature compensation; thermal effect of lead wires cancelled. bending strain cancelled. x2 (1+ν) output	
12	Active-dummy full-bridge system Number of gages: 4	 Active gages Uniaxial stress (Uniform tension/compression) Dummy gages		$e_o = \frac{E}{2} K_s \cdot \epsilon_o$ $Rg_1, Rg_3 \dots \dots$ Strain: ϵ_o $Rg_2, Rg_4 \dots \dots$ Strain: 0	Temperature compensation; thermal effect of lead wires cancelled; x 2 output bending strain cancelled by bonding to the front and rear.	
13	Active half-bridge system (For twisting strain measurement) Number of gages: 2	 Twisting strain		$e_o = \frac{E}{2} K_s \cdot \epsilon_o$ $Rg_1 \dots \dots$ Twisting strain: ϵ_o $Rg_2 \dots \dots$ Twisting strain: $-\epsilon_o$ R : Fixed resistance	Temperature compensation; thermal effect of lead wires cancelled. x 2 output	
14	Active full-bridge system (For twisting strain measurement) Number of gages: 4	 Twisting strain		$e_o = K_s \cdot \epsilon_o \cdot E$ $Rg_1, Rg_3 \dots \dots$ Twisting strain: ϵ_o $Rg_2, Rg_4 \dots \dots$ Twisting strain: $-\epsilon_o$	Temperature compensation; thermal effect of lead wires cancelled; bending strain cancelled; compressive/tensile strain cancelled. x 4 output	
15	4-active quarter-bridge system (For average strain measurement) Number of gages: 4	 Average strain		$e_o = \frac{E}{4} K_s \cdot \epsilon_o$ $\epsilon_o = \frac{\epsilon_1 + \epsilon_2 + \epsilon_3 + \epsilon_4}{4}$ R : Fixed resistance $Rg = R$ $R = Rg_1 = Rg_2 = Rg_3 = Rg_4$	No temperature compensation; average strain x 1 output	

Relationship between equivalent strain and voltage

The output of a strain-gage bridge is expressed as equivalent strain ($\times 10^{-6}$ strain) or an output voltage (mV/V or μ V/V) against the excitation voltage. The strain quantity and the output voltage have the following relation:

$$e_o = \frac{E}{4} K_s \cdot \epsilon_o$$

If the excitation voltage $E = 1$ V and the gage factor $K_s = 2.00$, $2e_o = \epsilon_o$. Thus, equivalent strain output is always 2 times larger than bridge output voltage.

E.g. $1.5 \text{ mV/V} = 1500 \mu\text{V/V} \rightarrow 3000 \times 10^{-6}$ strain

Static Strain and Dynamic Strain

Static Strain Measurement

Static strain is a strain whose magnitude does not change as time passes or changes extremely slowly. If the force applied to a structure is constant, the strain is constant, making it possible to be read on an analog or digital indicator. In many cases, however, static strain measurement is performed on multiple channels, and thus scanners, and strain indicators are used in combination.

Measurement of strain applied to a bridge by a stopped vehicle

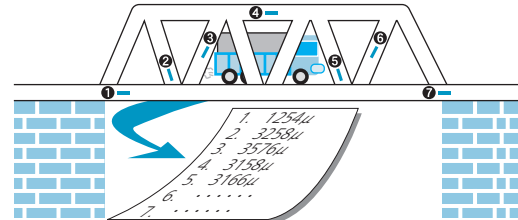

Measurement of strain applied to a bridge by a stopped vehicle

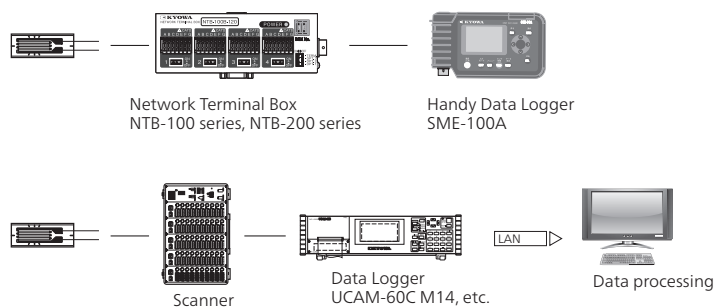

Dynamic Strain Measurement

Dynamic strain is a strain whose magnitude changes as time passes or is initiated by vibration or impact. Since ever-changing strain cannot be read out on analog and digital indicators, a data recorder or analog recorder has been used to obtain the detected data. Recently, a high-speed interface that connects the dynamic strain amplifier with a PC or a multichannel digital memory recorder analyzer that has a high-speed AD converter and large-capacity memory is used to acquire and analyze the detected data.

Measurement of strain applied to a bridge by moving vehicles

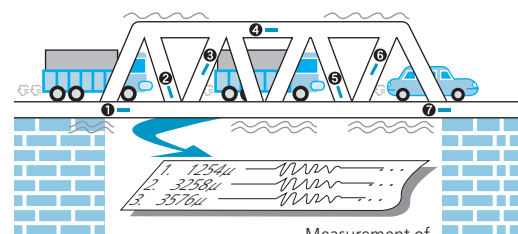

Measurement of strain applied to a bridge by moving vehicles

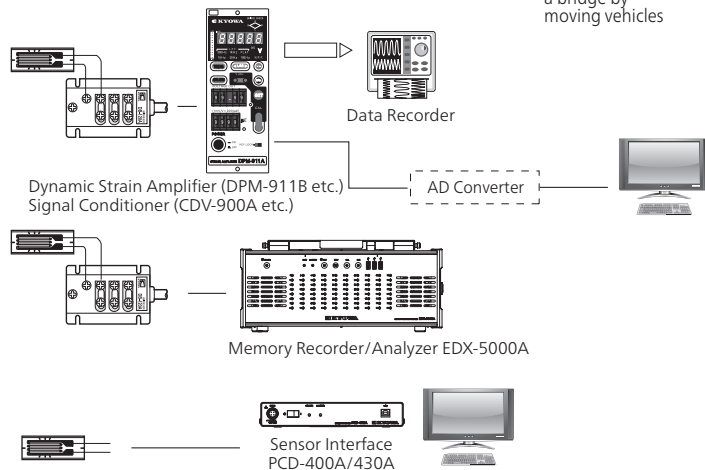

Simple static strain measurement with digital indicator

Strain values are measured with a digital static strain indicator SME-100A, etc. For multichannel measurement, multiple switch boxes are used.

Multichannel measurement in short time and for data processing

UCAM series data loggers that enable correction, calculation and automatic measurement are used together with applicable USB scanners.

The UCAM-60C M14 is used if the PC is not used in conjunction, and the UCAM-65C M14 is used for online measurement with the PC connected constantly. The UCAM-550A enables simultaneous sampling on all channels and is used for measurement of static to quasi-dynamic phenomena fluctuating at several cycles per second. Acquired data can be graphically displayed and analyzed on the PC.

Simple measurement of dynamic strain initiated by vibration, etc.

Dynamic strain fluctuating at up to 200 Hz can be measured simply with the PCD-400A or PCD-430A sensor interface. The sensor interface is equipped with bridge circuits, dynamic strain amplifiers and AD converters, which enable its direct connection with the PC. Acquired data can be displayed in either graphic or digital format and processed on the PC.

Measurement of various signals including impact-initiated dynamic strain

Kyowa provides measuring instruments which enable data acquisition for quick phenomena such as impact-initiated waveform as well as simultaneous input of voltage, thermocouple, pulse and digital signals together with strain gage and strain gage transducer signals. A dedicated software program is available for PC-aided analysis of acquired digital data of dynamic phenomena.

As sensing elements for transducers

Based on strain gages, various kinds of transducers are manufactured. These transducers are intended not to obtain strain data but to measure physical quantities such as load, pressure, acceleration, displacement and torque. For direct reading of such physical quantities, measuring instruments are available for connection to transducers.

Various applications of strain gages

Load Measurement

A strain gage bonded to a pillar enables detection of the force and load applied to the pillar.

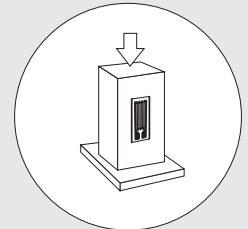

Vibration/Acceleration Measurement

A strain gage bonded to a thin leaf spring enables detection of the cycle, frequency and magnitude of the vibration and acceleration the leaf spring receives.

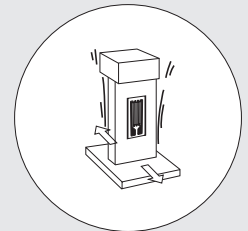

Displacement Measurement

A strain gage bonded to a thin leaf spring detects the bending strain the leaf spring receives, thereby enabling measurement of the amount of movement or displacement the spring is undergoing.

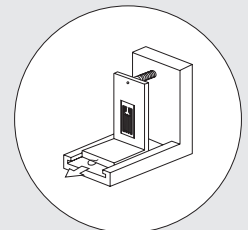

Torque Measurement

A strain gage bonded to an automobile propeller shaft or the rotating shaft of a drilling machine enables measurement of the transmission force, i.e. the torque, the shaft provides.

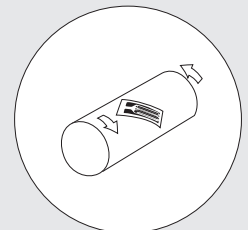

Pressure Measurement

A strain gage bonded to a diaphragm enables detection of the fluid or air pressure the diaphragm receives. As a rule, the strain gage is bonded to the rear of the diaphragm so that the strain gage will not be damaged by directly receiving pressure.

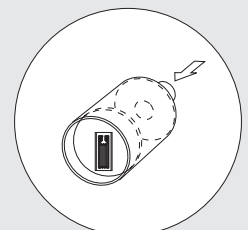

■ Selecting Strain Gages

Select the most suitable strain gage for the measuring purpose, with the measuring object and conditions considered.
Select the lead-wire cable and adhesive which meet the measuring environment.
Also, consider various accessories available for protection against severe environments and for labor saving.

1

Selecting a strain gage based on operating temperatures and other measuring conditions

→P.19

Basically, a strain gage is selected based on the material of the measuring object and the operating environmental temperature.
This section facilitates selection of a strain gage based on each measuring material and temperature range.

2

Selecting a strain gage based on operating environment and purpose

→P.20

This section describes the materials and features of strain gages, and provides data such as self-temperature-compensation ranges. Consult this section to select a suitable strain gage based on its specific characteristics.

3

Selecting the type and the length of a lead-wire cable for the gage selected in 1 or 2

→P.22

After selecting a strain gage, select the type and length of lead-wire cable by referring to this section.

4

Selecting a lead-wire cable based on operating temperature range and connection examples

→P.24

From among various types available for high- to low-temperature applications, select the most suitable lead-wire cable for the measuring purpose.

5

Adhesives and bonding tools

→P.26

Select a suitable adhesive for each measuring environment by referring to this section.

6

Gage terminals and other accessories

→P.30

If required, select a gage terminal and coating agent by referring to this section.

1

Selecting a strain gage based on operating temperatures and other measuring conditions

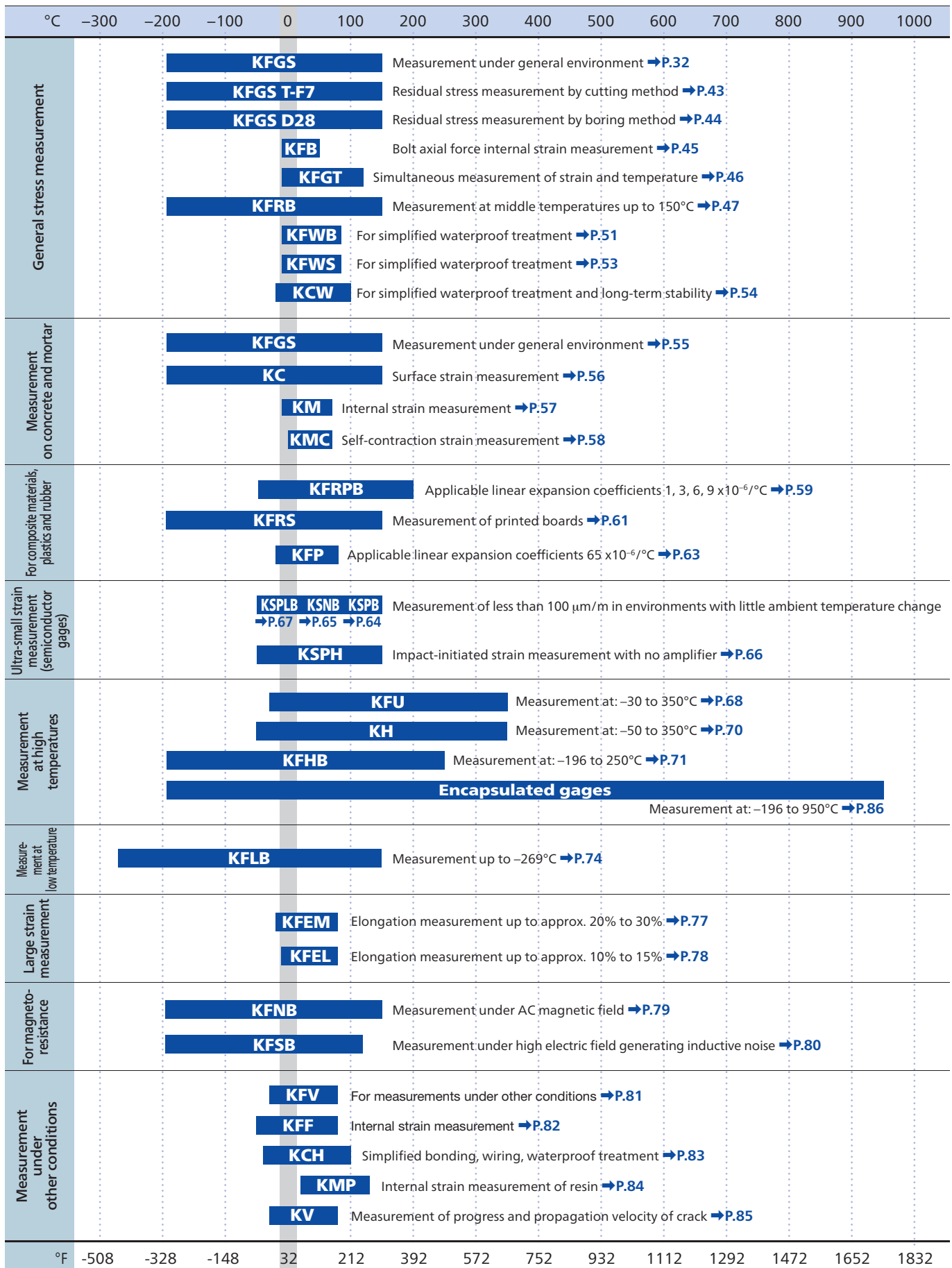

* The temperatures stated above are operating temperature.

2

Selecting a strain gage based on operating environment and purpose

	Models/ series designation		Materials		Operating temperature in combination with major adhesives after curing (°C) *1	Self- temperature- compensation (°C)	Applicable linear expansion coefficients (x10 ⁻⁶ /°C)	Strain limits at normal temperature (Approx.) *2	Fatigue lives at normal temperature (Times) *3	Pages
			Resistive elements	Bases						
For general stress measurement	General-purpose Foil Strain Gages KFGS	For general purpose	CuNi alloy foil	Polyimide	<u>CC-33A</u> -196 to 120 CC-36 -30 to 100 EP-340 -55 to 150 PC-600 -196 to 150	10 to 100	5, 11, 16, 23, 27	5.0%	1.2x10 ⁷	→P.32
		For sensing element of transducers			PC-600 -196 to 150 EP-340 -55 to 150	10 to 100	11, 16, 23, 27	5.0%	1.2x10 ⁷	→P.42
		For concrete			<u>CC-35</u> -10 to 80	10 to 100	11	5.0%	1.2x10 ⁷	→P.55
		Concentrated stress measurement			CC-33A -196 to 120 CC-36 -30 to 100 EP-340 -55 to 150 PC-600 -196 to 150	10 to 100	11, 16, 23, 27	—	—	→P.38
		Residual stress measurement			CC-33A -196 to 120 CC-36 -30 to 100 EP-340 -55 to 150 PC-600 -196 to 150	10 to 100	11, 16, 23, 27	—	—	→P.43
	Strain Gages for Measuring Axial Tension of Bolt KFB		CuNi alloy foil	Polyimide	EP-370 Normal temp. to 50	—	—	—	—	→P.45
	Foil Strain Gages with a Temperature Sensor KFGT		CuNi alloy foil	Polyimide	<u>CC-33A</u> -10 to 120 CC-36 -10 to 100 EP-340 -10 to 120	10 to 100	11, 16, 23, 27	3%	1x10 ⁶	→P.46
	Foil Strain Gages KFRB	Strain measurement at mid tempera- ture, for transducers	NiCr alloy foil	Polyimide	PC-600 -196 to 150 CC-33A -196 to 120 EP-340 -55 to 150	0 to 150	11, 16, 23	2.2%	1x10 ⁶	→P.47
		Concentrated stress measurement			PC-600 -196 to 150 CC-33A -196 to 120 EP-340 -55 to 150	0 to 150	11, 16, 23	—	—	→P.50
	Waterproof Foil Strain Gages KFWB		CuNi alloy foil	Polyimide	<u>CC-33A</u> -10 to 80 CC-36 -10 to 80 EP-340 -10 to 80	10 to 80	11, 16, 23	2.8%	3x10 ⁴	→P.51
	Small-sized Waterproof Foil Strain Gages KFWS		CuNi alloy foil	Polyimide	<u>CC-33A</u> -10 to 80 CC-36 -10 to 80 EP-340 -10 to 80	10 to 80	11, 16, 23	5.0%	3x10 ⁴	→P.53
	Weldable Waterproof Foil Strain Gages KCW		NiCr alloy foil	Stainless steel	(Spot welding) -20 to 100	10 to 90	11	—	—	→P.54
	Wire Strain Gages KC		CuNi alloy wire	Paper base + phenol-epoxy	CC-35 -30 to 120	10 to 60	11	1.8%	1.5x10 ⁵	→P.56
Embedded Strain Gages KM		CuNi alloy	Acrylate	(Embedment) -10 to 70	0 to 50	11	0.2%	—	→P.57	
Concrete-embedded Strain Gages KMC		CuNi alloy wire	Silicone	(Embedment) Normal temp. to 70	—	—	0.3%	—	→P.58	
For composite materials, plastics and rubber	Foil Strain Gages for Composite Materials KFRPB		NiCr alloy foil	Polyimide	EP-34B -55 to 200 CC-33A -196 to 120	0 to 150	1, 3, 6, 9	2.2%	1x10 ⁶	→P.59
	Foil Strain Gages for Printed Boards KFRS		NiCr alloy foil	Polyimide	CC-33A -196 to 120 PC-600 -196 to 150	-30 to 120	13	1.6%	2x10 ⁶	→P.61
	Foil Strain Gages for Plastics KFP		CuNi alloy foil	Polyimide	EP-34B -20 to 80 CC-33A -20 to 80 CC-36 -20 to 80	10 to 80	65	3.0%	1x10 ⁶	→P.63
For ultra-small strain measurement	Semiconductor Strain Gages KSPB	Ultra-small strain: for sensing element of highly sensitive transducers	P type Si	Polyimide	CC-33A -50 to 120 EP-340 -50 to 150	—	—	0.3%	*A 2x10 ⁶	→P.64
		Ultra-small strain: 2- element, temperature- compensation type	P type Si N type Si	Polyimide	CC-33A -50 to 120 EP-340 -50 to 150	20 to 50	11	0.15%	*A 2x10 ⁶	→P.64
	Self-temperature-compensation Semiconductor Strain Gages KSNB		N type Si	Polyimide	EP-340 -50 to 150 <u>CC-33A</u> -50 to 120 CC-36 -30 to 100	20 to 50	11, 16	0.1%	*A 2x10 ⁶	→P.65
	High-output Semiconductor Strain Gages KSPH		P type Si	Paper base + phenol-epoxy	CC-33A -50 to 120 CC-36 -30 to 100	—	—	0.3%	*A 2x10 ⁶	→P.66
	Ultra Linear Semiconductor Strain Gages KSPLB		P type Si	Polyimide	CC-33A -50 to 120 EP-340 -50 to 150	—	—	0.15%	*A 2x10 ⁶	→P.67
Notes	<p>*1. Underlined adhesives are those used for strain limit tests and fatigue life tests at normal temperature.</p> <p>*2. Typical values with uniaxial gages. The strain limit is the mechanical strain when the difference between the strain reading and mechanical strain upon applying a simple tension load to the test piece is greater than ±10% of the mechanical strain or when the strain gage is disconnected or detached. *1%=10000 µm/m</p> <p>*3. Typical values with uniaxial gages. Strain level: ±1500 µm/m; *A: ±1000 µm/m; *B: ±500 µm/m</p>									



	Models/ series designation	Materials		Operating temperature in combination with major adhesives after curing (°C) *1	Self- temperature- compensation (°C)	Applicable linear expansion coefficients (x10 ⁻⁶ /°C)	Strain limits at normal temperature (Approx.) *2	Fatigue lives at normal temperature (Times) *3	Pages
		Resistive elements	Bases						
For high temperature	Encapsulated Gages KHXC	Heat-resistant special alloy wire	Heat-resistant metal	(Spot welding) -196 to 950	25 to 950	11, 13	—	—	→P.86
	Encapsulated Gages KHCV	Heat-resistant special alloy wire	Heat-resistant metal	(Spot welding) 25 to 800	—	— (Dynamic measurement)	—	—	→P.86
	Encapsulated Gages KHCR	Heat-resistant special alloy wire	Heat-resistant metal	(Spot welding) 25 to 750	25 to 750	11, 13, 16	—	—	→P.86
	Encapsulated Gages KHCS	Heat-resistant special alloy wire	Heat-resistant metal	(Spot welding) -196 to 750	25 to 750	11, 13, 16	—	—	→P.86
	Encapsulated Gages KHCM	Heat-resistant special alloy wire	Heat-resistant metal	(Spot welding) -196 to 650	25 to 650	11, 13, 16	—	—	→P.86
	Encapsulated Gages KHC	NiCr alloy wire	Heat-resistant metal	(Spot welding) -196 to 550	Normal temp. to 500	11, 13, 16	—	—	→P.86
	High-temperature Foil Strain Gages KFU	NiCr alloy foil	Polyimide	<u>PI-32</u> -30 to 350	10 to 300	11, 16, 23	1.9%	*A 1.5×10 ⁵ (300°C)	→P.68
	High-temperature Foil Strain Gages KH	NiCr alloy foil	Stainless steel	(Spot welding) -50 to 350	10 to 300	11, 16	0.5%	*B 1×10 ⁷	→P.70
	High-temperature Foil Strain Gages KFHB	NiCr alloy foil	Polyimide	<u>PC-600</u> -196 to 250 <u>EP-34B</u> -55 to 200 <u>PI-32</u> -196 to 250	10 to 250	11, 16, 23	2.1%	—	→P.71
For low temp.	Low-temperature Foil Strain Gages KFLB	NiCr alloy foil	Polyimide	<u>PC-600</u> -269 to 150 <u>EP-270</u> -269 to 30 <u>CC-33A</u> -196 to 120	-196 to 50	5, 11, 16, 23	2.2%	1×10 ⁶	→P.74
For large strain measurement	Ultra-high-elongation Foil Strain Gages KFEM	CuNi alloy foil	Polyimide	<u>CC-36</u> -20 to 80	—	—	20% to 30%	—	→P.77
	High-elongation Foil Strain Gages KFEL	CuNi alloy foil	Polyimide	<u>CC-36</u> -10 to 80	—	—	10% to 15%	1×10 ⁶	→P.78
For antimagnetic applications	Non-inductive Foil Strain Gages KFNB	NiCr alloy foil	Polyimide	<u>PC-600</u> -196 to 150 <u>CC-33A</u> -196 to 120	0 to 150	11, 16, 23	1%	1×10 ⁴	→P.79
	Shielded Foil Strain Gages KFSB	CuNi alloy foil (120 Ω) NiCr alloy foil (350 Ω)	Polyimide	<u>CC-33A</u> -196 to 120 <u>EP-340</u> -55 to 120	10 to 100	11, 16, 23	0.5%	1×10 ⁴	→P.80
For hydrogen gas environments	Foil Strain Gage for Hydrogen Gas Environment KFV	Special alloy foil	Polyimide	<u>PC-600</u> -30 to 80	—	—	—	—	→P.81
Internal strain	Foil Strain Gages for Bending Strain Measurement KFF	CuNi alloy foil	Acrylate	<u>CC-33A</u> -50 to 80 <u>EP-340</u> -50 to 80	20 to 60	11, 16, 23	0.2%	*B 4×10 ⁶	→P.82
With protector	Foil Strain Gages with a Protector KCH	CuNi alloy foil	Polyimide	Protector: Stud bolt Strain gage <u>EP-340</u> , <u>CC-33A</u> -40 to 100	—	11	1%	*A 1.2×10 ⁶	→P.83
Embedded	Embedded Gage KMP		Aluminum	—	20 to 120	—	—	—	→P.84
Crack	Crack Gages KV	CuNi alloy foil	Paper base+ phenol-epoxy	<u>CC-33A</u> <u>CC-36</u> <u>PC-600</u>	—	—	—	—	→P.85
Notes	*1. Underlined adhesives are those used for strain limit tests and fatigue life tests at normal temperature. *2. Typical values with uniaxial gages. The strain limit is the mechanical strain when the difference between the strain reading and mechanical strain upon applying a simple tension load to the test piece is greater than ±10% of the mechanical strain or when the strain gage is disconnected or detached. *1%=10000 μm/m *3. Typical values with uniaxial gages. Strain level: ±1500 μm/m; *A: ±1000 μm/m; *B: ±500 μm/m								

3

Selecting the type and the length of lead-wire cable for the gage selected in 1 or 2

Virtually all Kyowa strain gages are delivered with a lead-wire cable pre-attached to ensure labor saving in gage bonding works by eliminating the need for soldering.

Types and lengths of the lead-wire cable for each gage are as follows.

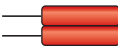
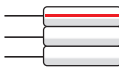
Models of Strain Gage		KFGS, KFRB, KFRPB, KFRS, KFP, KFLB, KFEL, KFEM	KFGS, KFRB, KFRPB, KFRS, KFP, KFLB	KFGS, KFRB, KFWB, KAWS, KC, KFRPB, KFRS, KFP, KFEL, KFEM			
		Type of lead-wire cables	2 polyester-coated copper wires -196 to 150°C	3 polyester-coated copper wires -196 to 150°C	 Vinyl-coated flat 2-wire cable -10 to 80°C		 Vinyl-coated flat 3-wire cable -10 to 80°C
				Uniaxial	Multiaxial	Uniaxial	Multiaxial
Lengths of lead-wire cable (*)	15 cm	N15C2	N15C3	L15C2R	L15C2S	L15C3R	L15C3S
	30 cm	N30C2	N30C3	L30C2R	L30C2S	L30C3R	L30C3S
	1 m	N1M2	N1M3	L1M2R	L1M2S	L1M3R	L1M3S
	3 m	—	—	L3M2R	L3M2S	L3M3R	L3M3S
	5 m	—	—	L5M2R	L5M2S	L5M3R	L5M3S
Models, etc.		Twisted for ≥ 50 cm		L-6 L-9 for ≥ 6 m		L-7 L-10 for ≥ 6 m	
Coating color		* KFEL, KFEM are only 2-wire system		 Red Red		 Red Stripe (Independent) White White	

***For other lead-wire cable lengths, contact us.**

- For 2-wire gages, the gage resistance indicated on the package includes that of the lead-wires.
- For 3-wire gages, the gage resistance indicated on the package is only for the gage itself, and does not include that of the lead-wires.
- Encapsulated gages are provided standard with an MI cable 2 m long and a soft cable 50 cm long.

See page 45 for KFB, page 54 for KCW, page 57 for KM, and page 71 for KH.









When ordering, specify the model of the strain gage and the code of the lead-wire cable with a space in between.

e.g.

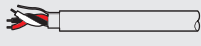
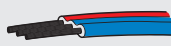
Model of strain gage

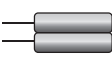
Code of lead-wire cable

KFGS-2-120-C1-11 **L1M3R**

KFGS, KFRB, KFRPB, KFRS, KFLB	KFNB, KFSB	KFRPB, KFHB, KFLB	KFU, KFHB	
 Mid-temperature 2-wire cable -100 to 150°C	 Mid-temperature 3-wire cable -100 to 150°C	 Vinyl-coated normal-temperature low-noise 3-wire cable -10 to 80°C	 Fluoroplastic-coated high/low-temperature 3-wire cable -269 to 250°C	 High/low-temperature 3-wire cable -269 to 350°C
R15C2	R15C3	J15C3	F15C3	H15C3
R30C2	R30C3	J30C3	F30C3	H30C3
R1M2	R1M3	J1M3	F1M3	H1M3
R3M2	R3M3	J3M3	F3M3	H3M3
R5M2	R5M3	J5M3	F5M3	H5M3
L-11	L-12	L-13	L-3	L-17
 Grey Grey	 Red (Independent) White Black	 Red (Independent) White Black	 Red (Independent) Blue Blue	 Black (Independent) Yellow Green

Types of lead-wire cable with glass-cloth tape



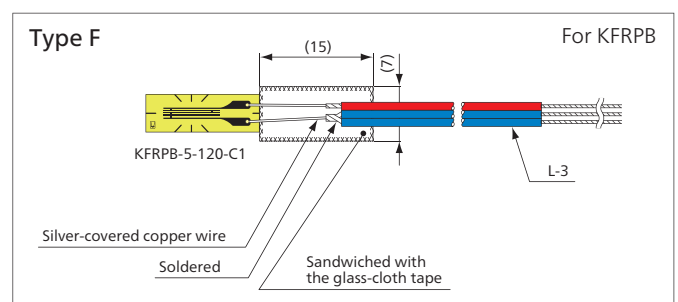
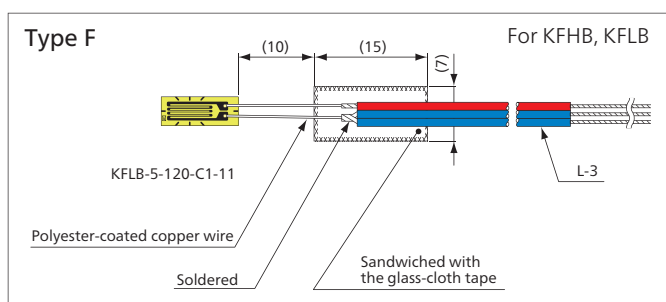
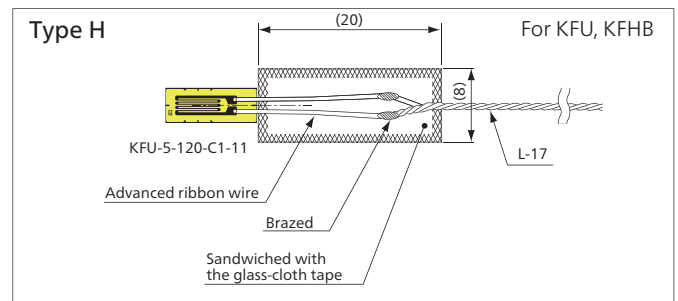
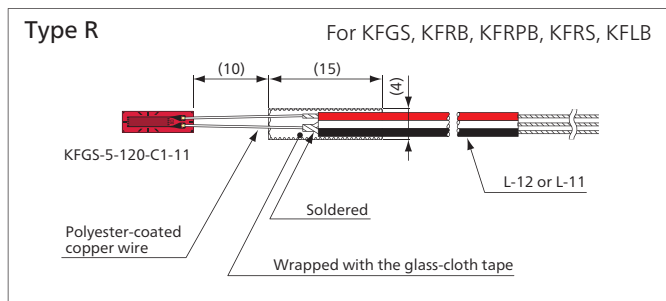









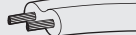

*The wire section of some types is sandwiched or wrapped with the glass-cloth tape for insulation and reinforcement. (See the figures below.)



4

Selecting a lead-wire cable based on operating temperature range and connection examples

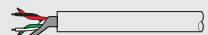
L-type lead-wire cables

Operating Temperature (°C)	Models	Types	Conductor Materials	Nominal Cross Section of Conductor (mm ²)	Number of Strands/Wire Diam. (mm)	Reciprocating Resistance per Meter (Ω)	Coated Wire Diameter (mm)	Lengths (m)
Normal temperature to 350	L-1	High-temperature lead wire 	CuNi alloy	0.07	1/φ0.30	14.20	φ0.50	50
-10 to 80	L-2	Vinyl-coated flat 3-wire cable 	Copper	0.30	12/φ0.18	0.12	φ2.30	100
-269 to 250	L-3	Fluoroplastic-coated high/low-temperature 3-wire cable 	Tin-plated copper	0.14	7/φ0.16	0.28	φ0.98	50
-10 to 80	L-5	Vinyl-coated flat 2-wire cable 	Copper	0.50	20/φ0.18	0.07	φ2.50	100
-10 to 80	L-6 (*1)	Vinyl-coated flat 2-wire cable 	Copper	0.08	7/φ0.12	0.44	φ1.00	
-10 to 80	L-7 (*2)	Vinyl-coated flat 3-wire cable 	Copper	0.08	7/φ0.12	0.44	φ1.00	
-10 to 80	L-9 (*1)	Vinyl-coated flat 2-wire cable 	Copper	0.11	10/φ0.12	0.32	φ1.00	
-10 to 80	L-10 (*2)	Vinyl-coated flat 3-wire cable 	Copper	0.11	10/φ0.12	0.32	φ1.00	
-100 to 150	L-11	Mid-temperature 2-wire cable 	Tin-plated copper	0.08	7/φ0.12	0.44	φ0.86	
-100 to 150	L-12	Mid-temperature 3-wire cable 	Tin-plated copper	0.08	7/φ0.12	0.44	φ0.86	
-10 to 80	L-13	Vinyl-coated normal-temperature low-noise 3-wire cable 	Tin-plated copper	0.09	7/φ0.13	0.46	φ3.50	
-50 to 90	L-14	Chloroprene-coated normal-temperature low-noise 4-wire cable 	Tin-plated copper	0.08	7/φ0.12	0.48	φ4.00	
-269 to 250	L-15	Fluoroplastic-coated high/low-temperature low-noise 3-wire cable 	Silver-plated copper	0.08	7/φ0.12	0.48	φ2.50	
-269 to 250	L-16	Fluoroplastic-coated high/low-temperature low-noise 4-wire cable 	Silver-plated copper	0.08	7/φ0.12	0.48	φ3.30	
-269 to 350	L-17	High/low-temperature 3-wire cable 	Nickel-plated copper	0.07	1/φ0.30	0.50	φ0.38	30

*1. These models have a suffix R, W, G, Y or B indicating the coating color; red, white, green, yellow or black. E.g. L-6B: Black vinyl coated.

*2. These models have a suffix WR, WL or WY indicating the stripe color; red, blue or yellow on white vinyl coating.

E.g. L-7WR: Red stripes on white coating.

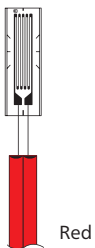
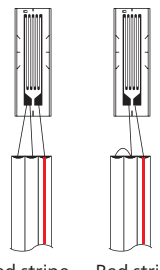
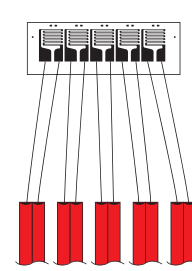
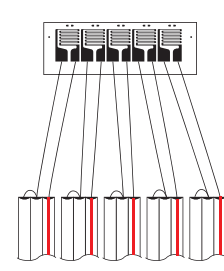
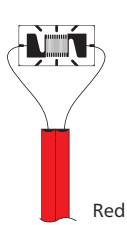
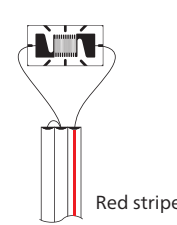
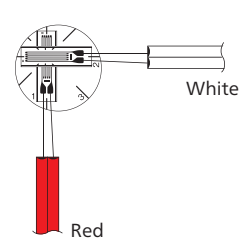
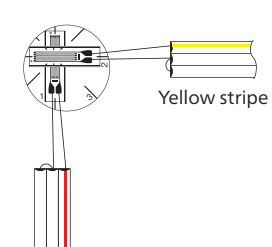
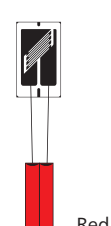
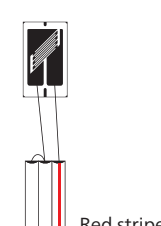
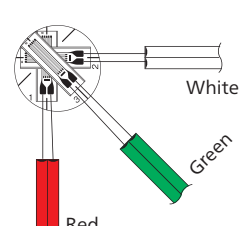
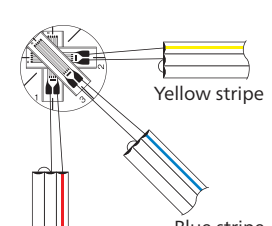
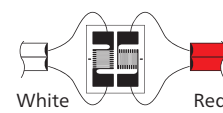
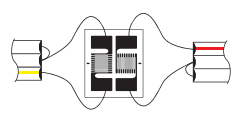
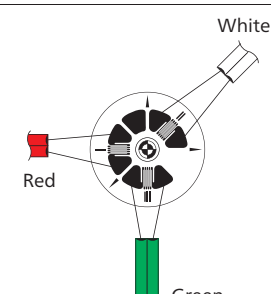
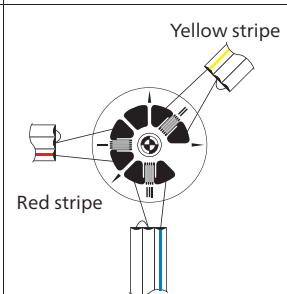
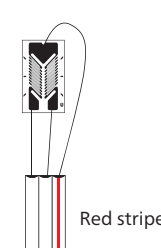
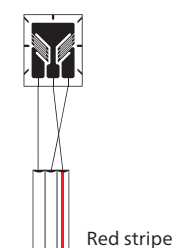
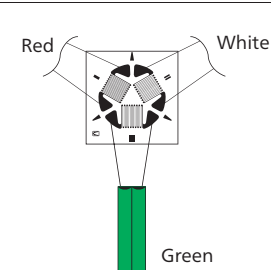
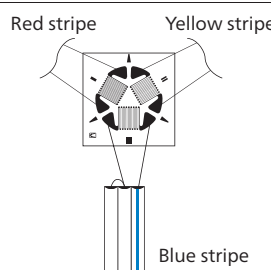
Cord Type	2-wire	3-wire	Cord Type	2-wire	3-wire
C1	 Red	 Red stripe Red stripe 2 connection methods depending on the models. (Same as D16 and D17.) *KFGS: Right only.	D9 or D19 or D39	 Red	 Red stripes
C2 or C3	 Red	 Red stripe	D16	 White Red	 Yellow stripe Red stripe
C15 or C16	 Red	 Red stripe	D17	 White Green Red	 Yellow stripe Blue stripe Red stripe
D1	 White Red	 Yellow stripe Red stripe	D28	 White Red Green	 Yellow stripe Red stripe Blue stripe
D2		 Red stripe	D31		 Red stripe
D4	 Red White Green	 Red stripe Yellow stripe Blue stripe			

5

Adhesives and bonding tools

Adhesives

To obtain good measurement results, the strain gage must be bonded firmly to the measuring object. Thus, it is important to select an adhesive suitable for the materials of both the object being measured and the gage base, as well as for the measuring conditions.

Models	Types	Operating Temperature (°C)	Major Applicable Materials	Curing Requirements
 CC-33A	Instantaneous adhesive cured at normal temperature	-196 to 120 (Regular temperature: 20 to 80)	<ul style="list-style-type: none"> Metals (Steel, stainless steel, copper, aluminum alloys A1050, A2024, etc.) Plastics (Acrylate, PVC, nylon, etc.) Composite materials (CFRP, GFRP, PCB, etc.) Rubber 	<ul style="list-style-type: none"> Apply finger pressure (100 to 300 kPa) for 15 to 60 seconds. (Then, leave the gage for 1 hour.) *The finger pressure application time differs depending on temperature and humidity conditions. The lower the temperature and humidity, the longer the finger pressure application time required.
 CC-35	Instantaneous adhesive cured at normal temperature	-30 to 120 (Regular temperature: 20 to 80)	<ul style="list-style-type: none"> Concrete Mortar Wood 	<ul style="list-style-type: none"> Apply finger pressure (100 to 300 kPa) for 30 to 180 seconds. (After curing, leave the gage for 1 hour or more.) *The finger pressure application time differs depending on temperature and humidity conditions. The lower the temperature and humidity, the longer the finger pressure application time required.
 CC-36	Instantaneous adhesive cured at normal temperature	-30 to 100 (Regular temperature: 20 to 80)	<ul style="list-style-type: none"> Metals (Steel, stainless steel, copper, aluminum alloys A1050, A2024, A7075, magnesium alloy, etc.) Plastics (Acrylate, PVC, nylon, polypropylene, etc.) Composite materials (CFRP, GFRP, PCB, etc.) Concrete Mortar Wood Rubber 	<ul style="list-style-type: none"> Apply finger pressure (100 to 300 kPa) for 30 to 60 seconds. (After curing, leave the gage for 1 hour or more.) *The finger pressure application time differs depending on temperature and humidity conditions. The lower the temperature and humidity, the longer the finger pressure application time required.
 EP-270	Cured at normal temperature	-269 to 30	<ul style="list-style-type: none"> Metals (Steel, stainless steel, aluminum alloy, etc.) 	<ul style="list-style-type: none"> Apply pressure (50±20 kPa) for 24 hours at approx. 25°C.
 EP-340	Cured at normal temperature or by heating	-55 to 150	<ul style="list-style-type: none"> Metals (Steel, stainless steel, aluminum alloy, etc.) 	<ul style="list-style-type: none"> Apply pressure (100±50 kPa) for 24 hours at approx. 25°C or for 2 hours at 80°C.
 EP-34B	Cured at normal temperature or by heating	-55 to 200	<ul style="list-style-type: none"> Metals (Steel, stainless steel, copper, aluminum alloy, etc.) Plastics (Acrylate, PVC, etc.) Composite materials (CFRP, GFRP, PCB, etc.) 	<ul style="list-style-type: none"> Apply pressure (30 to 50 kPa) for 24 hours at approx. 25°C or for 2 hours at 80°C. Pressing is possible with tape.
 EP-370	Cured by normal temperature + heating	Normal temperature to 50	<ul style="list-style-type: none"> Metals (Steel, stainless steel, copper, aluminum alloy, etc.) Plastics (Acrylate, PVC, etc.) 	<ul style="list-style-type: none"> Keep at normal temperature for 24 hours and heat it for 5 hours at 80°C.
 PC-600	Cured by heating	-269 to 250	<ul style="list-style-type: none"> Metals (Steel, stainless steel, copper, aluminum alloy, etc.) 	<ul style="list-style-type: none"> Apply pressure (150 to 300 kPa) for 1 hour at 80°C →2 hours at 130°C →2 hours at 150°C.
 PI-32	Cured by heating	-269 to 350	<ul style="list-style-type: none"> Metals (Steel, stainless steel, copper, aluminum alloy, etc.) 	<ul style="list-style-type: none"> Apply pressure (200 to 500 kPa) for 1 hour at 100°C →2 hours at 200°C →Remove pressure and perform aging.*1 *If it is difficult to heat at 200°C, 2 h at 200°C may be changed to 5 h at 160°C with all other conditions followed.

Note: The stated operating temperature range is for the adhesive only, and may differ depending on combinations with gages. When using the adhesives and gages together, read the attached instruction manual carefully.

Category	Capacity	Features	Major Applicable Gages
1 type of cyanoacrylate liquid	2 g × 1 or 2 g × 5 (CC-33A×5)	<ul style="list-style-type: none"> •Suitable for bonding general-purpose gages which are used for general stress measurement at normal temperature. •Quick curing ensures smooth bonding workability. •Enables measurement in approximately 1 hour from bonding. 	KFGS KFGT KFRB KFVB KFWS KFRPB KFRS KFP KSPB KSNB (Excl. E5) KSPH KSPLB KFLB KFNB KFSB KFF KCH KV
1 type of cyanoacrylate liquid	2 g × 1 or 2 g × 5 (CC-35×5)	<ul style="list-style-type: none"> •High viscosity makes it suitable for bonding to porous materials such as lumber and concrete. •Suitable for bonding general-purpose gages which are used for general stress measurement at normal temperature. 	KFGS KFGT KFRB KC KFRPB KFP
1 type of cyanoacrylate liquid	2 g × 1 or 2 g × 5 (CC-36×5)	<ul style="list-style-type: none"> •Suitable for bonding a high-elongation gage (such as KFEM and KFEL) at normal temperature. •Suitable for bonding to non-adhesive materials such as aluminum alloy (A7075) and magnesium alloy. •High peeling resistance, high impact resistance and less aging deterioration of bonding strength 	KFEM KFEL KFGS KFGT KFRB KFVB KFWS KFRPB KFRS KFP KSPB KSNB (Excl. E5) KSPH KSPLB KFF KV
2 types of epoxy liquid mixed	50 g (Main agent: 25 g Curing agent: 25 g)	<ul style="list-style-type: none"> •Suitable for bonding gages for strain measurement at very low temperature. 	KFLB
2 types of epoxy liquid mixed	30 g (Main agent: 6 g × 4 Curing agent: 1.5 g × 4)	<ul style="list-style-type: none"> •Suitable for bonding gages for strain measurement at mid temperature. 	KFGS KFRB KFVB KFWS KFGT KFF KFSB KSNB (Excl. E5)
2 types of epoxy liquid mixed	30.8 g (Main agent: 5.6 g × 4 Curing agent: 2.1 g × 4)	<ul style="list-style-type: none"> •Suitable for bonding gages for strain measurement at mid temperature and for bonding gages for transducers. 	KFRPB KFP KFHB
2 types of epoxy liquid mixed	40 g (Main agent: 30 g Curing agent: 10 g)	<ul style="list-style-type: none"> •Low viscosity makes it suitable for bonding gages KFB in bolts. 	KFB
1 heating type of phenol liquid	100 g	<ul style="list-style-type: none"> •Suitable for bonding gages for strain measurement at low, mid and high temperatures and for bonding gages for transducers. 	KFGS KFRB KFHB KFLB KFNB
1 heating type of polyimide liquid	20 g	<ul style="list-style-type: none"> •Suitable for bonding gages for strain measurement at high temperature. 	KFU KFHB

*1 Place it in a heating furnace or the like, and perform aging according to the following requirement. (A temperature increasing speed should be about 5°C/minute.)

KFU gage: Increase heating temperature from room temperature to 300°C, then maintain 300°C for 2 hours.

KFHB gage: Increase heating temperature from room temperature to 250°C, then maintain 250°C for 2 hours.

5

Adhesives and bonding tools

Gage Bonding Tool Kit

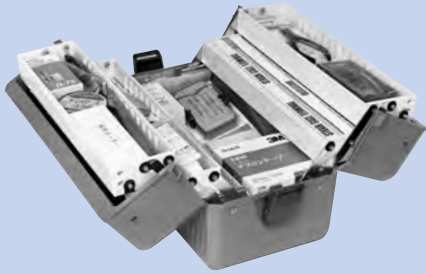

●GTK-77 NF Tool Kit NEW

This kit includes almost all tools, gage terminals, solder and other expendables required for gage bonding work.

Contents

Tool box, screwdriver set, tweezers (2 pcs), nippers, radio pliers, tape measure (2 m), stainless steel scale, protractor, sandpaper (#100, #320, 3 pcs each), soldering iron tip cleaner, knife, utility knife, scribe, soldering iron (35 W), compass, marking pencils (red, white), mending tape, pencils (4H, 6H, 2 pcs each), scissors, willow scissors, cotton swabs, clean paper, high-temperature solder, heat-resistant glass tube, heat resistant teflon tape, gage terminals (T-P1, T-P4, T-P5, T-P6, T-P7, T-P8, T-P9, T-P10, T-F2B, T-F3B, T-F7B, T-F8B, T-F10B, T-F13B, T-F17B, T-F25, T-F28), hair dryer (1200 W), insulation vinyl tape, table tap (2.5 m), soldering iron (ANTEX), silicone rubber (10 pcs), fluoroplastic sheets (10 pcs), gage presser G-MATE-B (1pc)

Note: The power supply of the electric goods is set to 100 VAC, as per Japanese specifications.
Note: The "GTK-77 AC220 NF" for 200 VAC, contact us.

●GTK-55K Tool Kit



This portable kit includes almost all items required for gage bonding work.

Contents

Tool box, tweezers (2 pcs), nippers, radio pliers, stainless steel scale, sandpaper (#180, #320, #600, and #1000, 4 pcs each), utility knife, scribe, pencils (4H, 3 pcs), tape, scissors, small scissors, cotton swabs, clean paper, gage terminals (T-F7B, T-F17B), vinyl tape, silicone rubber (10 pcs), fluoroplastic sheets (10 pcs), polyethylene sheets (SKF-28284, 100 pcs), gage presser G-MATE-B (1pc)

Note: Cleaner, strain gages and adhesives are not included. Please prepare them separately.

Gage Presser



●Gage Presser G-MATE

The G-MATE applies pressure to a bonded strain gage continuously until the adhesive is cured. It consists of a frame equipped with a strong ferrite magnet to firmly fix the object under testing and a pressure disk equipped with silicone sponge rubber and a coil spring to apply constant pressure to the strain gage.

Name	Models	Applications
Gage Mate	G-MATE-B	For normal temperature (Up to approx. 80 °C)
High-temperature Gage Mate	G-MATE-H	For high temperature (Up to approx. 150 °C)

6 pc/pkg

■ Compact Spot Welder

● GW-3C Compact Spot Welder

Developed to install encapsulated gages such as the KHCX, KHCS and KHC and to fix high-temperature lead wires and thermocouples, the GW-3C is an easy-to-use welder allowing continuously variable setting of welding energy.



CE

Specifications

Welding Energy	LOW: 0 to 25 Ws, continuously variable HIGH: 0 to 50 Ws, continuously variable
Welding Speed	1 Ws: 150 times/min, 5 Ws: 120 times/min, 10 Ws: 80 times/min, 20 Ws: 60 times/min, 50 Ws: 30 times/min
Power Supply	GW-3C: 100 VAC GW-3C M9: 220 VAC
Dimensions and Weight	183 W x 153 H x 313 D mm (Excluding protrusions), approx. 9 kg (Main body)
EMC Directive	EN61326-1 (Class A)
Low Voltage Directive	EN61010-1, EN61010-2-030 (Installation Category II, Pollution Degree 2, Measurement Category O)
Accessories	Square welding head, grounding clip (With 1.3-m long cable), 2 electrodes (GW-02), metal file, fuse (5 A), hexagon wrench, instruction manual
Options	Aluminum trunk (GW-01)











*Products corresponding to welding speed 50 Ws, approx. 180 times/min can also be manufactured.
(Note: Does not comply with overseas laws and regulations. For use in Japan only.) Please contact us for details.

6

Gage terminals and other accessories

Gage Terminals

A gage terminal is for connecting a strain gage and lead wires to protect the gage leads. It prevents the strain gage from receiving force and the gage leads from breaking or peeling off if the lead wires are pulled to some extent.

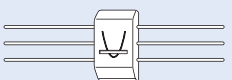
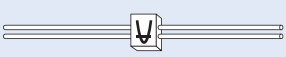
	Models	Dimensions (mm) (W x L x T)	Base Materials	Conductor Materials	Qty per Pack	Operating Temperature (°C)	Recommended Adhesives	Remarks
Foil types	 T-F2B RoHS	5-pole 14×55×0.1 1-pole 14×11×0.1	Glass epoxy	Copper foil	20 sheets (5 poles/sheet)	-196 to 120	CC-33A EP-34B	
	 T-F3B RoHS	5-pole 14×65×0.1 1-pole 14×13×0.1	Glass epoxy	Copper foil	20 sheets (5 poles/sheet)	-196 to 120	CC-33A EP-34B	For 3-wire system
	T-F13B RoHS	5-pole 14×65×0.15 1-pole 14×13×0.15	Glass epoxy + double-sided adhesive tape			-30 to 50	Not required	Self-bonding
	 T-F7B RoHS	5-pole 6×25×0.1 1-pole 6×5×0.1	Glass epoxy	Copper foil	20 sheets (5 poles/sheet)	-196 to 120	CC-33A EP-34B	
	T-F17B RoHS	5-pole 6×25×0.15 1-pole 6×5×0.15	Glass epoxy + double-sided adhesive tape			-30 to 50	Not required	Self-bonding
	 T-F8B RoHS	5-pole 4×30×0.1 1-pole 4×6×0.1	Glass epoxy	Copper foil	20 sheets (5 poles/sheet)	-196 to 120	CC-33A EP-34B	
	 T-F10B RoHS	15×50×0.1	Glass epoxy	Copper foil	10 sheets	-196 to 120	CC-33A EP-34B	Mainly for 5-element gages
	 T-F23 RoHS	5-pole 14×55×0.1 1-pole 14×11×0.1	Polyimide	Copper foil	20 sheets (5 poles/sheet)	-196 to 200, -196 to 120 with CC-33A	CC-33A EP-34B	For high temperature
	T-F24 RoHS	5-pole 9×40×0.1 1-pole 9×8×0.1						
	T-F25 RoHS	5-pole 6×25×0.1 1-pole 6×5×0.1						
 T-F26 RoHS	5-pole 14×55×0.1 1-pole 14×11×0.1	Polyimide	Copper foil	20 sheets (5 poles/sheet)	-196 to 350	PI-32	For high temperature	
T-F27 RoHS	5-pole 9×40×0.1 1-pole 9×8×0.1							
T-F28 RoHS	5-pole 6×25×0.1 1-pole 6×5×0.1							
 T-F29 RoHS	Outer: φ6 Inner: φ2.5	Glass epoxy	Copper foil	20 sheets	-196 to 120	EP-340, 370 CC-33A	For measuring axial tension of bolts	
Mold types	 T-P1	14×10×4	Styrol	Tin-plated copper wire	20 pcs	-30 to 80	CC-33A	Self-bonding
	T-P4	14×10×4.5	Styrol + double-sided adhesive tape			-30 to 50	Not required	Self-bonding
	 T-P5	6×6×2	ABS	Tin-plated copper wire	20 pcs	-30 to 120	CC-33A	
	T-P6	6×6×2.5	ABS + double-sided adhesive tape			-30 to 50	Not required	Self-bonding
	 T-P7	15×10×4	ABS	Tin-plated copper wire	20 pcs	-30 to 80	CC-33A	For 3-wire system
	T-P8	15×10×4.5	ABS + double-sided adhesive tape			-30 to 50	Not required	Self-bonding
	 T-P9	6×5×4	Heat-resistant styrol	Tin-plated copper wire	40 pcs	-30 to 90	CC-33A	
	T-P10	6×5×6	Heat-resistant styrol + rubber					Rubber on the rear face

Coating Agents

Coating agents are applied to gages and gage terminals to prevent gages from adsorbing moisture in outdoor or long-term measurements.



C-1B



C-4



C-5

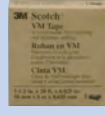

VMTAPE



ARALDITE



HAMATITE
Y-500-L



KE-4898-W

Models	C-1B	C-4	C-5	AK22	VMTAPE	ARALDITE	HAMATITE Y-500-L	KE-4898-W
Types	Hot-melt type	Hot-melt type	Rubber solvent type	Special clay	Press-fitting rubber type	2-liquid type (1:1)	Rubber solvent type	Silicone solvent type
Operating Temperature	-30 to 40°C	-50 to 60°C	-269 to 60°C	-30 to 120°C	-30 to 80°C	-50 to 100°C	-20 to 70°C	-50 to 200°C
Curing Requirements	Heat-melted & cured at normal temp.	Heat-melted & cured at normal temp.	Cured at normal temp.	Press-fitted	Press-fitted	24 h at normal temp.	Cured at normal temp.	Cured at normal temp.
Moisture & Waterproofness	◎	◎	◎	◎	○	△	○	△
Mechanical Protection	△	△	△	△	△	◎	△	△
Oil Resistance	△	△	△	△	△	○	△	△
Alcohol Resistance	○	○	○	○	○	○	○	○
Toluene Resistance	×	×	×	×	×	○	×	×
Alkalescent Resistance	○	○	○	○	○	○	△	△
Weak-acid Resistance	○	○	○	○	○	○	△	△
Contents	500 g	500 g	100 g	1 kg	38 mm×6 m	1.8 kg	1.5 kg	100 g
Materials	Paraffin wax	Microcrystalline wax	Butyl rubber	Butyl rubber + inorganic additive	Butyl rubber	Epoxy	Chloroprene rubber	Silicone
Color	White	White	Light yellow	Dark green	Black	Main agent: Light milk white Curing agent: Light yellow	Black	Milk white
Features	To be applied with a brush after heat melting. Suitable as an underlayer of multilayer coating.	Excellent cohesiveness makes it suitable for application to wall surfaces.	Minimal restriction in ultra-low temperature applications. Tube type	The clay-like shape ensures easy coating work.	The tape shape facilitates coating work.	Highly effective mechanical protection makes it suitable as an upper layer of multilayer coating.	Suitable as a final finish of multi-layer coating.	Highly heat-resistant coating agent. Tube type
Kyowa Models	C-1B	C-4	C-5	AK22	VMTAP	ARALDITE-C	HAMATITE Y-500-L	KE-4898W

◎: Excellent
○: Rather excellent
△: Rather inferior
×: Inferior

*When using, read the attached instruction manual carefully.

Accessories for High-temperature Gages

Accessories for high-temperatures gages.



HTG Series Accessories for High-temperature Gages

Name	Models	Specifications	Qty
High-temperature solder	HTG-S-B	Fusion temperature: 309°C Maximum operating temperature: 300°C	40 cm long bar x 2
Flux for high-temperature solder	HTG-S-F	Ingredients: Inorganic acid + alcohol	20 g
Heat-resistant glass tube	HTG-G-TUBE	Inner diameter: 1.5 mm Length: 1 m	10 pcs
Heat-resistant teflon tape	HTG-T-TAPE	Heat resistance: 200°C Width: 12.7 mm	32.9 m long
Heat-resistant glass tape	HTG-G-TAPE	Heat resistance: 350°C Width: 25 mm	33 m long

*The heat resistance of 350°C for the heat-resistant glass tape is the specification for a short-term operation.

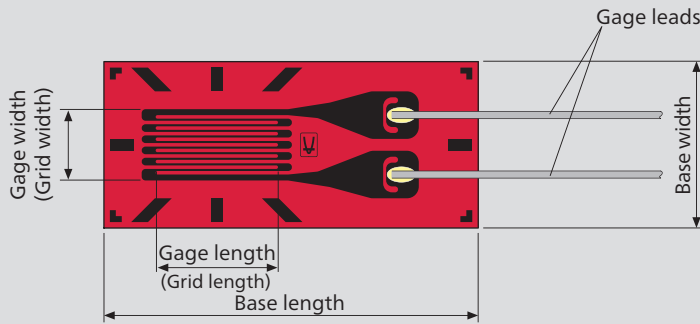

● Gage Factor	Approx. 2.1
● Applicable Linear Expansion Coefficients ($\times 10^{-6}/^{\circ}\text{C}$)	5, 11, 16, 23, 27
● Self-temperature-compensation Range	10 to 100°C

Applicable Adhesives and Operating Temperature

CC-33A: -196 to 120°C	EP-340: -55 to 150°C
CC-35: -30 to 120°C	PC-600: -196 to 150°C
CC-36: -30 to 100°C	

Typical characteristic curve of thermally-induced apparent strain with KFGS gages

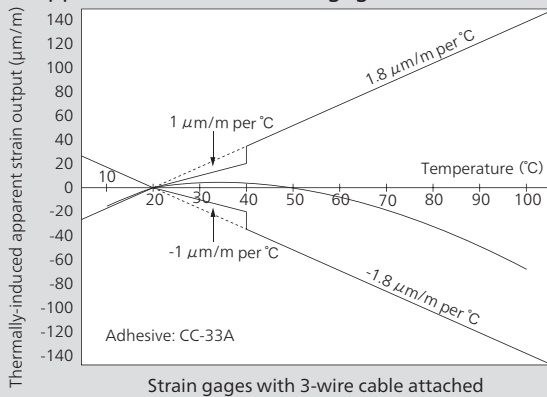

General-purpose Foil Strain Gages

RoHS

The KFGS series gages use polyimide resin for the base that is approx. $13\ \mu\text{m}$ thick. It ensures excellent flexibility. The outstanding moisture proof enables the KFGS gages to operate effectively both indoors and outdoors. Unless directly exposed to water droplets, no coating treatment is required.

- Various lengths and patterns are available to cope with multiple applications.
- Excellent moisture resistance.
- The thin gage base provides less resiliency, and thus ensures excellent workability and easy bonding to curved surfaces.
- Compensated temperature range is as wide as 10 to 100°C and thermal effect in a range of 20 to 40°C is as small as $\pm 1\ \mu\text{m}/\text{m}/^{\circ}\text{C}$ (representative value).
- Strain limit at room temperatures is approximately 5% and fatigue life is 1.2×10^7 times (uniaxial gages), making them suitable for material tests.
- For gages with a 2-wire cable, the resistance and the gage factor are as stated including the lead-wire cables.
- For gages with a 3-wire cable, the gage factor is as stated including the lead-wire cables but the stated resistance does not include the effect of the lead-wire cables.

Types, lengths and codes of lead-wire cables pre-attached to KFGS series gages

Type	2 polyester-coated copper wires	3 polyester-coated copper wires	Vinyl-coated flat 2-wire cables		Vinyl-coated flat 3-wire cables		Mid-temperature 2-wire cables	Mid-temperature 3-wire cables
	C1, C2, C3, C15, C16, D1, D2, D3, D4, D6, D9, D16, D17, D19, D28, D31, D39	C1, C2, C3, C15, C16, D1, D4, D9, D16, D17, D19, D28, D39	C1, C2, C3, C15, C16, D9, D19	D1, D4, D16, D17, D28, D39	C1, C2, C3, C15, C16, D2, D9, D19, D31	D1, D4, D16, D17, D28, D39	C1, C2, C3, C15, C16, D1, D4, D9, D16, D17, D19, D28, D39	C1, C2, C3, C15, C16, D1, D2, D4, D9, D16, D17, D19, D28, D31, D39
Length								
15 cm	N15C2	N15C3	L15C2R	L15C2S	L15C3R	L15C3S	R15C2	R15C3
30 cm	N30C2	N30C3	L30C2R	L30C2S	L30C3R	L30C3S	R30C2	R30C3
1 m	N1M2	N1M3	L1M2R	L1M2S	L1M3R	L1M3S	R1M2	R1M3
3 m	—	—	L3M2R	L3M2S	L3M3R	L3M3S	R3M2	R3M3
5 m	—	—	L5M2R	L5M2S	L5M3R	L5M3S	R5M2	R5M3
Operating temp.	-196 to 150°C		-10 to 80°C				-100 to 150°C	
Remarks	Twisted for $\geq 50\ \text{cm}$ (There are exceptions.)		L-6 L-9 for $\geq 6\ \text{m}$		L-7 L-10 for $\geq 6\ \text{m}$		L-11*	L-12*

* For type R of lead-wire cable with glass-cloth tape, see page 23.

** For other lead-wire cable lengths, contact us.

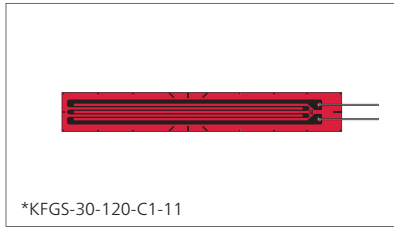

*KFGS-30-120-C1-11

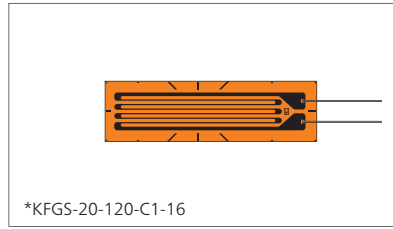

*KFGS-20-120-C1-16

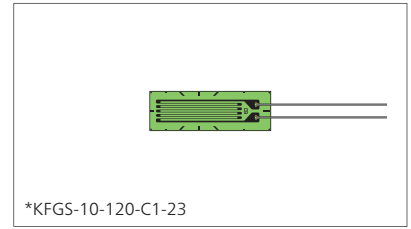

*KFGS-10-120-C1-23

Models	KFGS-30-120-C1-	11 16 23 27	KFGS-20-120-C1-	11 16 23 27	KFGS-10-120-C1-	11 16 23 27
Pattern	Uniaxial		Uniaxial		Uniaxial	
Base	37 × 5.2 mm		28 × 8 mm		16 × 5.2 mm	
Gage (Grid)	30 × 3.3 mm		20 × 5 mm		10 × 3 mm	
Resistance	120 Ω		120 Ω		120 Ω	
Pieces per Pack	10		10		10	

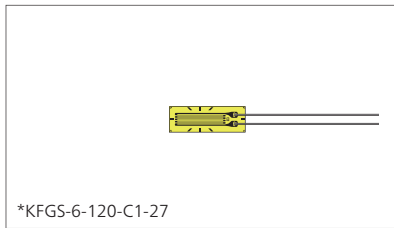

*KFGS-6-120-C1-27

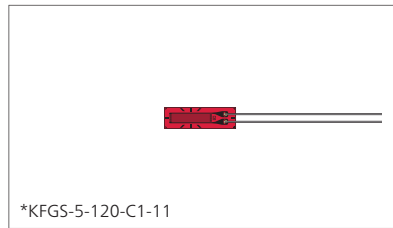

*KFGS-5-120-C1-11

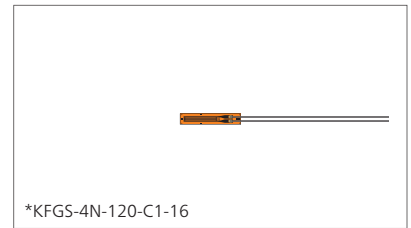

*KFGS-4N-120-C1-16

Models	KFGS-6-120-C1-	11 16 23 27	KFGS-5-120-C1-	5 11 16 23 27	KFGS-4N-120-C1-	11 16 23 27
Pattern	Uniaxial		Uniaxial		Uniaxial	
Base	10 × 3.4 mm		9.4 × 2.8 mm		8 × 1.4 mm	
Gage (Grid)	6 × 1.7 mm		5 × 1.4 mm		4 × 0.7 mm	
Resistance	120 Ω		120 Ω		120 Ω	
Pieces per Pack	10		10		10	

When ordering, specify the model number as follows.

KFGS-□-120-C1-□ Lead-wire Cable Code

(e.g.)

KFGS-30-120-C1-11 L1M3R

*Values in □ and lead-wire cable code cannot be arbitrarily combined.

Lead-wire Cable Type and Shape	Oprg. Temp.	Length	Code
Vinyl-coated flat 3-wire cable L-7 (L-10 for 6 m or longer)	-10 to 80°C	1 m	L1M3R
		3 m	L3M3R
		5 m	L5M3R
Vinyl-coated flat 2-wire cable L-6 (L-9 for 6 m or longer)	-10 to 80°C	1 m	L1M2R
		3 m	L3M2R
		5 m	L5M2R
Mid-temperature 3-wire cable L-12	-100 to 150°C	1 m	R1M3
		3 m	R3M3
		5 m	R5M3
Mid-temperature 2-wire cable L-11	-100 to 150°C	1 m	R1M2
		3 m	R3M2
		5 m	R5M2
3 polyester-coated copper wires	-196 to 150°C	30 cm	N30C3
		50 cm, 1 m	N50C3
		1 m	N1M3
2 polyester-coated copper wires	-196 to 150°C	30 cm	N30C2
		50 cm	N50C2
		1 m	N1M2
Silver-covered copper wires	-196 to 150°C	25 mm	

*Gage (Grid): Length × Width

Oprg. Temp.: Operating Temperature

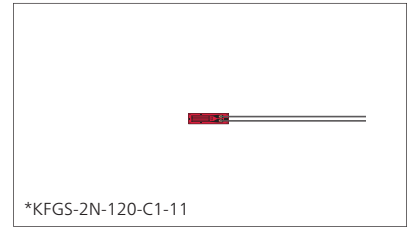
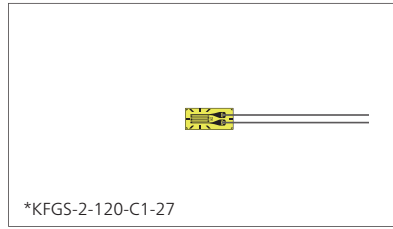
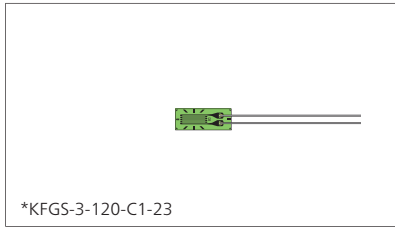

Models	KFGS-3-120-C1-	11	KFGS-2-120-C1-	5	KFGS-2N-120-C1-	11
		16		11		16
		23		16		23
		27		23		27
Pattern	Uniaxial		Uniaxial		Uniaxial	
Base	7.4 × 2.8 mm		6.3 × 2.8 mm		5.3 × 1.4 mm	
Gage (Grid)	3 × 1.3 mm		2 × 1.2 mm		2 × 0.84 mm	
Resistance	120 Ω		120 Ω		120 Ω	
Pieces per Pack	10		10		10	

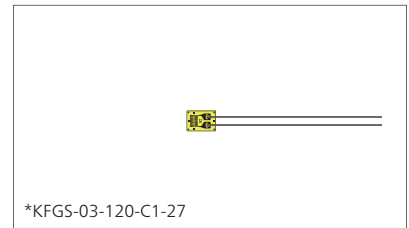
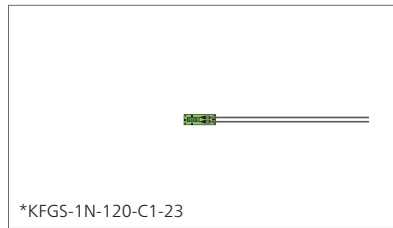
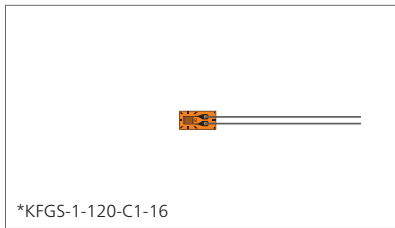

Models	KFGS-1-120-C1-	11	KFGS-1N-120-C1-	11	KFGS-03-120-C1-	11
		16		16		16
		23		23		23
		27		27		27
Pattern	Uniaxial		Uniaxial		Uniaxial	
Base	4.8 × 2.4 mm		4.2 × 1.4 mm		3.5 × 2.4 mm	
Gage (Grid)	1 × 1.1 mm		1 × 0.65 mm		0.3 × 1.4 mm	
Resistance	120 Ω		120 Ω		120 Ω	
Pieces per Pack	10		10		10	

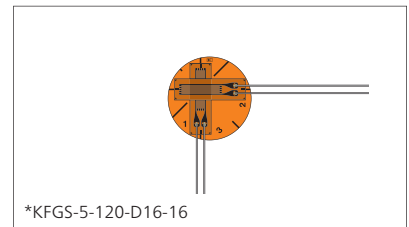
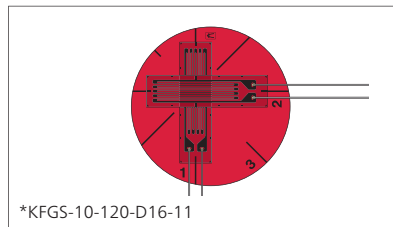
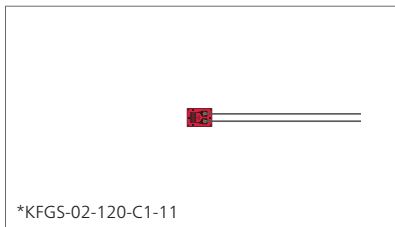

Models	KFGS-02-120-C1-	11	KFGS-10-120-D16-	11	KFGS-5-120-D16-	11
		16		16		16
		23		23		23
		27		27		27
Pattern	Uniaxial		Biaxial, 0°/90° stacked rosette		Biaxial, 0°/90° stacked rosette	
Base	3.3 × 2.4 mm		φ21		φ11	
Gage (Grid)	0.2 × 1.4 mm		10 × 3 mm		5 × 1.4 mm	
Resistance	120 Ω		120 Ω		120 Ω	
Pieces per Pack	10		10		10	

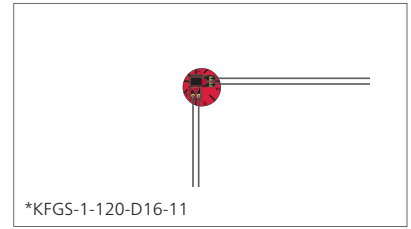
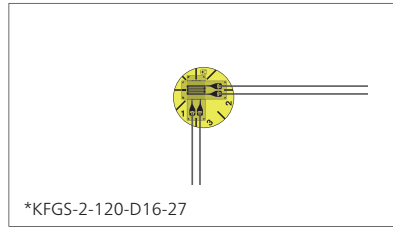
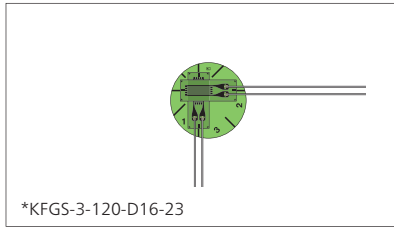

Models	KFGS-3-120-D16-	11 16 23 27	KFGS-2-120-D16-	11 16 23 27	KFGS-1-120-D16-	11 16 23 27
Pattern	Biaxial, 0°/90° stacked rosette		Biaxial, 0°/90° stacked rosette		Biaxial, 0°/90° stacked rosette	
Base	φ10		φ8		φ5	
Gage (Grid)	3 × 1.3 mm		2 × 1.2 mm		1 × 1.1 mm	
Resistance	120 Ω		120 Ω		120 Ω	
Pieces per Pack	10		10		10	







When ordering, specify the model number as follows.

KFGS-□-120-□-□ Lead-wire Cable Code

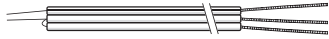
e.g.

KFGS-1-120-D16-11 L1M3S

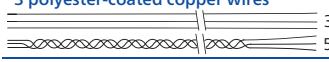
*Values in □ and lead-wire cable code cannot be arbitrarily combined.

Lead-wire Cable Type and Shape	Oprg. Temp.	Length	Code
Vinyl-coated flat 3-wire cable L-7 (L-10 for 6 m or longer) 	-10 to 80°C	1 m	L1M3R:L1M3S
		3 m	L3M3R:L3M3S
		5 m	L5M3R:L5M3S
Vinyl-coated flat 2-wire cable L-6 (L-9 for 6 m or longer) 	-10 to 80°C	1 m	L1M2R:L1M2S
		3 m	L3M2R:L3M2S
		5 m	L5M2R:L5M2S
Mid-temperature 3-wire cable L-12 	-100 to 150°C	1 m	R1M3
		3 m	R3M3
		5 m	R5M3
Mid-temperature 2-wire cable L-11 	-100 to 150°C	1 m	R1M2
		3 m	R3M2
		5 m	R5M2
3 polyester-coated copper wires 	-196 to 150°C	30 cm	N30C3
		50 cm, 1 m	N50C3
		1 m	N1M3
2 polyester-coated copper wires 	-196 to 150°C	30 cm	N30C2
		50 cm	N50C2
		1 m	N1M2
Silver-covered copper wires 	-196 to 150°C	25 mm	

*Gage (Grid): Length × Width

KFGS ● Triaxial, Biaxial, Biaxial for Torque Measurement

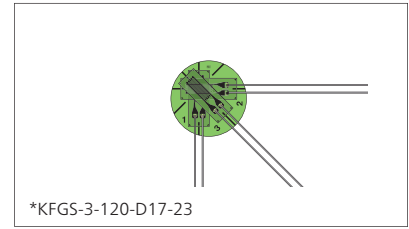
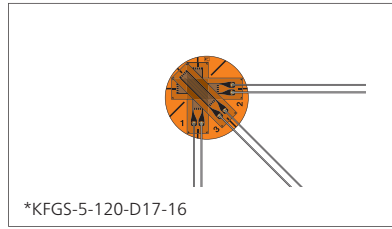
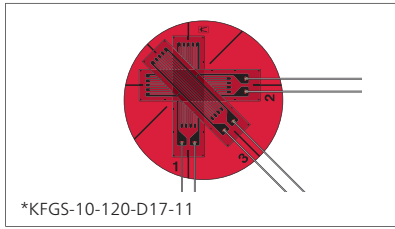

Models	KFGS-10-120-D17-	11 16 23 27	KFGS-5-120-D17-	11 16 23 27	KFGS-3-120-D17-	11 16 23 27
Pattern	Triaxial, 0°/90°/45° stacked rosette for stress analysis		Triaxial, 0°/90°/45° stacked rosette for stress analysis		Triaxial, 0°/90°/45° stacked rosette for stress analysis	
Base	φ21		φ11		φ10	
Gage (Grid)	10 × 3 mm		5 × 1.4 mm		3 × 1.3 mm	
Resistance	120 Ω		120 Ω		120 Ω	
Pieces per Pack	10		10		10	

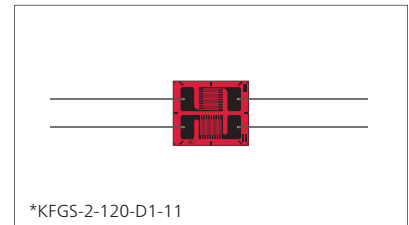
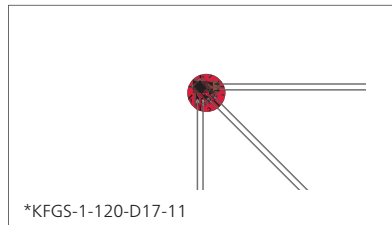
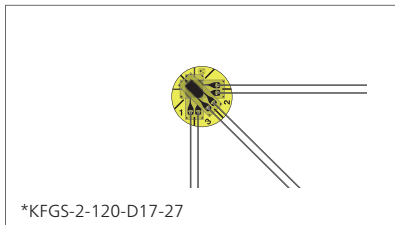

Models	KFGS-2-120-D17-	11 16 23 27	KFGS-1-120-D17-	11 16 23 27	KFGS-2-120-D1-	11 16 23 27
Pattern	Triaxial, 0°/90°/45° stacked rosette for stress analysis		Triaxial, 0°/90°/45° stacked rosette for stress analysis		Biaxial, 0°/90° plane arrangement	
Base	φ8		φ5		10 × 8.5 mm	
Gage (Grid)	2 × 1.2 mm		1 × 1.1 mm		2 × 3.2 mm	
Resistance	120 Ω		120 Ω		120 Ω	
Pieces per Pack	10		10		10	

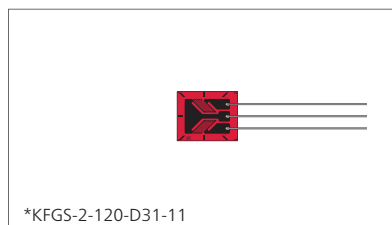
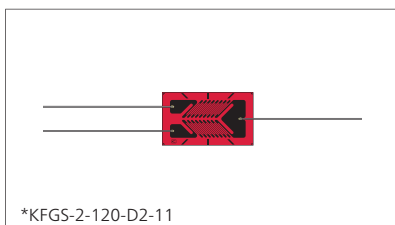

Models	KFGS-2-120-D2-	11 16 23 27	KFGS-2-120-D31-	11 16 23 27
Pattern	Biaxial, 0°/90° plane arrangement for torque measurement		Biaxial, 0°/90° plane arrangement for torque measurement	
Base	12 × 7 mm		8 × 6.5 mm	
Gage (Grid)	2 × 3.4 mm		2 × 1.2 mm	
Resistance	120 Ω		120 Ω	
Pieces per Pack	10		10	

KFGS ● Triaxial, Quadraaxial, Uniaxial with gage leads at both ends

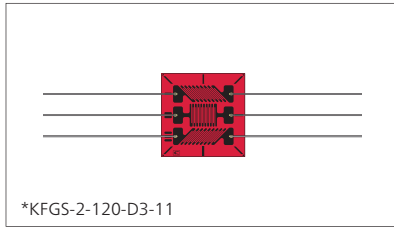

*KFGS-2-120-D3-11

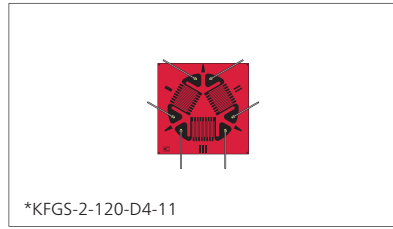

*KFGS-2-120-D4-11

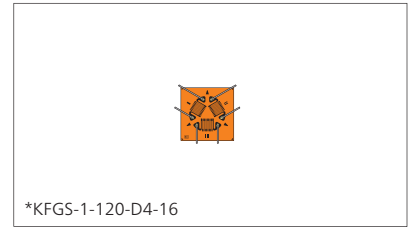

*KFGS-1-120-D4-16

Models	KFGS-2-120-D3-	11 16 23 27	KFGS-2-120-D4-	11 16 23 27	KFGS-1-120-D4-	11 16 23 27
Pattern	Triaxial, 0°/90°/45° plane arrangement		Triaxial, 0°/120°/240° plane arrangement		Triaxial, 0°/120°/240° plane arrangement	
Base	11 × 11 mm		12 × 12 mm		7 × 7 mm	
Gage (Grid)	2 × 3.6 mm		2 × 3.4 mm		1 × 1.7 mm	
Resistance	120 Ω		120 Ω		120 Ω	
Pieces per Pack	10		10		10	

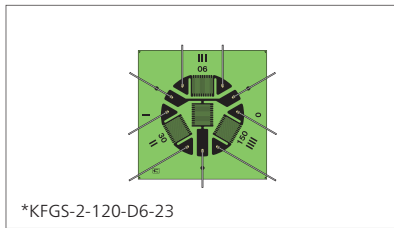

*KFGS-2-120-D6-23

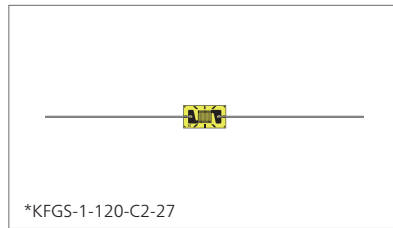

*KFGS-1-120-C2-27

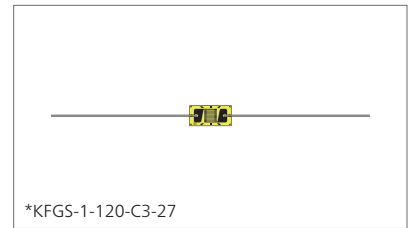

*KFGS-1-120-C3-27

Models	KFGS-2-120-D6-	11 16 23 27	KFGS-1-120-C2-	11 16 23 27	KFGS-1-120-C3-	11 16 23 27
Pattern	Quadraaxial, 0°/30°/90°/150° plane arrangement		Uniaxial, gage leads at both ends		Uniaxial, gage leads at both ends	
Base	17 × 17 mm		5.6 × 3 mm		5.5 × 2.7 mm	
Gage (Grid)	2 × 3.1 mm		1 × 1.8 mm		1 × 1.8 mm	
Resistance	120 Ω		120 Ω		120 Ω	
Pieces per Pack	10		10		10	

When ordering, specify the model number as follows.

KFGS-□-120-□-□ Lead-wire Cable Code

(e.g.)

KFGS-1-120-C3-11 L1M3R

*Values in □ and lead-wire cable code cannot be arbitrarily combined.

Lead-wire Cable Type and Shape	Oprg. Temp.	Length	Code
Vinyl-coated flat 3-wire cable L-7 (L-10 for 6 m or longer)	-10 to 80°C	1 m	L1M3R:L1M3S
		3 m	L3M3R:L3M3S
		5 m	L5M3R:L5M3S
Vinyl-coated flat 2-wire cable L-6 (L-9 for 6 m or longer)	-10 to 80°C	1 m	L1M2R:L1M2S
		3 m	L3M2R:L3M2S
		5 m	L5M2R:L5M2S
Mid-temperature 3-wire cable L-12	-100 to 150°C	1 m	R1M3
		3 m	R3M3
		5 m	R5M3
Mid-temperature 2-wire cable L-11	-100 to 150°C	1 m	R1M2
		3 m	R3M2
		5 m	R5M2
3 polyester-coated copper wires	-196 to 150°C	30 cm	N30C3
		50 cm, 1 m	N50C3
		1 m	N1M3
2 polyester-coated copper wires	-196 to 150°C	30 cm	N30C2
		50 cm, 1 m	N50C2
		1 m	N1M2
Silver-covered copper wires	-196 to 150°C	25 mm	

*Gage (Grid): Length × Width

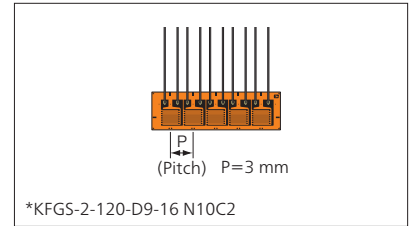
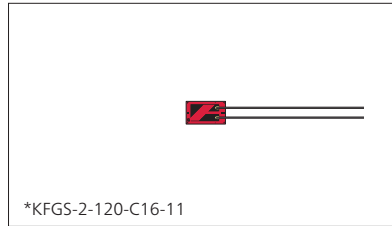
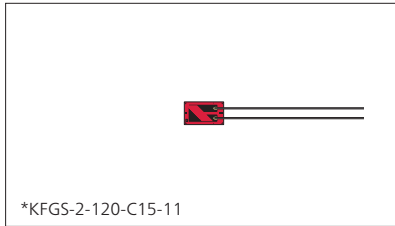

Models	KFGS-2-120-C15-	11
		16
		23
		27
	(Torque measurement possible in combination with C16)	
Pattern	Uniaxial, for shearing strain measurement	
Base	5.2 × 3 mm	
Gage (Grid)	2 × 0.8 mm	
Resistance	120 Ω	
Pieces per Pack	10	

Models	KFGS-2-120-C16-	11
		16
		23
		27
	(Torque measurement possible in combination with C15)	
Pattern	Uniaxial, for shearing strain measurement	
Base	5.2 × 3 mm	
Gage (Grid)	2 × 0.8 mm	
Resistance	120 Ω	
Pieces per Pack	10	

Models	KFGS-2-120-D9-	11
		16
		23
		27
	(Pre-attached type: 2 polyester-coated copper wires (10 cm) + the specified lead-wire cable)	
Pattern	Uniaxial 5-element, for concentrated stress measurement	
Base	17 × 5 mm	
Gage (Grid)	2 × 2.2 mm	
Resistance	120 Ω	
Pieces per Pack	5	

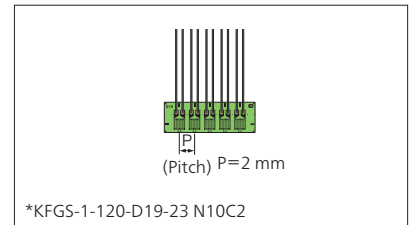
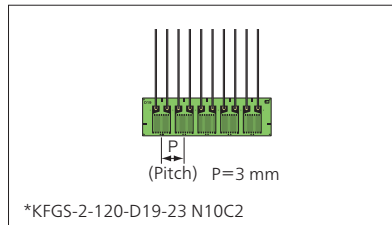
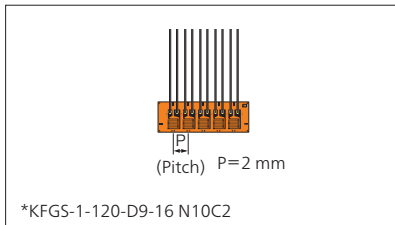

Models	KFGS-1-120-D9-	11
		16
		23
		27
	(Pre-attached type: 2 polyester-coated copper wires (10 cm) + the specified lead-wire cable)	
Pattern	Uniaxial 5-element, stacked rosette for concentrated stress measurement	
Base	12 × 4 mm	
Gage (Grid)	1 × 1.4 mm	
Resistance	120 Ω	
Pieces per Pack	5	

Models	KFGS-2-120-D19-	11
		16
		23
		27
	(Pre-attached type: 2 polyester-coated copper wires (10 cm) + the specified lead-wire cable)	
Pattern	Uniaxial 5-element, for concentrated stress measurement	
Base	17 × 5 mm	
Gage (Grid)	2 × 2.5 mm	
Resistance	120 Ω	
Pieces per Pack	5	

Models	KFGS-1-120-D19-	11
		16
		23
		27
	(Pre-attached type: 2 polyester-coated copper wires (10 cm) + the specified lead-wire cable)	
Pattern	Uniaxial 5-element, for concentrated stress measurement	
Base	12 × 4 mm	
Gage (Grid)	1 × 1.5 mm	
Resistance	120 Ω	
Pieces per Pack	5	

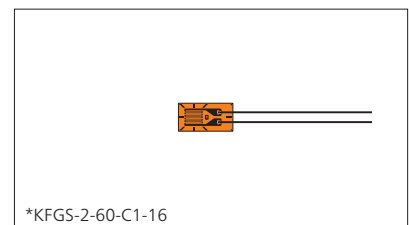
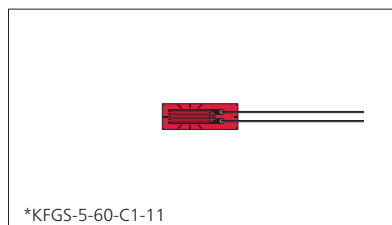
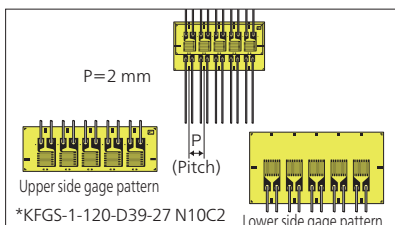

Models	KFGS-1-120-D39-	11
		16
		23
		27
	(Pre-attached type: 2 polyester-coated copper wires (10 cm) + the specified lead-wire cable)	
Pattern	Biaxial 5-element, stacked rosette for concentrated stress measurement	
Base	12 × 6.4 mm	
Gage (Grid)	1 × 1.4 (1.5) mm * () indicates lower side gage.	
Resistance	120 Ω	
Pieces per Pack	5	

Models	KFGS-5-60-C1-	11
		16
		23
		27
	(Use 2 gages in series connection)	
Pattern	Uniaxial	
Base	10 × 3.4 mm	
Gage (Grid)	5 × 2 mm	
Resistance	60 Ω	
Pieces per Pack	10	

Models	KFGS-2-60-C1-	11
		16
		23
		27
	(Use 2 gages in series connection)	
Pattern	Uniaxial	
Base	7.2 × 3.7 mm	
Gage (Grid)	2 × 2.3 mm	
Resistance	60 Ω	
Pieces per Pack	10	

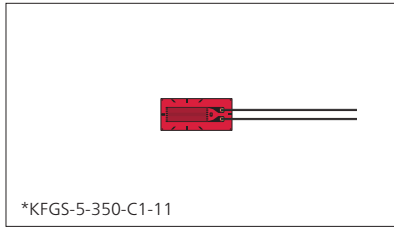

*KFGS-5-350-C1-11

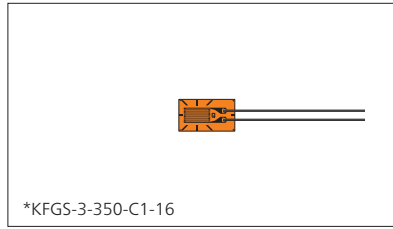

*KFGS-3-350-C1-16

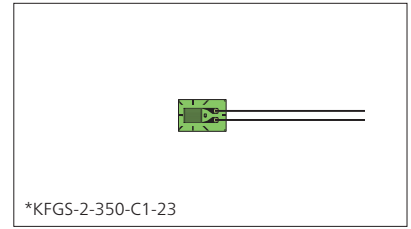

*KFGS-2-350-C1-23

Models	KFGS-5-350-C1-	11 16 23 27	KFGS-3-350-C1-	11 16 23 27	KFGS-2-350-C1-	11 16 23 27
Pattern	Uniaxial		Uniaxial		Uniaxial	
Base	9.4 × 4.2 mm		7.4 × 4.2 mm		6.3 × 4.2 mm	
Gage (Grid)	5 × 2 mm		3 × 2 mm		2 × 2 mm	
Resistance	350 Ω		350 Ω		350 Ω	
Pieces per Pack	10		10		10	

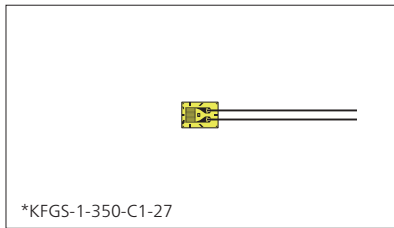

*KFGS-1-350-C1-27

Models	KFGS-1-350-C1-	11 16 23 27
Pattern	Uniaxial	
Base	4.8 × 3.4 mm	
Gage (Grid)	1 × 2 mm	
Resistance	350 Ω	
Pieces per Pack	10	

When ordering, specify the model number as follows.

KFGS-□-350-□-□ Lead-wire Cable Code

(e.g.)

KFGS-1-350-C1-11 L1M3R

*Values in □ and lead-wire cable code cannot be arbitrarily combined.

Lead-wire Cable Type and Shape	Oprg. Temp.	Length	Code
Vinyl-coated flat 3-wire cable L-7 (L-10 for 6 m or longer)	-10 to 80°C	1 m	L1M3R
		3 m	L3M3R
		5 m	L5M3R
Vinyl-coated flat 2-wire cable L-6 (L-9 for 6 m or longer)	-10 to 80°C	1 m	L1M2R
		3 m	L3M2R
		5 m	L5M2R
Mid-temperature 3-wire cable L-12	-100 to 150°C	1 m	R1M3
		3 m	R3M3
		5 m	R5M3
Mid-temperature 2-wire cable L-11	-100 to 150°C	1 m	R1M2
		3 m	R3M2
		5 m	R5M2
3 polyester-coated copper wires	-196 to 150°C	30 cm	N30C3
		50 cm	N50C3
		50 cm, 1 m	N1M3
		10 cm	N10C2
2 polyester-coated copper wires	-196 to 150°C	30 cm	N30C2
		50 cm	N50C2
		50 cm, 1 m	N1M2
		25 mm	
Silver-covered copper wires	-196 to 150°C	25 mm	

*Gage (Grid): Length × Width

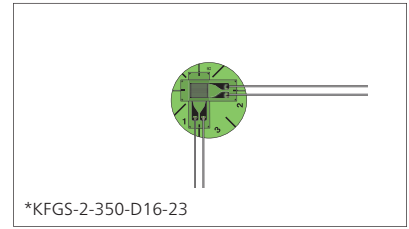
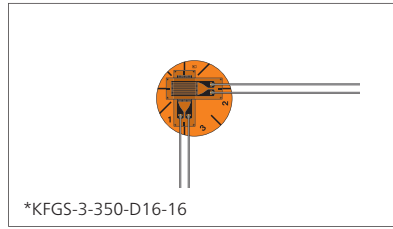
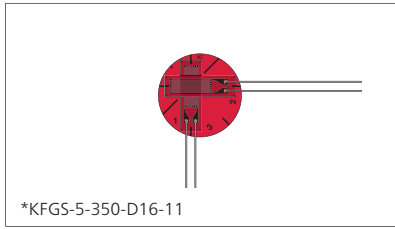

Models	KFGS-5-350-D16-	11 16 23 27	KFGS-3-350-D16-	11 16 23 27	KFGS-2-350-D16-	11 16 23 27
Pattern	Biaxial, 0°/90° stacked rosette		Biaxial, 0°/90° stacked rosette		Biaxial, 0°/90° stacked rosette	
Base	φ11		φ10		φ10	
Gage (Grid)	5 × 2 mm		3 × 2 mm		2 × 2 mm	
Resistance	350 Ω		350 Ω		350 Ω	
Pieces per Pack	10		10		10	

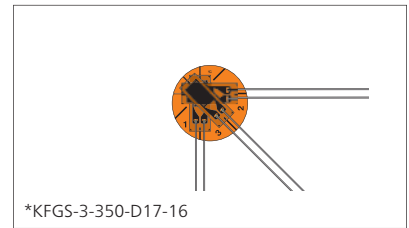
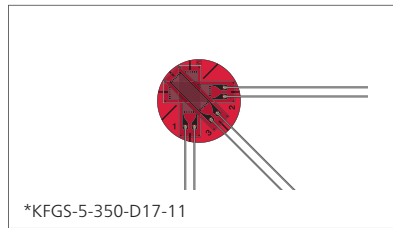
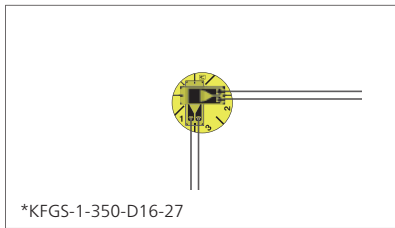

Models	KFGS-1-350-D16-	11 16 23 27	KFGS-5-350-D17-	11 16 23 27	KFGS-3-350-D17-	11 16 23 27
Pattern	Biaxial, 0°/90° stacked rosette		Triaxial, 0°/90°/45° stacked rosette for stress analysis		Triaxial, 0°/90°/45° stacked rosette for stress analysis	
Base	φ8		φ11		φ10	
Gage (Grid)	1 × 1.8 mm		5 × 2 mm		3 × 2 mm	
Resistance	350 Ω		350 Ω		350 Ω	
Pieces per Pack	10		10		10	

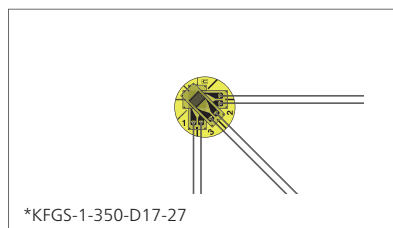
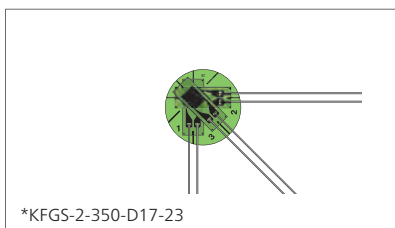

Models	KFGS-2-350-D17-	11 16 23 27	KFGS-1-350-D17-	11 16 23 27
Pattern	Triaxial, 0°/90°/45° stacked rosette for stress analysis		Triaxial, 0°/90°/45° stacked rosette for stress analysis	
Base	φ10		φ8	
Gage (Grid)	2 × 2 mm		1 × 1.8 mm	
Resistance	350 Ω		350 Ω	
Pieces per Pack	10		10	

KFGS ● Biaxial, Biaxial for torque measurement

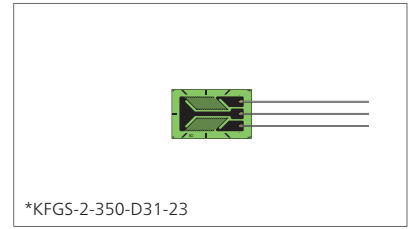
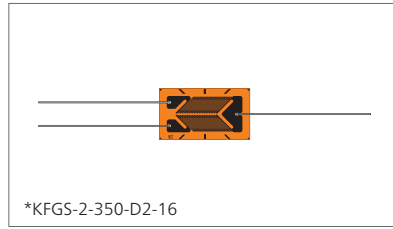
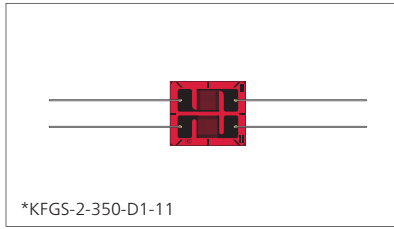

Models	KFGS-2-350-D1-	11 16 23 27	KFGS-2-350-D2-	11 16 23 27	KFGS-2-350-D31-	11 16 23 27
Pattern	Biaxial, 0°/90° plane arrangement		Biaxial, 0°/90° plane arrangement for torque measurement		Biaxial, 0°/90° plane arrangement for torque measurement	
Base	10 × 8.5 mm		12 × 6.8 mm		10.5 × 6.5 mm	
Gage (Grid)	2 × 3 mm		2 × 4 mm		2 × 3 mm	
Resistance	350 Ω		350 Ω		350 Ω	
Pieces per Pack	10		10		10	

When ordering, specify the model number as follows.

KFGS-□-350-□-□ Lead-wire Cable Code

(e.g.)

KFGS-2-350-D17-11 L1M3S

*Values in □ and lead-wire cable code cannot be arbitrarily combined.

Lead-wire Cable Type and Shape	Oprg. Temp.	Length	Code
Vinyl-coated flat 3-wire cable L-7 (L-10 for 6 m or longer) 	-10 to 80°C	1 m	L1M3R:L1M3S
		3 m	L3M3R:L3M3S
		5 m	L5M3R:L5M3S
Vinyl-coated flat 2-wire cable L-6 (L-9 for 6 m or longer) 	-10 to 80°C	1 m	L1M2R:L1M2S
		3 m	L3M2R:L3M2S
		5 m	L5M2R:L5M2S
Mid-temperature 3-wire cable L-12 	-100 to 150°C	1 m	R1M3
		3 m	R3M3
		5 m	R5M3
Mid-temperature 2-wire cable L-11 	-100 to 150°C	1 m	R1M2
		3 m	R3M2
		5 m	R5M2
3 polyester-coated copper wires 	-196 to 150°C	30 cm	N30C3
		50 cm, 1 m	N50C3
		1 m	N1M3
2 polyester-coated copper wires 	-196 to 150°C	10 cm	N10C2
		30 cm	N30C2
		50 cm	N50C2
		1 m	N1M2
Silver-covered copper wires 	-196 to 150°C	25 mm	

*Gage (Grid): Length × Width

KFGS ● Uniaxial for transducers

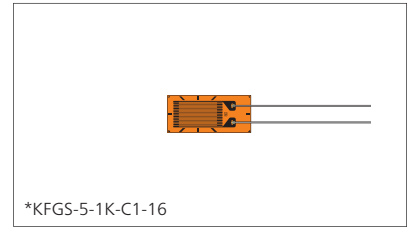
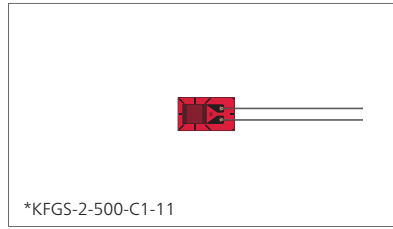
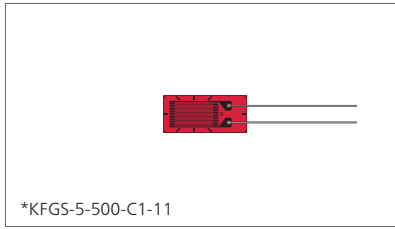

Models	KFGS-5-500-C1-	11	KFGS-2-500-C1-	11	KFGS-5-1K-C1-	11
		16		16		16
		23		23		23
		27		27		27
Pattern	Uniaxial, for transducers		Uniaxial, for transducers		Uniaxial, for transducers	
Base	11 × 4.9 mm		7.5 × 4.4 mm		11 × 4.9 mm	
Gage (Grid)	5 × 3.5 mm		2 × 2.6 mm		5 × 3.5 mm	
Resistance	500 Ω		500 Ω		1000 Ω	
Pieces per Pack	10		10		10	

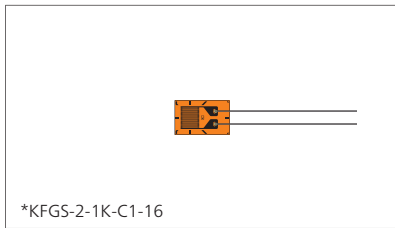

Models	KFGS-2-1K-C1-	11
		16
		23
		27
Pattern	Uniaxial, for transducers	
Base	7.2 × 4.5 mm	
Gage (Grid)	2 × 3 mm	
Resistance	1000 Ω	
Pieces per Pack	10	

When ordering, specify the model number as follows.

KFGS-□-□-C1-□ Lead-wire Cable Code

(e.g.)

KFGS-2-1K-C1-11 L1M3R

*Values in □ and lead-wire cable code cannot be arbitrarily combined.

Lead-wire Cable Type and Shape	Oprg. Temp.	Length	Code
Vinyl-coated flat 3-wire cable L-7 (L-10 for 6 m or longer)	-10 to 80°C	1 m	L1M3R
		3 m	L3M3R
		5 m	L5M3R
Vinyl-coated flat 2-wire cable L-6 (L-9 for 6 m or longer)	-10 to 80°C	1 m	L1M2R
		3 m	L3M2R
		5 m	L5M2R
Mid-temperature 3-wire cable L-12	-100 to 150°C	1 m	R1M3
		3 m	R3M3
		5 m	R5M3
Mid-temperature 2-wire cable L-11	-100 to 150°C	1 m	R1M2
		3 m	R3M2
		5 m	R5M2
3 polyester-coated copper wires	-196 to 150°C	30 cm	N30C3
		50 cm, 1 m	N50C3
		1 m	N1M3
2 polyester-coated copper wires	-196 to 150°C	30 cm	N30C2
		50 cm	N50C2
		1 m	N1M2
Silver-covered copper wires	-196 to 150°C	25 mm	

*Gage (Grid): Length × Width

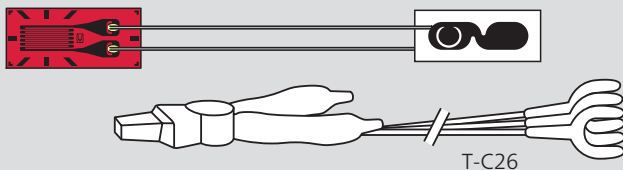

(When the clip-equipped dedicated cable is used, the operating temperature range of each adhesive after curing is -10 to 80°C.)

● Gage Factor	Approx. 2.1
● Applicable Linear Expansion Coefficients (x10 ⁻⁶ /°C)	11, 16, 23
● Self-temperature-compensation Range	10 to 100°C

Applicable Adhesives and Operating Temperature Ranges

CC-33A:	-196 to 120°C
CC-35:	-30 to 120°C
CC-36:	-30 to 100°C
EP-340:	-55 to 120°C

Foil Strain Gages with Gage Terminal

KFGS gages equipped with a gage terminal enable one-touch-connection/disconnection of the lead-wire cable. They are suitable for residual stress measurement with the cutting method. A clip-equipped dedicated cable T-C26 (Vinyl-coated, 2 m long) is optionally available.

Lead-wire Cable Type and Shape	Oprg. Temp.	Length
Polyester-coated copper wires with gage terminal	-196 to 150°C	15 mm

KFGS ● Uniaxial, Biaxial, Triaxial (With gage terminal)

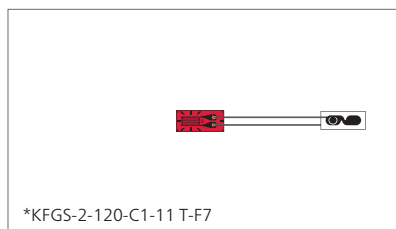

*KFGS-2-120-C1-11 T-F7

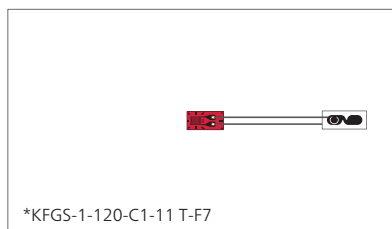

*KFGS-1-120-C1-11 T-F7

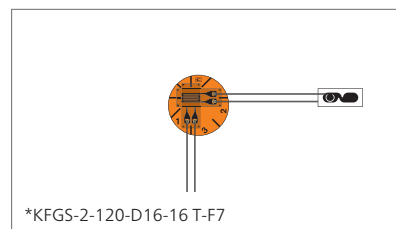

*KFGS-2-120-D16-16 T-F7

Models

KFGS-2-120-C1- 11 T-F7
16
23

KFGS-1-120-C1- 11 T-F7
16
23

KFGS-2-120-D16- 11 T-F7
16
23

Pattern

Uniaxial

Uniaxial

Biaxial, 0°/90° stacked rosette

Base

6.3 × 2.8 mm

4.8 × 2.4 mm

φ8

Gage (Grid)

2 × 1.2 mm

1 × 1.1 mm

2 × 1.2 mm

Resistance

120 Ω

120 Ω

120 Ω

Pieces per Pack

10

10

10

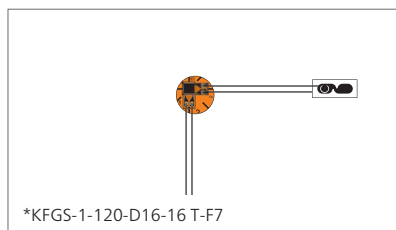

*KFGS-1-120-D16-16 T-F7

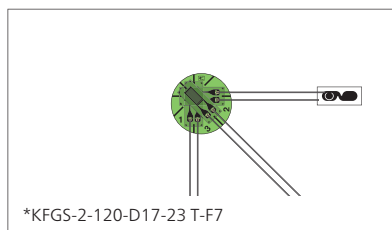

*KFGS-2-120-D17-23 T-F7

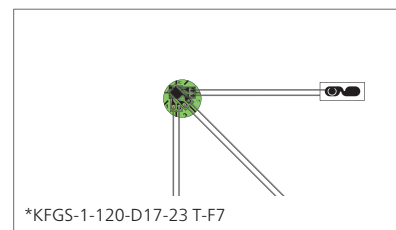

*KFGS-1-120-D17-23 T-F7

Models

KFGS-1-120-D16- 11 T-F7
16
23

KFGS-2-120-D17- 11 T-F7
16
23

KFGS-1-120-D17- 11 T-F7
16
23

Pattern

Biaxial, 0°/90° stacked rosette

Triaxial, 0°/90°/45° stacked rosette

Triaxial, 0°/90°/45° stacked rosette

Base

φ5

φ8

φ5

Gage (Grid)

1 × 1.1 mm

2 × 1.2 mm

1 × 1.1 mm

Resistance

120 Ω

120 Ω

120 Ω

Pieces per Pack

10

10

10

● Gage Factor	Approx. 2.1
● Applicable Linear Expansion Coefficients ($\times 10^{-6}/^{\circ}\text{C}$)	11, 16, 23, 27
● Self-temperature-compensation Range	10 to 100°C

Applicable Adhesives and Operating Temperature Ranges

CC-33A:	-196 to 120°C
CC-35:	-30 to 120°C
CC-36:	-30 to 100°C
EP-340:	-55 to 150°C
PC-600:	-196 to 150°C

■ Foil Strain Gages for Boring Method

Designed to measure residual stress released by the boring method.

KFGS ● Triaxial for boring method

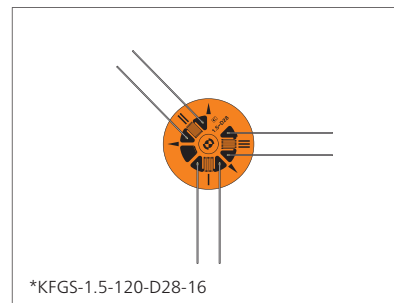
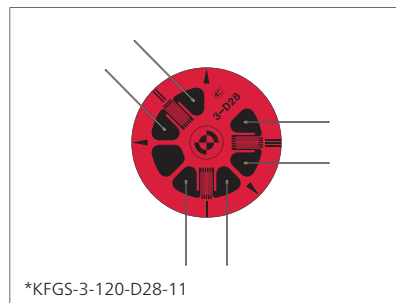

Models	KFGS-3-120-D28-	11 16 23 27
Pattern	Triaxial, 0°/135°/90° plane arrangement	
Base	φ 19.8	
Gage (Grid)	3 × 2 mm	
Resistance	120 Ω	
Pieces per Pack	10	
Gage Center Diameter	φ 10.8	

Models	KFGS-1.5-120-D28-	11 16 23 27
Pattern	Triaxial, 0°/135°/90° plane arrangement	
Base	φ 12	
Gage (Grid)	1.5 × 1.3 mm	
Resistance	120 Ω	
Pieces per Pack	10	
Gage Center Diameter	φ 5.5	

When ordering, specify the model number as follows.

KFGS-□-120-D28-□ Lead-wire Cable Code

(e.g.)

KFGS-3-120-D28-11 L1M3S

*Values in □ and lead-wire cable code cannot be arbitrarily combined.

Lead-wire Cable Type and Shape	Oprg. Temp.	Length	Code
Vinyl-coated flat 3-wire cable L-7 (L-10 for 6 m or longer) 	-10 to 80°C	1 m	L1M3S
		3 m	L3M3S
		5 m	L5M3S
Vinyl-coated flat 2-wire cable L-6 (L-9 for 6 m or longer) 	-10 to 80°C	1 m	L1M2S
		3 m	L3M2S
		5 m	L5M2S
Mid-temperature 3-wire cable L-12 	-100 to 150°C	1 m	R1M3
		3 m	R3M3
		5 m	R5M3
Mid-temperature 2-wire cable L-11 	-100 to 150°C	1 m	R1M2
		3 m	R3M2
		5 m	R5M2
2 polyester-coated copper wires 	-196 to 150°C	5 cm	N5C2
		15 cm	N15C2
		30 cm	N30C2
Silver-covered copper wires 	-196 to 150°C	25 mm	

*Gage (Grid): Length × Width

Gages for Measuring Axial Tension of Bolt

KFB

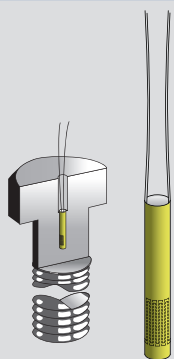

● Gage Factor Approx. 1.9

Applicable Adhesives and Operating Temperature Ranges
EP-370: Normal temperature to 50°C

Strain Gages for Measuring Axial Tension of Bolt

RoHS

If it is difficult to bond a strain gage to the surface of a bolt for measuring the tightening stress, these gages enable measurement by embedding them into a hole, 2 mm diameter, bored through the top head of the bolt.

*We offer service with our sophisticated bonding work of strain gage onto bolts provided by our customers and issue calibration data sheet. For details please contact us.

KFB ● Uniaxial

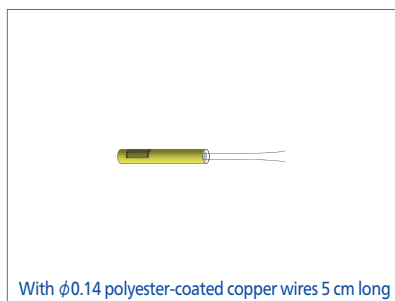

With $\phi 0.14$ polyester-coated copper wires 5 cm long

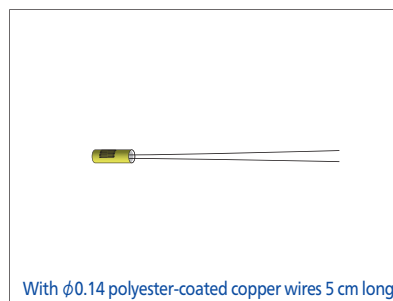

With $\phi 0.14$ polyester-coated copper wires 5 cm long

Models	KFB-3-120-C20-11 N5C2
Pattern	Uniaxial
Base	11.5 × ϕ 1.9 mm
Gage (Grid)	3 × Approx. 6 mm
Resistance	120 Ω
Pieces per Pack	5

Models	KFB-1.5-120-C20-11 N5C2
Pattern	Uniaxial
Base	5 × ϕ 1.9 mm
Gage (Grid)	1.5 × Approx. 6 mm
Resistance	120 Ω
Pieces per Pack	5

Lead-wire Cable Type and Shape	Oprg. Temp.	Length
Polyester-coated copper wires ($\phi 0.14$)	Normal temp. to 50°C	5 cm

*Gage (Grid): Length × Width

Gages for General Stress Measurement

KFGT

RoHS

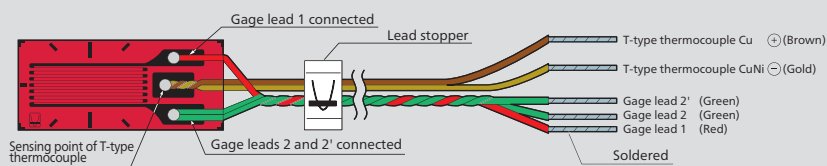

Foil Strain Gages with a Temperature Sensor

The KFGT gages are foil strain gages incorporating a T-type thermocouple for simultaneous measurement of strain and temperature. They ensure efficient strain measurement under environments where temperature change or temperature gradient requires simultaneous measurement of strain and temperature. They also provide highly precise compensation of thermally-induced apparent strain. It is recommended to use Kyowa data logger UCAM-60C M14 and UCAM-65C M14 as a measuring instrument.

● Gage Factor	Approx. 2.1
● Applicable Linear Expansion Coefficients ($\times 10^{-6}/^{\circ}\text{C}$)	11, 16, 23, 27
● Self-temperature-compensation Range	10 to 100°C
● Temperature Sensor	T-type thermocouple
● Accuracy	Within $\pm 1.5^{\circ}\text{C}$

Applicable Adhesives and Operating Temperature Ranges

CC-33A: -10 to 120°C
 CC-35: -10 to 120°C
 CC-36: -10 to 100°C
 EP-340: -10 to 120°C

KFGT ● Uniaxial

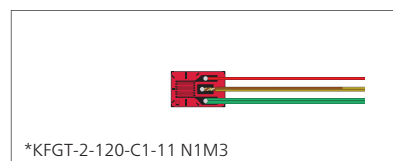
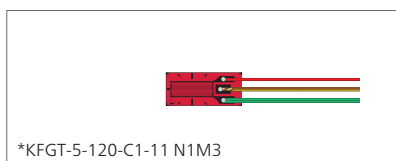

Models	KFGT-5-120-C1- 11 N1M3
	16
	23
	27
Pattern	Uniaxial, 3 wires
Base	10 × 4.5 mm
Gage (Grid)	5 × 2.1 mm
Resistance	120 Ω
Pieces per Pack	5

Models	KFGT-2-120-C1- 11 N1M3
	16
	23
	27
Pattern	Uniaxial, 3 wires
Base	7 × 4.5 mm
Gage (Grid)	2 × 1.8 mm
Resistance	120 Ω
Pieces per Pack	5

Lead-wire Cable Type and Shape	Oprg. Temp.	Length																		
3 polyester-coated copper wires 	-10 to 120°C	1 m																		
Standard accessories Lead-wire stopper to prevent damage to the gage	Optional accessories Extension Lead-wire cables																			
	<table border="1"> <thead> <tr> <th rowspan="2">Model</th> <th colspan="3">Dimensions (mm)</th> <th rowspan="2">Quantity per Pack</th> <th rowspan="2">Remarks</th> </tr> <tr> <th>Length</th> <th>Width</th> <th>Thickness</th> </tr> </thead> <tbody> <tr> <td>NT-1M</td> <td>1000</td> <td rowspan="3">7.2</td> <td rowspan="3">1.2</td> <td rowspan="3">5</td> <td rowspan="3">With gage terminal T-F25</td> </tr> <tr> <td>NT-2M</td> <td>2000</td> </tr> <tr> <td>NT-4M</td> <td>4000</td> </tr> </tbody> </table>	Model	Dimensions (mm)			Quantity per Pack	Remarks	Length	Width	Thickness	NT-1M	1000	7.2	1.2	5	With gage terminal T-F25	NT-2M	2000	NT-4M	4000
Model	Dimensions (mm)			Quantity per Pack	Remarks															
	Length	Width	Thickness																	
NT-1M	1000	7.2	1.2	5	With gage terminal T-F25															
NT-2M	2000																			
NT-4M	4000																			

*Gage (Grid): Length × Width

Gages for General Stress Measurement **KFRB**

RoHS

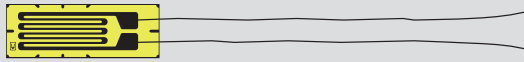

● Gage Factor	Approx. 1.9, 2.0
● Applicable Linear Expansion Coefficients ($\times 10^{-6}/^{\circ}\text{C}$)	11, 16, 23
● Self-temperature-compensation Range	0 to 150°C

Applicable Adhesives and Operating Temperature Ranges

CC-33A: -196 to 120°C
 CC-35: -30 to 120°C
 CC-36: -30 to 100°C
 EP-340: -55 to 150°C
 PC-600: -196 to 150°C

■ Foil Strain Gages

The KFRB series foil strain gages are durable and easy-to-use high-grade strain gages. The gage element is sandwiched between a heat-resistant polyimide base and cover, thereby letting it exhibit high performance in a wide temperature range.

- Highly heat-resistant polyimide resin is used to make them durable.
- A wide compensated temperature range of 0 to 150°C makes them usable under diversified operating conditions.
- The resistive element is made of NiCr alloy foil, thereby ensuring minimal drift under high temperatures and excellent weather and moisture resistances.
- Suitable for incorporation into transducers

■ Types, lengths and codes of lead-wire cables pre-attached to KFRB gages

Type	2 polyester-coated copper wires	3 polyester-coated copper wires	Vinyl-coated flat 2-wire cable		Vinyl-coated flat 3-wire cable		Mid-temperature 2-wire cable	Mid-temperature 3-wire cable
	C1, D25	C1, D25	C1	D25	C1	D25	C1, D25	C1, D25
Length	C1, D25	C1, D25	C1	D25	C1	D25	C1, D25	C1, D25
15 cm	N15C2	N15C3	L15C2R	L15C2S	L15C3R	L15C3S	R15C2	R15C3
30 cm	N30C2	N30C3	L30C2R	L30C2S	L30C3R	L30C3S	R30C2	R30C3
1 m	N1M2	N1M3	L1M2R	L1M2S	L1M3R	L1M3S	R1M2	R1M3
3 m	—	—	L3M2R	L3M2S	L3M3R	L3M3S	R3M2	R3M3
5 m	—	—	L5M2R	L5M2S	L5M3R	L5M3S	R5M2	R5M3
Operating temp.	-196 to 150°C		-10 to 80°C				-100 to 150°C	
Remarks	Twisted for ≥ 50		L-6 L-9 for ≥ 6 m		L-7 L-10 for ≥ 6 m		L-11*	L-12*

* For type R of lead-wire cable with glass-cloth tape, see page 23.

** For other lead-wire cable lengths, contact us.

KFRB ● Uniaxial, Triaxial

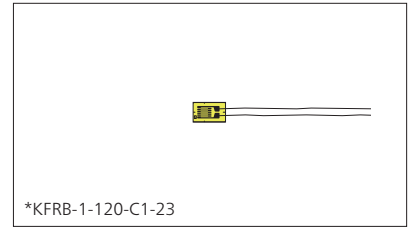
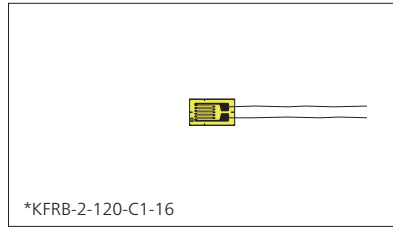
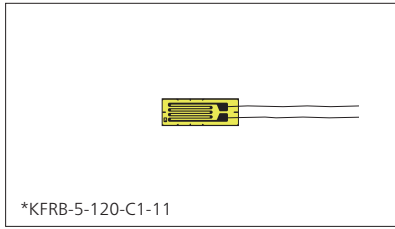

Models	KFRB-5-120-C1-	11 16 23	KFRB-2-120-C1-	11 16 23	KFRB-1-120-C1-	11 16 23
Pattern	Uniaxial		Uniaxial		Uniaxial	
Gage Factor	Approx. 2.0		Approx. 2.0		Approx. 2.0	
Base	10 × 3.7 mm		6 × 3.7 mm		4 × 2.7 mm	
Gage (Grid)	5 × 2.5 mm		2 × 2.5 mm		1 × 1.5 mm	
Resistance	120 Ω		120 Ω		120 Ω	
Pieces per Pack	10		10		10	

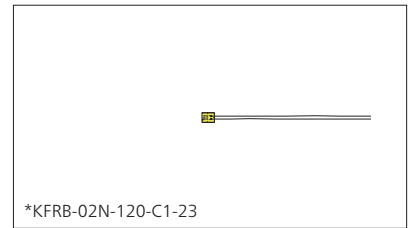
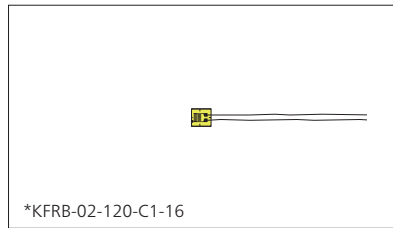
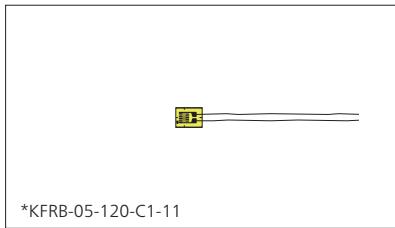

Models	KFRB-05-120-C1-	11 16 23	KFRB-02-120-C1-	11 16 23	KFRB-02N-120-C1-	11 16 23
Pattern	Uniaxial		Uniaxial		Uniaxial	
Gage Factor	Approx. 2.0		Approx. 2.0		Approx. 1.9	
Base	3.3 × 2.7 mm		2.5 × 2.2 mm		1.6 × 1.2 mm	
Gage (Grid)	0.5 × 1.4 mm		0.2 × 1 mm		0.2 × 0.9 mm	
Resistance	120 Ω		120 Ω		120 Ω	
Pieces per Pack	10		10		10	

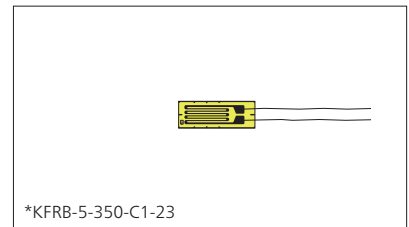
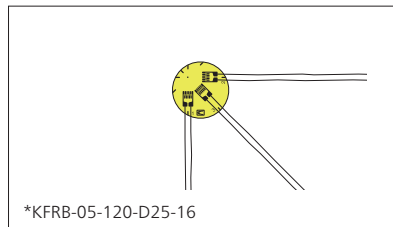
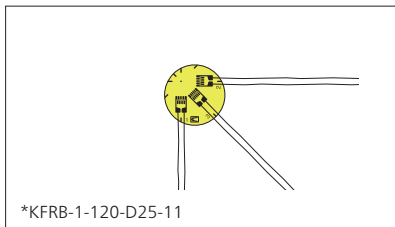

Models	KFRB-1-120-D25-	11 16 23	KFRB-05-120-D25-	11 16 23	KFRB-5-350-C1-	11 16 23
Pattern	Triaxial, 0°/90°/45°		Triaxial, 0°/90°/45°		Uniaxial	
Gage Factor	Approx. 2.0		Approx. 2.0		Approx. 2.0	
Base	φ8		φ7.5		10 × 3.7 mm	
Gage (Grid)	1 × 1.5 mm		0.5 × 1.4 mm		5 × 2.4 mm	
Resistance	120 Ω		120 Ω		350 Ω	
Pieces per Pack	5		5		10	

KFRB ● Uniaxial, Triaxial

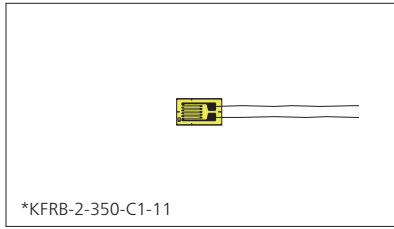

*KFRB-2-350-C1-11

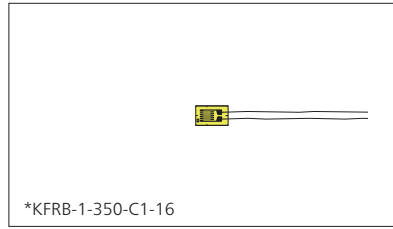

*KFRB-1-350-C1-16

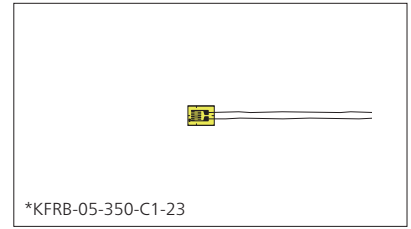

*KFRB-05-350-C1-23

Models	KFRB-2-350-C1-	11 16 23	KFRB-1-350-C1-	11 16 23	KFRB-05-350-C1-	11 16 23
Pattern	Uniaxial		Uniaxial		Uniaxial	
Gage Factor	Approx. 2.0		Approx. 2.0		Approx. 2.0	
Base	6 × 3.7 mm		4 × 2.7 mm		3.5 × 2.7 mm	
Gage (Grid)	2 × 2.4 mm		1 × 1.5 mm		0.5 × 1.5 mm	
Resistance	350 Ω		350 Ω		350 Ω	
Pieces per Pack	10		10		10	

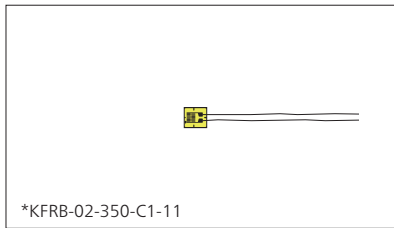

*KFRB-02-350-C1-11

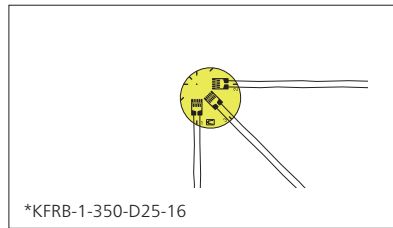

*KFRB-1-350-D25-16

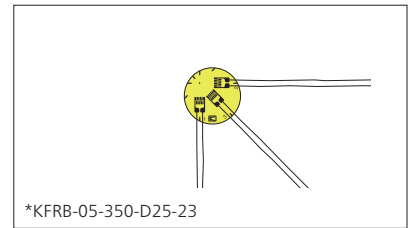

*KFRB-05-350-D25-23

Models	KFRB-02-350-C1-	11 16 23	KFRB-1-350-D25-	11 16 23	KFRB-05-350-D25-	11 16 23
Pattern	Uniaxial		Triaxial, 0°/90°/45°		Triaxial, 0°/90°/45°	
Gage Factor	Approx. 2.0		Approx. 2.0		Approx. 2.0	
Base	3 × 2.7 mm		φ8		φ7.5	
Gage (Grid)	0.2 × 1.5 mm		1 × 1.5 mm		0.5 × 1.5 mm	
Resistance	350 Ω		350 Ω		350 Ω	
Pieces per Pack	10		5		5	

When ordering, specify the model number as follows.

KFRB-□-□-□-□ Lead-wire Cable Code

e.g.

KFRB-5-120-C1-11 L1M3R

*Values in □ and lead-wire cable code cannot be arbitrarily combined.

Lead-wire Cable Type and Shape	Oprg. Temp.	Length	Code
Vinyl-coated flat 3-wire cable L-7 (L-10 for 6 m or longer)	-10 to 80°C	1 m	L1M3R:L1M3S
		3 m	L3M3R:L3M3S
		5 m	L5M3R:L5M3S
Vinyl-coated flat 2-wire cable L-6 (L-9 for 6 m or longer)	-10 to 80°C	1 m	L1M2R:L1M2S
		3 m	L3M2R:L3M2S
		5 m	L5M2R:L5M2S
Mid-temperature 3-wire cable L-12	-100 to 150°C	1 m	R1M3
		3 m	R3M3
		5 m	R5M3
Mid-temperature 2-wire cable L-11	-100 to 150°C	1 m	R1M2
		3 m	R3M2
		5 m	R5M2
3 polyester-coated copper wires	-196 to 150°C	30 cm	N30C3
		50 cm, 1 m	N50C3
		1 m	N1M3
2 polyester-coated copper wires	-196 to 150°C	10 cm	N10C2
		30 cm	N30C2
		50 cm, 1 m	N50C2
Silver-covered copper wires	-196 to 150°C	25 mm	N1M2

*Gage (Grid): Length × Width

KFRB ● Uniaxial, Triaxial

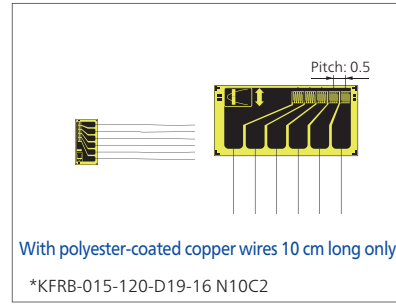
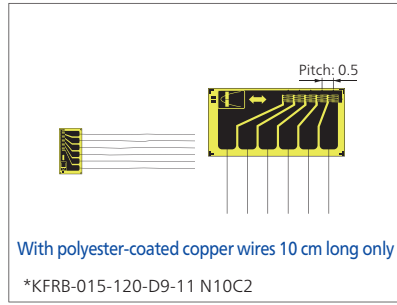

Models	KFRB-015-120-D9- 11 N10C2 16 23
Pattern	Uniaxial 5-element, for concentrated stress measurement
Gage Factor	Approx. 2.0
Base	6 × 3 mm
Gage (Grid)	0.15 × 0.34 mm
Resistance	120 Ω
Pieces per Pack	5

Models	KFRB-015-120-D19- 11 N10C2 16 23
Pattern	Uniaxial 5-element, for concentrated stress measurement
Gage Factor	Approx. 2.0
Base	6 × 3 mm
Gage (Grid)	0.15 × 0.45 mm
Resistance	120 Ω
Pieces per Pack	5

Lead-wire Cable Type and Shape	Oprg. Temp.	Length
2 polyester-coated copper wires  10 cm	-196 to 150°C	10 cm

*Gage (Grid): Length × Width

Waterproof Strain Gages

KFWB

- Gage Factor Approx. 2.1
- Applicable Linear Expansion Coefficients ($\times 10^{-6}/^{\circ}\text{C}$) 11, 16, 23
- Self-temperature-compensation Range 10 to 80°C

Applicable Adhesives and Operating Temperature Ranges

- CC-33A: -10 to 80°C
- CC-36: -10 to 80°C
- EP-340: -10 to 80°C

Waterproof Foil Strain Gages

RoHS

The surface of the KFWB series foil strain gage is covered with a special waterproof resin. The waterproof structure enables these gages to serve for outdoor or underwater measurement merely by being bonded to measuring objects. (The insulation resistance shows virtually no deterioration even after 100 hours of use under an underwater pressure of approximately 10 MPa.) In addition, the covering resin is flexible enough to enable easy bonding to curved surfaces.

Types, lengths and codes of lead-wire cables pre-attached to KFWB series gages

Type	Vinyl-coated flat 2-wire cable		Vinyl-coated flat 3-wire cable	
	C1	D16, D17	C1	D16, D17
Length				
15 cm	L15C2R	L15C2S	L15C3R	L15C3S
30 cm	L30C2R	L30C2S	L30C3R	L30C3S
1 m	L1M2R	L1M2S	L1M3R	L1M3S
3 m	L3M2R	L3M2S	L3M3R	L3M3S
5 m	L5M2R	L5M2S	L5M3R	L5M3S
Operating temp.	-10 to 80°C			
Remarks	L-6 L-9 for ≥ 6 m		L-7 L-10 for ≥ 6 m	

*For other lead-wire cable lengths, contact us.

KFWB ● Uniaxial, Biaxial

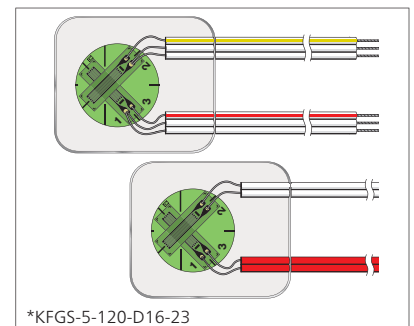
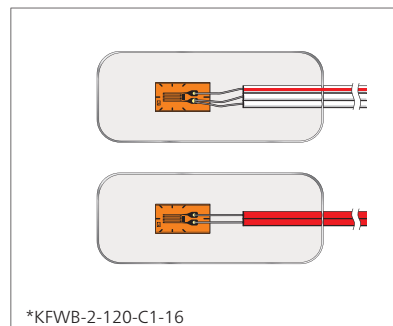
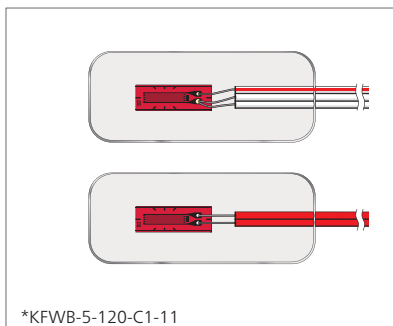

Models	KFWB-5-120-C1-	11 16 23	KFWB-2-120-C1-	11 16 23	KFWB-5-120-D16-	11 16 23
Pattern	Uniaxial		Uniaxial		Biaxial, 0°/90° stacked rosette	
Base	30 × 12 mm		30 × 12 mm		21 × 18 mm	
Gage (Grid)	5 × 1.4 mm		2 × 1.2 mm		5 × 1.4 mm	
Resistance	120 Ω		120 Ω		120 Ω	
Pieces per Pack	10		10		5	

When ordering, specify the model number as follows.

KFWB-□-120-□-□ Lead-wire Cable Code

e.g. KFWB-5-120-C1-11 L1M3R

*Values in □ and lead-wire cable code cannot be arbitrarily combined.

Lead-wire Cable Type and Shape	Oprg. Temp.	Length	Code
Vinyl-coated flat 3-wire cable L-7 (L-10 for 6 m or longer)	-10 to 80°C	1 m	L1M3R;L1M3S
		3 m	L3M3R;L3M3S
		5 m	L5M3R;L5M3S
Vinyl-coated flat 2-wire cable L-6 (L-9 for 6 m or longer)	-10 to 80°C	1 m	L1M2R;L1M2S
		3 m	L3M2R;L3M2S
		5 m	L5M2R;L5M2S

*Gage (Grid): Length × Width

KFWB ● Uniaxial, Biaxial, Triaxial

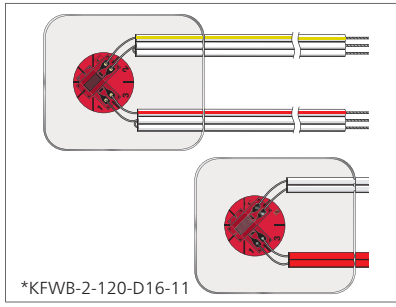

*KFWB-2-120-D16-11

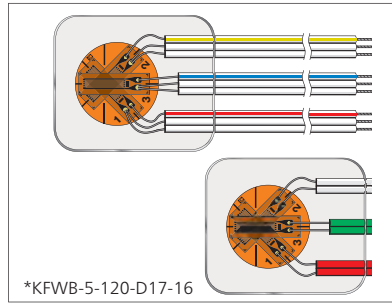

*KFWB-5-120-D17-16

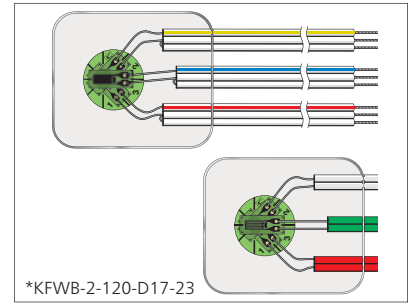

*KFWB-2-120-D17-23

Models	KFWB-2-120-D16-	11 16 23	KFWB-5-120-D17-	11 16 23	KFWB-2-120-D17-	11 16 23
Pattern	Biaxial, 0°/90° stacked rosette		Triaxial, 0°/45°/90° stacked rosette		Triaxial, 0°/45°/90° stacked rosette	
Base	21 × 18 mm		21 × 18 mm		21 × 18 mm	
Gage (Grid)	2 × 1.2 mm		5 × 1.4 mm		2 × 1.2 mm	
Resistance	120 Ω		120 Ω		120 Ω	
Pieces per Pack	5		5		5	

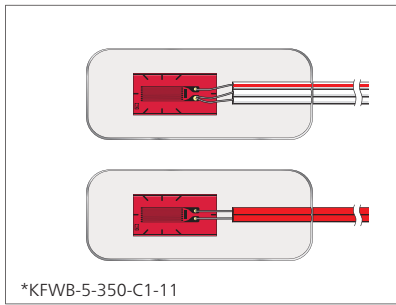

*KFWB-5-350-C1-11

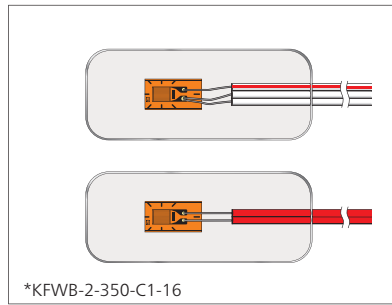

*KFWB-2-350-C1-16

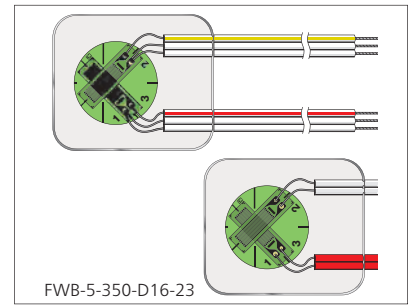

FWB-5-350-D16-23

Models	KFWB-5-350-C1-	11 16 23	KFWB-2-350-C1-	11 16 23	KFWB-5-350-D16-	11 16 23
Pattern	Uniaxial		Uniaxial		Biaxial, 0°/90° stacked rosette	
Base	30 × 12 mm		30 × 12 mm		21 × 18 mm	
Gage (Grid)	5 × 2 mm		2 × 2 mm		5 × 2 mm	
Resistance	350 Ω		350 Ω		350 Ω	
Pieces per Pack	10		10		5	

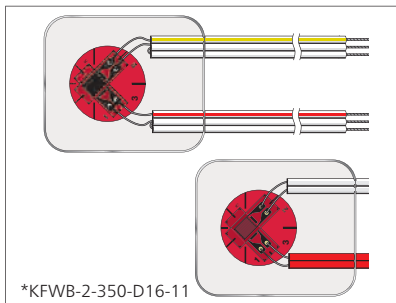

*KFWB-2-350-D16-11

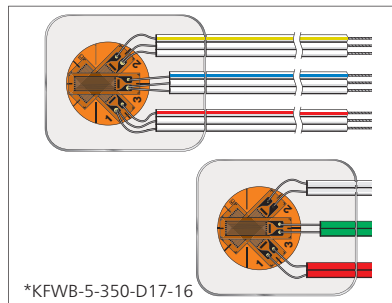

*KFWB-5-350-D17-16

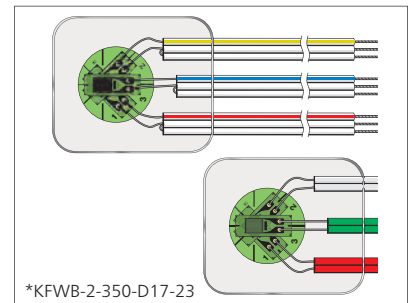

*KFWB-2-350-D17-23

Models	KFWB-2-350-D16-	11 16 23	KFWB-5-350-D17-	11 16 23	KFWB-2-350-D17-	11 16 23
Pattern	Biaxial, 0°/90° stacked rosette		Triaxial, 0°/45°/90° stacked rosette		Triaxial, 0°/45°/90° stacked rosette	
Base	21 × 18 mm		21 × 18 mm		21 × 18 mm	
Gage (Grid)	2 × 2 mm		5 × 2 mm		2 × 2 mm	
Resistance	350 Ω		350 Ω		350 Ω	
Pieces per Pack	5		5		5	

Waterproof Strain Gages

KFWS

RoHS

● Gage Factor	Approx. 2.1
● Applicable Linear Expansion Coefficients ($\times 10^{-6}/^{\circ}\text{C}$)	11, 16, 23
● Self-temperature-compensation Range	10 to 80°C

Applicable Adhesives and Operating Temperature Ranges

CC-33A:	-10 to 80°C
CC-36:	-10 to 80°C
EP-340:	-10 to 80°C

Small-sized Waterproof Foil Strain Gages

The KFWS series foil strain gages are small-sized waterproof gages suitable for outdoor or underwater strain measurement where gage bonding space is limited. The waterproof resin is as thin as 1.3 mm, making them flexible enough to be bonded to a curved surface of 10 mm diameter.

Types, lengths and codes of lead-wire cables pre-attached to KFWS series gages

Type Length	Vinyl-coated flat 2-wire cable		Vinyl-coated flat 3-wire cable	
	C1	D16	C1	D16
15 cm	L15C2R	L15C2S	L15C3R	L15C3S
30 cm	L30C2R	L30C2S	L30C3R	L30C3S
1 m	L1M2R	L1M2S	L1M3R	L1M3S
3 m	L3M2R	L3M2S	L3M3R	L3M3S
5 m	L5M2R	L5M2S	L5M3R	L5M3S
Operating temp.	-10 to 80°C			
Remarks	L-6 L-9 for ≥ 6 m		L-7 L-10 for ≥ 6 m	

* For other lead-wire cable lengths, contact us.

KFWS ● Uniaxial, Biaxial

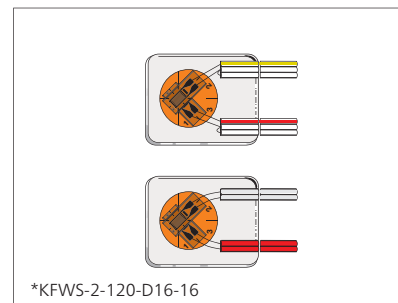
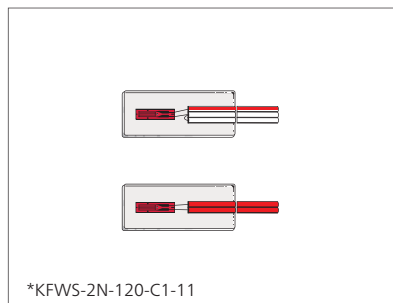

Models	KFWS-2N-120-C1-	11 16 23
Pattern	Uniaxial	
Base	15 × 6 mm	
Gage (Grid)	2 × 0.84 mm	
Resistance	120 Ω	
Pieces per Pack	10	

Models	KFWS-2-120-D16-	11 16 23
Pattern	Biaxial, 0°/90° stacked rosette	
Base	15 × 12 mm	
Gage (Grid)	2 × 1.2 mm	
Resistance	120 Ω	
Pieces per Pack	10	

When ordering, specify the model number as follows.

KFWS-□-120-□-□ Lead-wire Cable Code

(e.g.)

KFWS-2N-120-C1-11 L1M3R

*Values in □ and lead-wire cable code cannot be arbitrarily combined.

Lead-wire Cable Type and Shape	Oprg. Temp.	Length	Code
Vinyl-coated flat 3-wire cable L-7 (L-10 for 6 m or longer)	-10 to 80°C	1 m	L1M3R;L1M3S
		3 m	L3M3R;L3M3S
		5 m	L5M3R;L5M3S
Vinyl-coated flat 2-wire cable L-6 (L-9 for 6 m or longer)	-10 to 80°C	1 m	L1M2R;L1M2S
		3 m	L3M2R;L3M2S
		5 m	L5M2R;L5M2S

*Gage (Grid): Length × Width

Waterproof Strain Gages

KCW

● Gage Factor	Approx. 2.2
● Applicable Linear Expansion Coefficients ($\times 10^{-6}/^{\circ}\text{C}$)	11
● Self-temperature-compensation Range	10 to 90°C
● Flange Size	21×5×0.1 mm

Bonding Methods and Operating Temperature Ranges
Spot welding: -20 to 100°C

■ Weldable Waterproof Foil **RoHS** Strain Gages

The KCW series foil strain gages are weldable gages, which do not require any coating treatment for use under high pressure or under water. The G10 type endures a water pressure of approximately 10 MPa.

■ Types, lengths and codes of lead-wire cables pre-attached to KCW gages

Type	Chloroprene 3-wire cable
Length	G10
15 cm	G15C3S
30 cm	G30C3S
1 m	G1M3S
3 m	G3M3S
5 m	G5M3S
Operating temp.	-20 to 100°C

* For other lead-wire cable lengths, contact us.

KCW ● Uniaxial

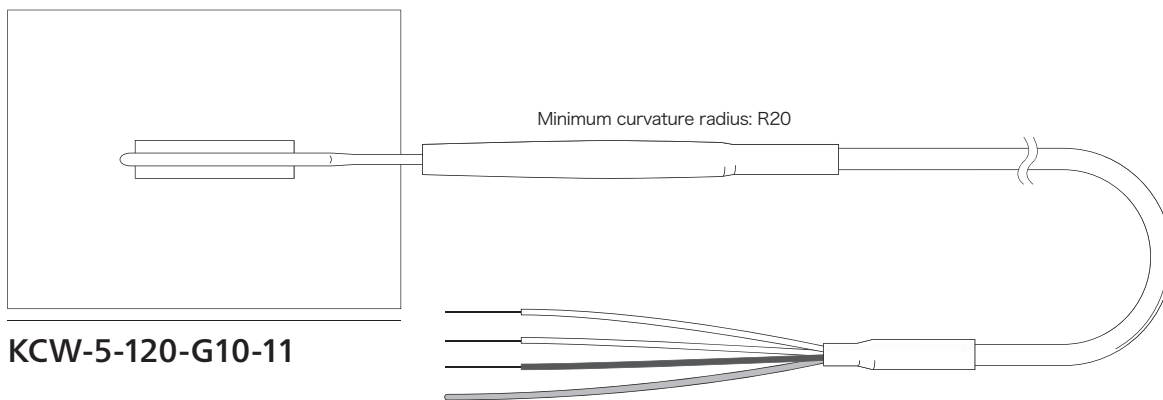

Models	KCW-5-120-G10-11
Pattern	Uniaxial
Base	21 × 5 mm
Gage (Grid)	5 mm
Resistance	120 Ω
Pieces per Pack	2

When ordering, specify the model number as follows.

KCW-5-120-G10-11 Lead-wire Cable Code

(e.g.) KCW-5-120-G10-11 G1M3S

Lead-wire Cable Type and Shape	Oprg. Temp.	Length	Code
Chloroprene 3-wire cable Minimum curvature radius: R20	-20 to 100°C	1 m	G1M3S
		3 m	G3M3S
		5 m	G5M3S

*Gage (Grid): Length

Strain Gages for Concrete

KFGS

● Gage Factor	Approx. 2.1
● Applicable Linear Expansion Coefficients ($\times 10^{-6}/^{\circ}\text{C}$)	11
● Self-temperature-compensation Range	10 to 100°C

Applicable Adhesives and Operating Temperature Ranges
CC-35: -10 to 80°C

General-purpose Foil Strain Gages

RoHS

Listed here are the KFGS series gages with a suitable lead-wire cable for strain measurement of concrete.

KFGS ● Uniaxial, Biaxial, Triaxial

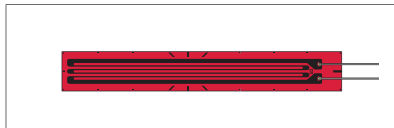

Models	KFGS-30-120-C1-11
Pattern	Uniaxial
Base	37 × 5.2 mm
Gage (Grid)	30 × 3.3 mm
Resistance	120 Ω
Pieces per Pack	10

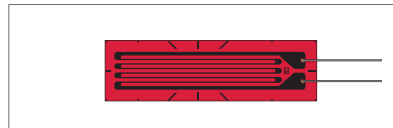

Models	KFGS-20-120-C1-11
Pattern	Uniaxial
Base	28 × 8 mm
Gage (Grid)	20 × 5 mm
Resistance	120 Ω
Pieces per Pack	10

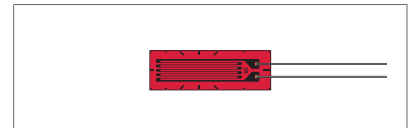

Models	KFGS-10-120-C1-11
Pattern	Uniaxial
Base	16 × 5.2 mm
Gage (Grid)	10 × 3 mm
Resistance	120 Ω
Pieces per Pack	10

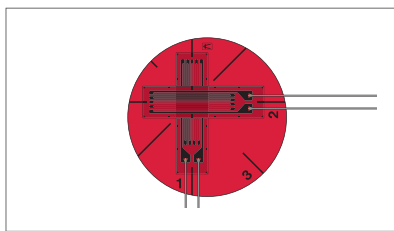

Models	KFGS-10-120-D16-11
Pattern	Biaxial, 0°/90° stacked rosette
Base	φ21
Gage (Grid)	10 × 3 mm
Resistance	120 Ω
Pieces per Pack	10

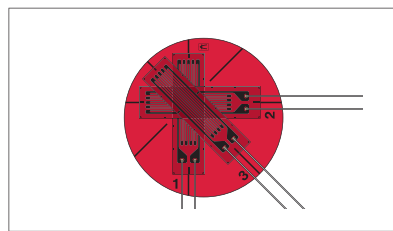

Models	KFGS-10-120-D17-11
Pattern	Triaxial, 0°/90°/45° stacked rosette for stress analysis
Base	φ21
Gage (Grid)	10 × 3 mm
Resistance	120 Ω
Pieces per Pack	10

When ordering, specify the model number as follows.

KFGS-□-120-□-11 Lead-wire Cable Code

(e.g.)

KFGS-30-120-C1-11 L1M3R

*Values in □ and lead-wire cable code cannot be arbitrarily combined.

Lead-wire Cable Type and Shape	Oprg. Temp.	Length	Code
Vinyl-coated flat 3-wire cable L-7 (L-10 for 6 m or longer)	-10 to 80°C	1 m	L1M3R:L1M3S
		3 m	L3M3R:L3M3S
		5 m	L5M3R:L5M3S
Vinyl-coated flat 2-wire cable L-6 (L-9 for 6 m or longer)	-10 to 80°C	1 m	L1M2R:L1M2S
		3 m	L3M2R:L3M2S
		5 m	L5M2R:L5M2S
Mid-temperature 3-wire cable L-12	-100 to 150°C	1 m	R1M3
		3 m	R3M3
		5 m	R5M3
Mid-temperature 2-wire cable L-11	-100 to 150°C	1 m	R1M2
		3 m	R3M2
		5 m	R5M2
3 polyester-coated copper wires	-196 to 150°C	30 cm	N30C3
		50 cm, 1 m	N50C3
		1 m	N1M3
2 polyester-coated copper wires	-196 to 150°C	30 cm	N30C2
		50 cm, 1 m	N50C2
		1 m	N1M2
Silver-covered copper wires	-196 to 150°C	25 mm	

*Gage (Grid): Length × Width

Strain Gages for Concrete

KC

RoHS

● Gage Factor	Approx. 2.1
● Applicable Linear Expansion Coefficients ($\times 10^{-6}/^{\circ}\text{C}$)	11
● Self-temperature-compensation Range	10 to 60°C

Applicable Adhesives and Operating Temperature Ranges
CC-35: -30 to 120°C

Wire Strain Gages
Featuring a longer gage length, the KC series gages are wire strain gages suitable for mean strain measurement of concrete under test. Usually, a model with the gage length over 3 times longer than the maximum diameter of the aggregate is selected for the purpose.

■ Types, lengths and codes of lead-wire cables pre-attached to KC series gages

Type	Vinyl-coated flat 2-wire cable	Vinyl-coated flat 3-wire cable
Length	A1	
15 cm	L15C2R	L15C3R
30 cm	L30C2R	L30C3R
1 m	L1M2R	L1M3R
3 m	L3M2R	L3M3R
5 m	L5M2R	L5M3R
Operating temp.	-10 to 80°C	
Remarks	L-6 L-9 for ≥ 6 m	L-7 L-10 for ≥ 6 m

KC with a vinyl-coated 3-wire or 2-wire cable

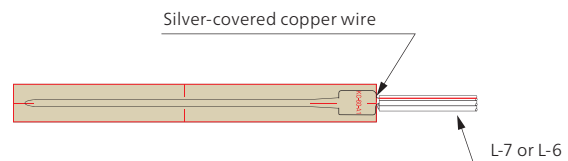

* For other lead-wire cable lengths, contact us.

KC ● Uniaxial

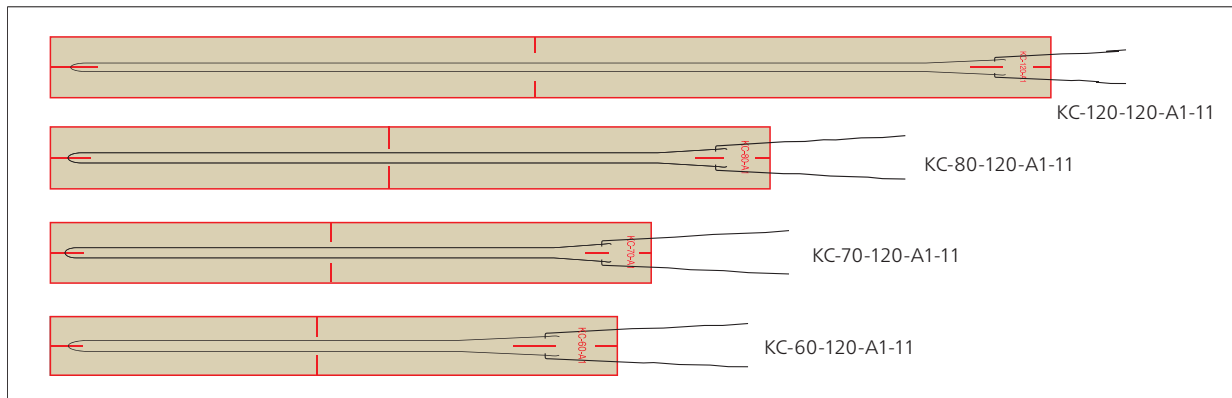

Models	KC-120-120-A1-11	KC-80-120-A1-11	KC-70-120-A1-11	KC-60-120-A1-11
Pattern	Uniaxial	Uniaxial	Uniaxial	Uniaxial
Base	132 × 8 mm	95 × 8 mm	80 × 8 mm	74 × 8 mm
Gage (Grid)	120 × 0.6 mm	84 × 0.6 mm	67 × 0.6 mm	60 × 0.6 mm
Resistance	120 Ω	120 Ω	120 Ω	120 Ω
Pieces per Pack	10	10	10	10

When ordering, specify the model number as follows.

KC-□-120-A1-11 Lead-wire Cable Code

(e.g.)

KC-120-120-A1-11 L1M3R

*Values in □ and lead-wire cable code cannot be arbitrarily combined.

Lead-wire Cable Type and Shape	Oprg. Temp.	Length	Code
Vinyl-coated flat 3-wire cable L-7 (L-10 for 6 m or longer)	-10 to 80°C	1 m	L1M3R
		3 m	L3M3R
		5 m	L5M3R
Vinyl-coated flat 2-wire cable L-6 (L-9 for 6 m or longer)	-10 to 80°C	1 m	L1M2R
		3 m	L3M2R
		5 m	L5M2R
Silver-covered copper wires	-196 to 150°C	25 mm	

*Gage (Grid): Length × Width

Strain Gages for Concrete

KM

● Gage Factor	Approx. 1.8, 2.0 (Reference value)
● Applicable Linear Expansion Coefficients ($\times 10^{-6}/^{\circ}\text{C}$)	11
● Self-temperature-compensation Range	0 to 50°C

Operating Temperature Ranges
-10 to 70°C

■ Embedded Strain Gages RoHS

The KM series gages are designed to be embedded in mortar or concrete for the purpose of measuring internal stress. To ensure better adhesion to mortar or the like, the KM series gages feature a specially treated surface. They also provide suitable waterproofness and elastic modulus for the intended purpose.

■ Types, lengths and codes of lead-wire cables pre-attached to KM gages

Type	KM-30 Vinyl-coated flat 2-wire cable	KM-120 Vinyl-coated flat 3-wire cable
Length	H1	H2
1 m	Y1M2	W1M3
3 m	Y3M2	W3M3
5 m	Y5M2	W5M3
Operating temp.	-10 to 70°C	

* For other lead-wire cable lengths, contact us.

KM ● Uniaxial

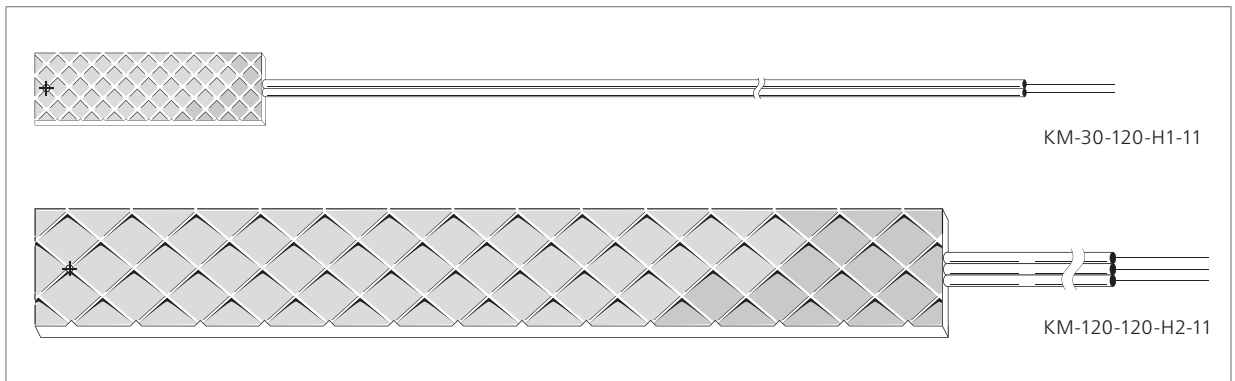

KM-30-120-H1-11

KM-120-120-H2-11

Models	KM-30-120-H1-11	KM-120-120-H2-11
Pattern	Uniaxial, foil strain gage with vinyl-coated flat 2-wire cable	Uniaxial, wire strain gage with vinyl-coated flat 3-wire cable
Gage Factor	Approx. 1.8	Approx. 2.0
Base	30 × 9 × 3 mm	120 × 15 × 5 mm
Gage (Grid)	10 mm	70 mm
Resistance	120 Ω	120 Ω
Pieces per Pack	1	1

When ordering, specify the model number as follows

KM-□-120-□-11 Lead-wire Cable Code

(e.g.)

KM-30-120-H1-11 Y1M2

*Values in □ and lead-wire cable code cannot be arbitrarily combined.

*Gage (Grid): Length

Operating Temperature Ranges
Normal temperature to 70°C

Concrete-embedded Strain Gages

RoHS

The KMC series gages are designed to measure self-shrinkage and self-stress of cemented materials. They enable measurement of the self-shrinkage and high-fluidity concrete immediately after placing. They are also used effectively to check for cracks of cemented materials.

Usually, a T-type thermocouple is installed near the gage, while the KMC series gages of H4 type do not require such the installation since they are equipped with a built-in thermocouple.

KMC ● Uniaxial

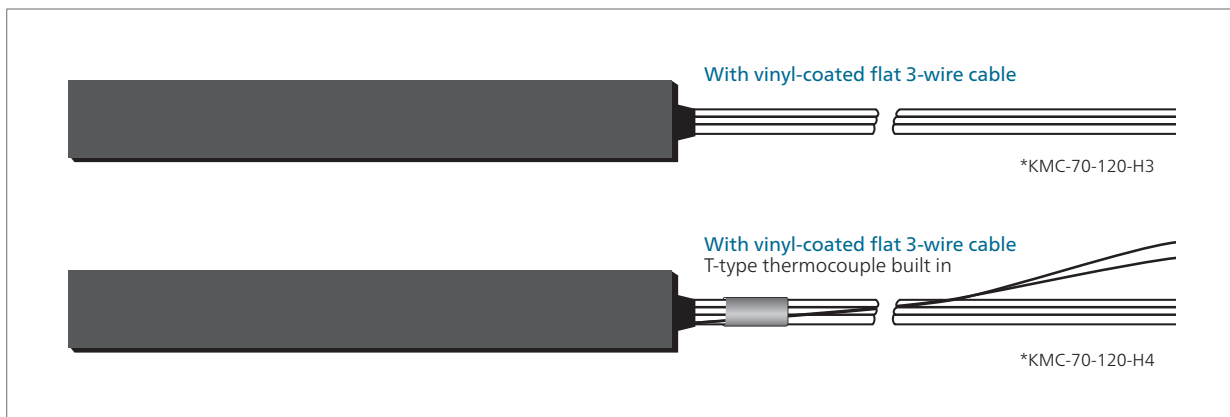

Models	KMC-70-120-H3	KMC-70-120-H4
Pattern	Uniaxial, wire strain gage with vinyl-coated flat 3-wire cable 3 m long	Uniaxial, wire strain gage with vinyl-coated flat 3-wire cable 3 m long
Base	80 × 10 × 2 mm	80 × 10 × 2 mm
Gage (Grid)	67 mm	67 mm
Resistance	120 Ω	120 Ω
Built-in Thermocouple	—	T
Pieces per Pack	1	1

*Gage (Grid): Length

Strain Gages for Composite Materials and Plastics

KFRPB

● Gage Factor	Approx. 2.0
● Applicable Linear Expansion Coefficients ($\times 10^{-6}/^{\circ}\text{C}$)	1, 3, 6, 9
● Self-temperature-compensation Range	0 to 150°C

Applicable Adhesives and Operating Temperature Ranges

CC-33A:	-196 to 120°C
CC-35:	-30 to 120°C
CC-36:	-30 to 100°C
EP-34B:	-55 to 200°C

■ Foil Strain Gages for Composite Materials RoHS

The KFRPB series foil strain gages are self-temperature-compensation gages (SELCOM gages) suitable for strain measurement of composite materials such as CFRP and GFRP. The special gage pattern minimizes the effect of self-heating due to gage current and the effect of reinforcement of low-elasticity materials.

■ Types, lengths and codes of lead-wire cables pre-attached to KFRPB gages

Type	2 polyester-coated copper wires		3 polyester-coated copper wires		Vinyl-coated flat 2-wire cable		Vinyl-coated flat 3-wire cable		Mid-temperature 2-wire cable	Mid-temperature 3-wire cable	Fluoroplastic coated high/low-temp. 3-wire cable
	C1, D22	C1, D22	C1, D22	C1, D22	C1	D22	C1	D22	C1, D22	C1, D22	C1, D22
Length											
15 cm	N15C2	N15C3	L15C2R	L15C2S	L15C3R	L15C3S	R15C2	R15C3	F15C3		
30 cm	N30C2	N30C3	L30C2R	L30C2S	L30C3R	L30C3S	R30C2	R30C3	F30C3		
1 m	N1M2	N1M3	L1M2R	L1M2S	L1M3R	L1M3S	R1M2	R1M3	F1M3		
3 m	—	—	L3M2R	L3M2S	L3M3R	L3M3S	R3M2	R3M3	F3M3		
5 m	—	—	L5M2R	L5M2S	L5M3R	L5M3S	R5M2	R5M3	F5M3		
Operating temp.	-196 to 150°C		-10 to 80°C				-100 to 150°C		-196 to 200°C		
Remarks	Twisted for ≥ 50 cm		L-6 L-9 for ≥ 6 m		L-7 L-10 for ≥ 6 m		L-11*	L-12*	L-3*		

* For type R and type F of lead-wire cable with glass-cloth tape, see page 23.

** For other lead-wire cable lengths, contact us.

KFRPB ● Uniaxial, Triaxial

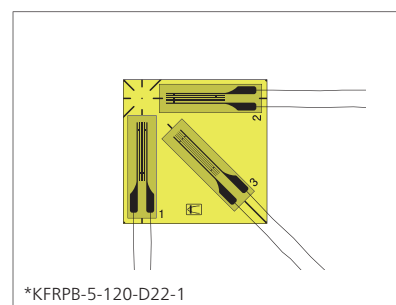
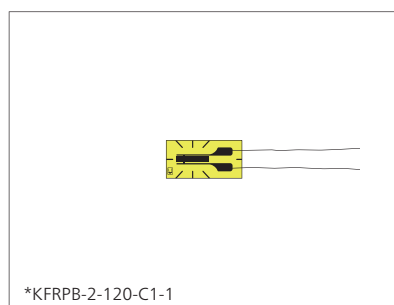
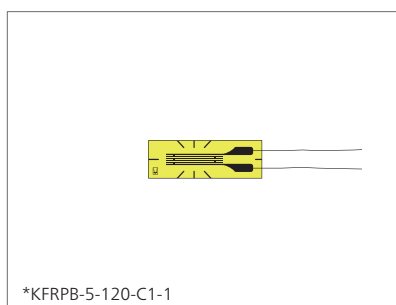

Models	KFRPB-5-120-C1-	1 3 6 9	KFRPB-2-120-C1-	1 3 6 9	KFRPB-5-120-D22-	1 3 6 9
Pattern	Uniaxial		Uniaxial		Triaxial, 0°/90°/45°	
Base	15 × 5 mm		10 × 5 mm		19 × 19 mm	
Gage (Grid)	5 × 1.4 mm		2 × 1.2 mm		5 × 1.4 mm	
Resistance	120 Ω		120 Ω		120 Ω	
Pieces per Pack	10		10		10	

KFRPB ● Uniaxial, Triaxial

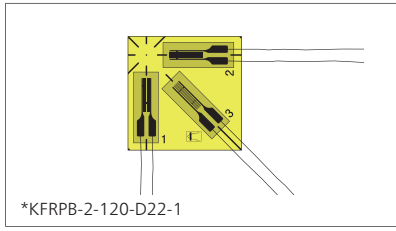

*KFRPB-2-120-D22-1

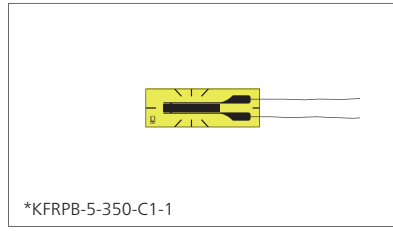

*KFRPB-5-350-C1-1

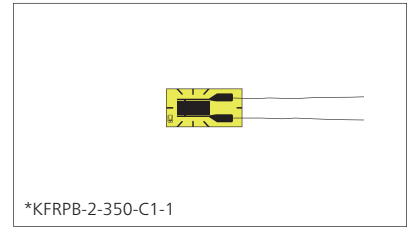

*KFRPB-2-350-C1-1

Models	KFRPB-2-120-D22-	1 3 6 9	KFRPB-5-350-C1-	1 3 6 9	KFRPB-2-350-C1-	1 3 6 9
Pattern	Triaxial, 0°/90°/45° plane arrangement		Uniaxial		Uniaxial	
Base	15 × 15 mm		15 × 5 mm		10 × 5 mm	
Gage (Grid)	2 × 1.2 mm		5 × 1.5 mm		2 × 2.2 mm	
Resistance	120 Ω		350 Ω		350 Ω	
Pieces per Pack	10		10		10	

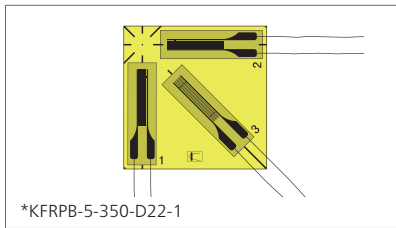

*KFRPB-5-350-D22-1

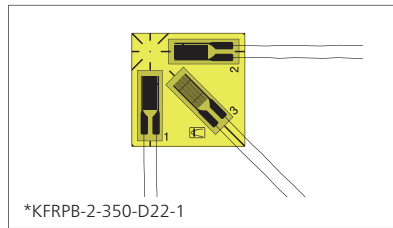

*KFRPB-2-350-D22-1

Models	KFRPB-5-350-D22-	1 3 6 9	KFRPB-2-350-D22-	1 3 6 9
Pattern	Triaxial, 0°/90°/45° plane arrangement		Triaxial, 0°/90°/45° plane arrangement	
Base	19 × 19 mm		15 × 15 mm	
Gage (Grid)	5 × 1.5 mm		2 × 2.2 mm	
Resistance	350 Ω		350 Ω	
Pieces per Pack	10		10	

When ordering, specify the model number as follows.

KFRPB-□-□-□-□ **Lead-wire Cable Code**

(e.g.)

KFRPB-5-120-C1-1 L1M3R

*Values in □ and lead-wire cable code cannot be arbitrarily combined.

Lead-wire Cable Type and Shape	Oprg. Temp.	Length	Code
Vinyl-coated flat 3-wire cable L-7 (L-10 for 6 m or longer)	-10 to 80°C	1 m	L1M3R:L1M3S
		3 m	L3M3R:L3M3S
		5 m	L5M3R:L5M3S
Vinyl-coated flat 2-wire cable L-6 (L-9 for 6 m or longer)	-10 to 80°C	1 m	L1M2R:L1M2S
		3 m	L3M2R:L3M2S
		5 m	L5M2R:L5M2S
Mid-temperature 3-wire cable L-12	-100 to 150°C	1 m	R1M3
		3 m	R3M3
		5 m	R5M3
Mid-temperature 2-wire cable L-11	-100 to 150°C	1 m	R1M2
		3 m	R3M2
		5 m	R5M2
Fluoroplastic-coated high/low-temp. 3-wire cable L-3	-196 to 200°C	1 m	F1M3
		3 m	F3M3
		5 m	F5M3
3 polyester-coated copper wires	-196 to 150°C	30 cm	N30C3
		50 cm	N50C3
		1 m	N1M3
2 polyester-coated copper wires	-196 to 150°C	30 cm	N30C2
		50 cm	N50C2
		1 m	N1M2
Silver-covered copper wires	-196 to 200°C	25 mm	

*Gage (Grid): Length × Width

● Gage Factor	Approx. 2.0
● Applicable Linear Expansion Coefficients ($\times 10^{-6}/^{\circ}\text{C}$)	13
● Self-temperature-compensation Range	-30 to 120°C

Applicable Adhesives and Operating Temperature Ranges

- CC-33A: -196 to 120°C
- CC-36: -30 to 100°C
- PC-600: -196 to 150°C

Foil Strain Gages for Printed Boards

PCB are used for varieties of products including cellular phones, car navigation systems and digital cameras. The gages are the self-temperature-compensation gages (SELCOM gages) for evaluating them.

- Dimensions of gage base (bondable space to mounted components and narrow parts) 1.2 mm long by 1.1 mm wide (uniaxial), 2.5 mm long by 2.5 mm wide (Biaxial or triaxial)
- Linear expansion coefficient of $13 \times 10^{-6}/^{\circ}\text{C}$, suitable for component-mounted board
- Self-temperature-compensation range is made as wide as -30 to 120°C to satisfy thermal cyclic tests of PCB.

Types, lengths and codes of lead-wire cables pre-attached to KFRS gages

Type	2 polyester-coated copper wires		3 polyester-coated copper wires		Vinyl-coated flat 2-wire cable		Vinyl-coated flat 3-wire cable		Mid-temperature 2-wire cable	Mid-temperature 3-wire cable
	C1, D34, D35	C1, D34, D35	C1, D34, D35	C1, D34, D35	C1	D34, D35	C1	D34, D35	C1, D34, D35	C1, D34, D35
Length	C1, D34, D35	C1, D34, D35	C1, D34, D35	C1, D34, D35	C1	D34, D35	C1	D34, D35	C1, D34, D35	C1, D34, D35
10 cm	N10C2	N10C3	---	---	---	---	---	---	---	---
30 cm	N30C2	N30C3	L30C2R	L30C2S	L30C3R	L30C3S	L30C2	L30C3	L30C2	R30C3
1 m	N1M2	N1M3	L1M2R	L1M2S	L1M3R	L1M3S	R1M2	R1M3	R1M2	R1M3
3 m	---	---	L3M2R	L3M2S	L3M3R	L3M3S	R3M2	R3M3	R3M2	R3M3
5 m	---	---	L5M2R	L5M2S	L5M3R	L5M3S	R5M2	R5M3	R5M2	R5M3
Operating temp.	-196 to 150°C				-10 to 80°C				-100 to 150°C	
Remarks	Twisted for ≥ 50 cm		---		L-6		L-7		L-11*	L-12*

* For type R of lead-wire cable with glass-cloth tape, see page 23.

** For other lead-wire cable lengths, contact us.

KFRS ● Uniaxial

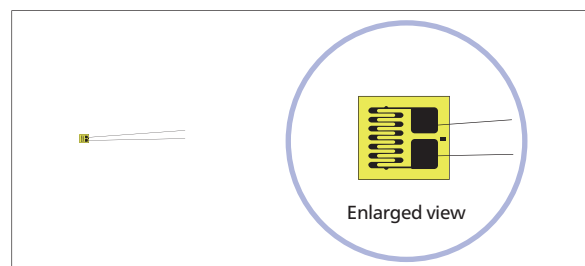
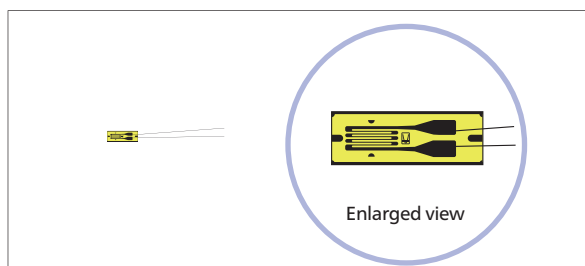

Models	KFRS-1-120-C1-13
Pattern	Uniaxial
Base	4 × 1.4 mm
Gage (Grid)	1 × 0.65 mm
Resistance	120 Ω
Pieces per Pack	10

Models	KFRS-02-120-C1-13
Pattern	Uniaxial
Base	1.2 × 1.1 mm
Gage (Grid)	0.2 × 0.8 mm
Resistance	120 Ω
Pieces per Pack	10

When ordering, specify the model number as follows.

KFRS-□-120-C1-13 □ Lead-wire Cable Code

(e.g.)

KFRS-1-120-C1-13 L1M3R

*Values in □ and lead-wire cable code cannot be arbitrarily combined.

Lead-wire Cable Type and Shape	Oprg. Temp.	Length	Code
Vinyl-coated flat 3-wire cable L-7 (L-10 for 6 m or longer)	-10 to 80°C	1 m	L1M3R:L1M3S
		3 m	L3M3R:L3M3S
		5 m	L5M3R:L5M3S
Vinyl-coated flat 2-wire cable L-6 (L-9 for 6 m or longer)	-10 to 80°C	1 m	L1M2R:L1M2S
		3 m	L3M2R:L3M2S
		5 m	L5M2R:L5M2S
Mid-temperature 3-wire cable L-12	-100 to 150°C	1 m	R1M3
		3 m	R3M3
		5 m	R5M3
Mid-temperature 2-wire cable L-11	-100 to 150°C	1 m	R1M2
		3 m	R3M2
		5 m	R5M2
3 polyester-coated copper wires	-196 to 150°C	10 cm	N10C3
2 polyester-coated copper wires	-196 to 150°C	30 cm	N30C3
		10 cm	N10C2
Silver-covered copper wires	-196 to 150°C	10 cm	N10C2
		30 cm	N30C2
Silver-covered copper wires	-196 to 150°C	25 mm	---

*Gage (Grid): Length × Width

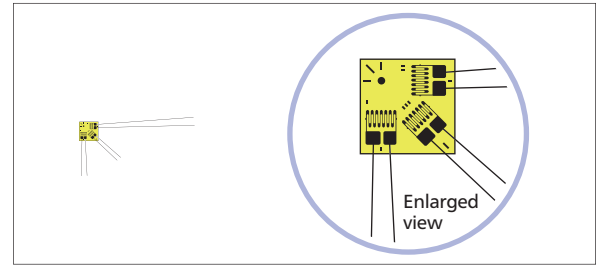
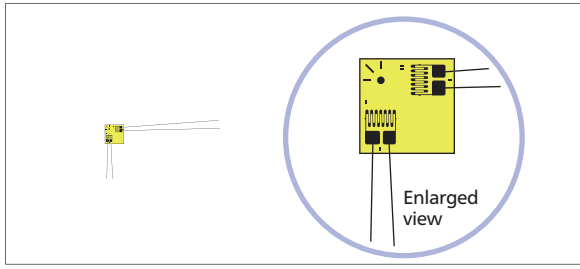

Models	KFRS-02-120-D34-13
Pattern	Biaxial, 0°/90° plane arrangement
Base	2.5 × 2.5 mm
Gage (Grid)	0.2 × 0.8 mm
Resistance	120 Ω
Pieces per Pack	5

Models	KFRS-02-120-D35-13
Pattern	Triaxial, 0°/90°/45° plane arrangement
Base	2.5 × 2.5 mm
Gage (Grid)	0.2 × 0.8 mm
Resistance	120 Ω
Pieces per Pack	5





When ordering, specify the model number as follows.

KFRS-02-120-□-13 Lead-wire Cable Code

(e.g.)

KFRS-02-120-D35-13 L1M3R

*Values in □ and lead-wire cable code cannot be arbitrarily combined.

Lead-wire Cable Type and Shape	Oprg. Temp.	Length	Code
Vinyl-coated flat 3-wire cable L-7 (L-10 for 6 m or longer) 	-10 to 80°C	1 m	L1M3R; L1M3S
		3 m	L3M3R; L3M3S
		5 m	L5M3R; L5M3S
Vinyl-coated flat 2-wire cable L-6 (L-9 for 6 m or longer) 	-10 to 80°C	1 m	L1M2R; L1M2S
		3 m	L3M2R; L3M2S
		5 m	L5M2R; L5M2S
Mid-temperature 3-wire cable L-12 	-100 to 150°C	1 m	R1M3
		3 m	R3M3
		5 m	R5M3
Mid-temperature 2-wire cable L-11 	-100 to 150°C	1 m	R1M2
		3 m	R3M2
		5 m	R5M2
3 polyester-coated copper wires	-196 to 200°C	10 cm	N10C3
		30 cm	N30C3
2 polyester-coated copper wires	-196 to 200°C	10 cm	N10C2
		30 cm	N30C2
Silver-covered copper wires	-196 to 150°C	25 mm	

*Gage (Grid): Length × Width

Strain Gages for Plastics

KFP

● Gage Factor	Approx. 2.1
● Applicable Linear Expansion Coefficients ($\times 10^{-6}/^{\circ}\text{C}$)	65
● Self-temperature-compensation Range	10 to 80°C

Applicable Adhesives and Operating Temperature Ranges

CC-33A:	-20 to 80°C
CC-35:	-20 to 80°C
CC-36:	-20 to 80°C
EP-34B:	-20 to 80°C

Foil Strain Gages for Plastics

RoHS

The KFP series foil strain gages provide an applicable linear expansion coefficient of $65 \times 10^{-6}/^{\circ}\text{C}$, which makes them suitable for strain measurement of plastics such as acrylic resin.

Types, lengths and codes of lead-wire cables pre-attached to KFP gages

Type	2 polyester-coated copper wires	3 polyester-coated copper wires	Vinyl-coated flat 2-wire cable	Vinyl-coated flat 3-wire cable
Length	C1			
15 cm	N15C2	N15C3	L15C2R	L15C3R
30 cm	N30C2	N30C3	L30C2R	L30C3R
1 m	N1M2	N1M3	L1M2R	L1M3R
3 m	—	—	L3M2R	L3M3R
5 m	—	—	L5M2R	L5M3R
Operating temp.	-20 to 80°C		-10 to 80°C	
Remarks	Twisted for ≥ 50 cm		L-6 L-9 for ≥ 6 m	L-7 L-10 for ≥ 6 m

* For other lead-wire cable lengths, contact us.

KFP ● Uniaxial

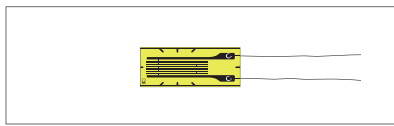

Models **KFP-5-120-C1-65**

Pattern	Uniaxial
Base	13 × 5.2 mm
Gage (Grid)	5 × 2.5 mm
Resistance	120 Ω
Pieces per Pack	10

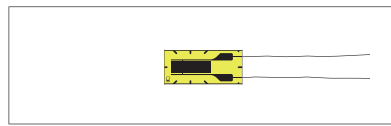

Models **KFP-2-120-C1-65**

Pattern	Uniaxial
Base	10 × 4.7 mm
Gage (Grid)	2 × 2 mm
Resistance	120 Ω
Pieces per Pack	10

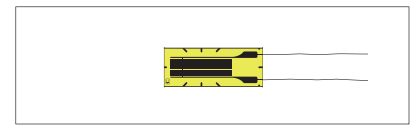

Models **KFP-5-350-C1-65**

Pattern	Uniaxial
Base	13 × 5.2 mm
Gage (Grid)	5 × 2.6 mm
Resistance	350 Ω
Pieces per Pack	10

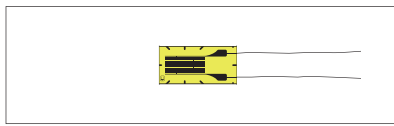

Models **KFP-2-350-C1-65**

Pattern	Uniaxial
Base	10 × 5.2 mm
Gage (Grid)	2 × 2.4 mm
Resistance	350 Ω
Pieces per Pack	10

When ordering, specify the model number as follows.

KFP-□-□-C1-65 Lead-wire Cable Code

(e.g.)

KFP-5-120-C1-65 L1M3R

*Values in □ and lead-wire cable code cannot be arbitrarily combined.

Lead-wire Cable Type and Shape	Oprg. Temp.	Length	Code
Vinyl-coated flat 3-wire cable L-7 (L-10 for 6 m or longer)	-10 to 80°C	1 m	L1M3R
		3 m	L3M3R
		5 m	L5M3R
Vinyl-coated flat 2-wire cable L-6 (L-9 for 6 m or longer)	-10 to 80°C	1 m	L1M2R
		3 m	L3M2R
		5 m	L5M2R
3 polyester-coated copper wires	-20 to 80°C	30 cm	N30C3
		50 cm	N50C3
		50 cm, 1 m	N1M3
2 polyester-coated copper wires	-20 to 80°C	30 cm	N30C2
		50 cm	N50C2
		50 cm, 1 m	N1M2
Silver-covered copper wires	-20 to 80°C	25 mm	

*Gage (Grid): Length × Width

Strain Gages for Ultra-small Strain Measurements

KSPB

RoHS

● Gage Factor	Approx. 125, 160, 170, 235
● Applicable Linear Expansion Coefficients ($\times 10^{-6}/^{\circ}\text{C}$)	11
● Self-temperature-compensation Range	20 to 50°C*

*KSPB-3-120-F2-11 only

Applicable Adhesives and Operating Temperature Ranges

CC-33A: -50 to 120°C
EP-340: -50 to 150°C

Semiconductor Strain Gages

The KSPB series gages are stable-performance semiconductor strain gages usable for general stress measurement and transducers. The F2 type has a half-bridge formed with a 2-element structure (Positive and Negative), for self-temperature compensation and is suitable for strain measurement of steel products.

KSPB ● Uniaxial, Uniaxial 2-element

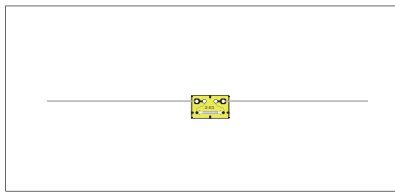

KSPB-2-120-E3

Models	KSPB-2-120-E3
Pattern	Uniaxial
Gage Factor	Approx. 125
Base	5 × 3 mm
Gage (Grid)	2 × 0.25 mm
Resistance	120 Ω
Pieces per Pack	4

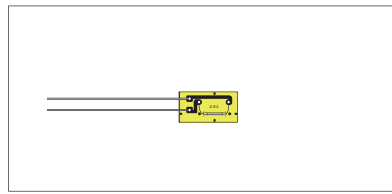

KSPB-2-120-E4

Models	KSPB-2-120-E4
Pattern	Uniaxial
Gage Factor	Approx. 125
Base	7.7 × 4 mm
Gage (Grid)	2 × 0.26 mm
Resistance	120 Ω
Pieces per Pack	4

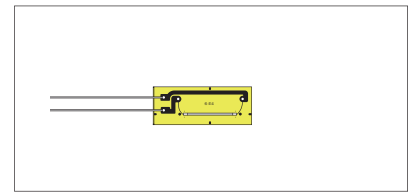

KSPB-6-350-E4

Models	KSPB-6-350-E4
Pattern	Uniaxial
Gage Factor	Approx. 125
Base	13 × 5 mm
Gage (Grid)	6 × 0.27 mm
Resistance	350 Ω
Pieces per Pack	4

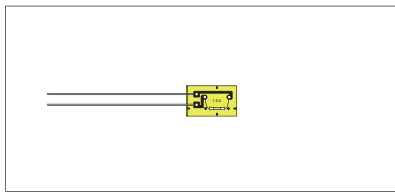

KSPB-1-350-E4

Models	KSPB-1-350-E4
Pattern	Uniaxial
Gage Factor	Approx. 160
Applicable Linear Expansion Coefficients	—
Self-temperature-compensation Range	—
Base	6.6 × 4 mm
Gage (Grid)	1 × 0.25 mm
Resistance	350 Ω
Pieces per Pack	4

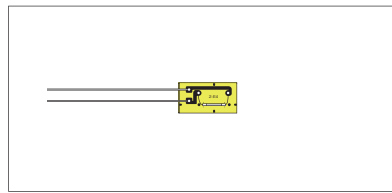

KSPB-2-1K-E4

Models	KSPB-2-1K-E4
Pattern	Uniaxial
Gage Factor	Approx. 170
Applicable Linear Expansion Coefficients	—
Self-temperature-compensation Range	—
Base	7.7 × 4 mm
Gage (Grid)	2 × 0.2 mm
Resistance	1000 Ω
Pieces per Pack	4

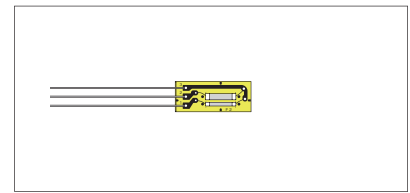

KSPB-3-120-F2-11

Models	KSPB-3-120-F2-11
Pattern	Uniaxial 2-element
Gage Factor	Approx. 235
Applicable Linear Expansion Coefficients	11
Self-temperature-compensation Range	20 to 70°C
Base	10 × 4 mm
Gage (Grid)	N: 3 × 0.83 mm P: 3 × 0.47 mm
Resistance	120 Ω
Pieces per Pack	2

When ordering,
specify the model number as follows.

KSPB-□-□-□-□

(e.g.) KSPB-2-120-E3

*Values in □ and lead-wire cable code cannot be arbitrarily combined.

Lead-wire Cable Type and Shape	Oprg. Temp.	Length
Silver-covered copper wire	-50 to 150°C	25 mm
Silver-covered copper wires	-50 to 150°C	25 mm
Silver-covered copper wires	-50 to 150°C	25 mm

*Gage (Grid): Length × Width

Strain Gages for Ultra-small Strain Measurements

KSNB

● Gage Factor	Approx. -100, -110
● Applicable Linear Expansion Coefficients ($\times 10^{-6}/^{\circ}\text{C}$)	11, 16
● Self-temperature-compensation Range	20 to 50°C

Applicable Adhesives and Operating Temperature Ranges
 EP-340: -50 to 150°C
 CC-33A: -50 to 120°C
 CC-36: -30 to 100°C

Self-temperature-compensation Semiconductor Strain Gages



The KSNB series gages use an N-type silicon as the resistive element to control the resistance temperature coefficient of the material according to the linear expansion coefficient of the measuring object. Thus, the change of thermally-induced resistance is minimized. (Excluding E5)

KSNB ● Uniaxial, Biaxial

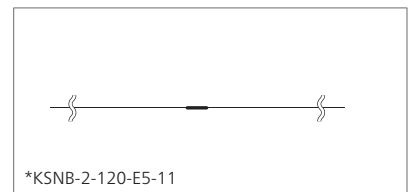
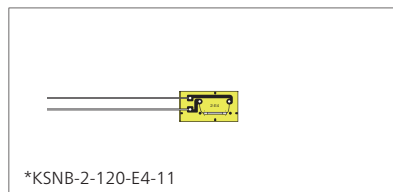
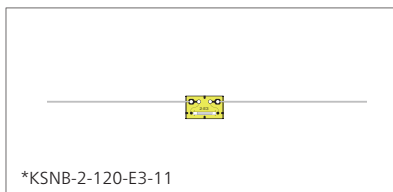

Models	KSNB-2-120-E3-	11 16	KSNB-2-120-E4-	11 16	KSNB-2-120-E5-	11 16
Pattern	Uniaxial		Uniaxial		Uniaxial	
Gage Factor	Approx. -100		Approx. -100		Approx. -110	
Base	5 × 3 mm		7.7 × 4 mm		—	
Gage (Grid)	2 × 0.3 mm		2 × 0.3 mm		2 × 0.3 mm	
Resistance	120 Ω		120 Ω		120 Ω	
Pieces per Pack	4		4		4	

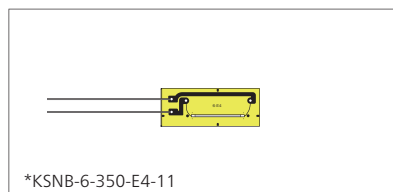
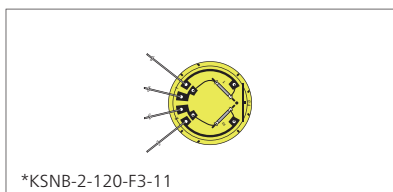

Models	KSNB-2-120-F3-	11 16	KSNB-6-350-E4-	11 16
Pattern	Biaxial, 0°/90°		Uniaxial	
Gage Factor	Approx. -100		Approx. -100	
Base	φ11		13 × 5 mm	
Gage (Grid)	2 × 0.3 mm		6 × 0.31 mm	
Resistance	120 Ω		350 Ω	
Pieces per Pack	2		4	

When ordering, specify the model number as follows.



e.g. KSNB-2-120-E3-11

*Values in □ and lead-wire cable code cannot be arbitrarily combined.

Lead-wire Cable Type and Shape	Oprg. Temp.	Length
Silver-covered copper wire	-50 to 150°C	25 mm
Silver-covered copper wires	-50 to 150°C	25 mm
Oxygen-free tin-plated copper wires (Only E5)	-50 to 150°C	40 mm

*Gage (Grid): Length × Width

Strain Gages for Ultra-small Strain Measurements

KSPH

● Gage Factor Approx. 170

Applicable Adhesives and
Operating Temperature Ranges
CC-33A: -50 to 120°C
CC-36: -30 to 100°C

■ High-output Semiconductor Strain Gages

The KSPH series gages have high resistance, thereby making high excitation voltage applicable to obtain high output voltage.

KSPH ● Uniaxial

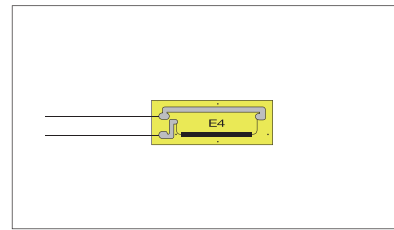
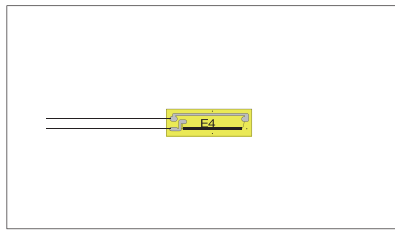

Models	KSPH-4-2K-E4
Pattern	Uniaxial
Base	11 × 4 mm
Gage (Grid)	4 × 0.73 mm
Resistance	2000 Ω
Pieces per Pack	4

Models	KSPH-9-10K-E4
Pattern	Uniaxial
Base	16 × 5 mm
Gage (Grid)	9 × 0.58 mm
Resistance	10000 Ω
Pieces per Pack	4

When ordering,
specify the model number as follows.

KSPH-□-□K-E4

(e.g.) KSPH-4-2K-E4

*Values in □ and lead-wire cable code cannot be arbitrarily combined.

Lead-wire Cable Type and Shape	Oprg. Temp.	Length
Silver-covered copper wires	-50 to 150°C	25 mm

*Gage (Grid): Length × Width

Strain Gages for Ultra-small Strain Measurements

KSPLB

● Gage Factor Approx. 90

Applicable Adhesives and
Operating Temperature Ranges
CC-33A: -50 to 120°C
EP-340: -50 to 150°C

■ **Ultra Linear** **RoHS** **NEW**
Semiconductor Strain Gage
The KSPLB gage features a superior
linearity of resistance change against strain
in a comparatively wide range, thereby
making it suitable as a sensing element of
transducers.

KSPLB ● Uniaxial

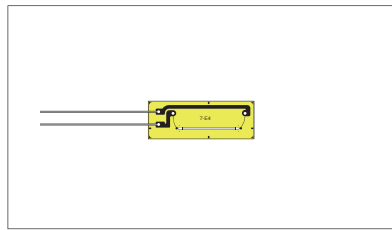

Models	KSPLB-7-60-E4
Pattern	Uniaxial
Base	14 × 5 mm
Gage (Grid)	7 × 0.28 mm
Resistance	60 Ω
Pieces per Pack	4

When ordering,
specify the model number as follows.

KSPLB-7-60-E4

Lead-wire Cable Type and Shape	Oprg. Temp.	Length
Silver-covered copper wires	-50 to 150°C	25 mm

*Gage (Grid): Length × Width

High-temperature Gages

KFU

RoHS

● Gage Factor	Approx. 2.0 Approx. 1.85 at 350 °C (Reference value)
● Applicable Linear Expansion Coefficients (x10 ⁻⁶ /°C)	11, 16, 23
● Self-temperature-compensation Range	10 to 300°C

Applicable Adhesives and Operating Temperature Ranges
PI-32: -30 to 350°C

High-temperature Foil Strain Gages

The base is made of highly heat-resistant polyimide and the gage element is made of NiCr alloy foil, thereby letting the KFU series gage exhibit superior characteristics over a wide temperature range.
*Please use KFU for short period testing.
E.g. 72 hours or less at 350°C, 360 hours or less at 300°C, adhesive PI-32 (It changes depending on the condition.)

Types, lengths and codes of lead-wire cables pre-attached to KFU gages

Type	High/low-temp. 3-wire cable
Length	C1, D16, D17
15 cm	H15C3
30 cm	H30C3
1 m	H1M3
3 m	H3M3
5 m	H5M3
Operating temp.	-30 to 350°C
Remarks	L-17*

* For type H of lead-wire cable with glass-cloth tape, see page 23.

** For other lead-wire cable lengths, contact us.

KFU ● Uniaxial, Biaxial

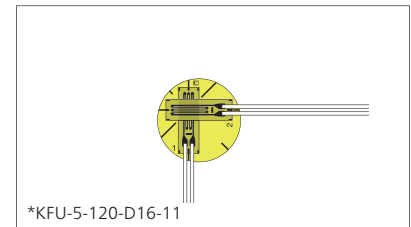
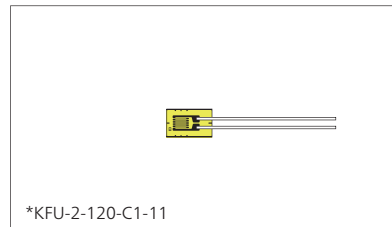
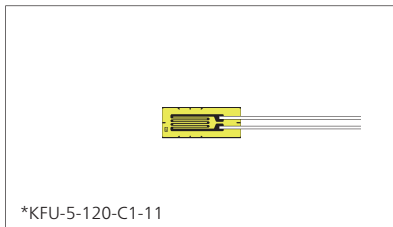

Models	KFU-5-120-C1-	11 16 23	KFU-2-120-C1-	11 16 23	KFU-5-120-D16-	11 16 23
Pattern	Uniaxial		Uniaxial		Biaxial, 0°/90° stacked rosette	
Base	10 × 3.7 mm		6 × 3.7 mm		φ 11	
Gage (Grid)	5 × 2.5 mm		2 × 2.5 mm		5 × 1.4 mm	
Resistance	120 Ω		120 Ω		120 Ω	
Pieces per Pack	10		10		10	

When ordering, specify the model number as follows.

KFU-□-□-□-□ Lead-wire Cable Code

e.g.) KFU-5-120-C1-11 H1M3

*Values in □ and lead-wire cable code cannot be arbitrarily combined.

Lead-wire Cable Type and Shape	Oprg. Temp.	Length	Code
High/low temp. 3-wire cable L-17 	-196 to 350°C	1 m	H1M3
		3 m	H3M3
		5 m	H5M3
Advanced ribbon cable 	-196 to 350°C	25 mm	

*Gage (Grid): Length × Width

KFU ● Uniaxial, Biaxial, Triaxial

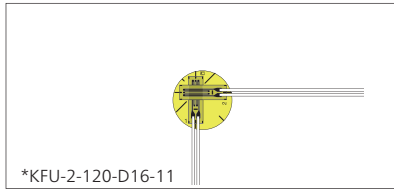

*KFU-2-120-D16-11

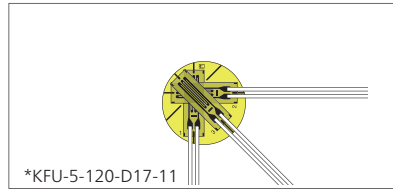

*KFU-5-120-D17-11

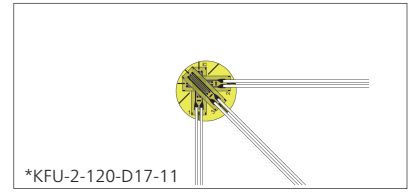

*KFU-2-120-D17-11

Models	KFU-2-120-D16-	11 16 23	KFU-5-120-D17-	11 16 23	KFU-2-120-D17-	11 16 23
Pattern	Biaxial, 0°/90° stacked rosette		Triaxial, 0°/45°/90° stacked rosette		Triaxial, 0°/45°/90° stacked rosette	
Base	φ8		φ11		φ8	
Gage (Grid)	2 × 1.2 mm		5 × 1.4 mm		2 × 1.2 mm	
Resistance	120 Ω		120 Ω		120 Ω	
Pieces per Pack	10		10		10	

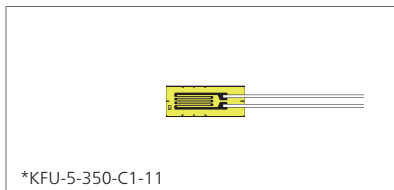

*KFU-5-350-C1-11

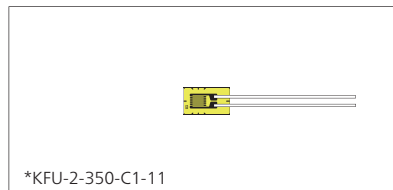

*KFU-2-350-C1-11

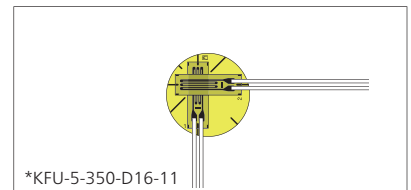

*KFU-5-350-D16-11

Models	KFU-5-350-C1-	11 16 23	KFU-2-350-C1-	11 16 23	KFU-5-350-D16-	11 16 23
Pattern	Uniaxial		Uniaxial		Biaxial, 0°/90° stacked rosette	
Base	10 × 3.7 mm		6 × 3.7 mm		φ11	
Gage (Grid)	5 × 2.4 mm		2 × 2.4 mm		5 × 2 mm	
Resistance	350 Ω		350 Ω		350 Ω	
Pieces per Pack	10		10		10	

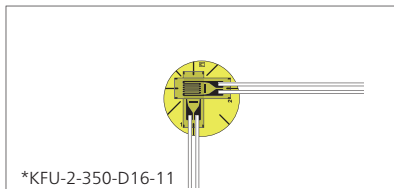

*KFU-2-350-D16-11

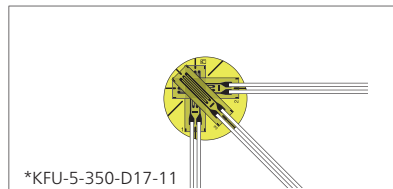

*KFU-5-350-D17-11

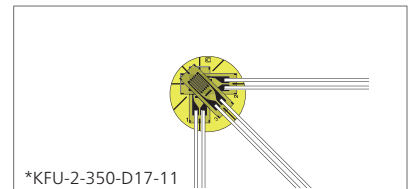

*KFU-2-350-D17-11



Models	KFU-2-350-D16-	11 16 23	KFU-5-350-D17-	11 16 23	KFU-2-350-D17-	11 16 23
Pattern	Biaxial, 0°/90° stacked rosette		Triaxial, 0°/45°/90° stacked rosette		Triaxial, 0°/45°/90° stacked rosette	
Base	φ10		φ11		φ10	
Gage (Grid)	2 × 2 mm		5 × 2 mm		2 × 2 mm	
Resistance	350 Ω		350 Ω		350 Ω	
Pieces per Pack	10		10		10	

When ordering, specify the model number as follows.

KFU-□-□-□-□ **Lead-wire Cable Code**

Ⓜ KFU-5-350-C1-11 H1M3

*Values in □ and lead-wire cable code cannot be arbitrarily combined.

Lead-wire Cable Type and Shape	Oprg. Temp.	Length	Code
 High/low temp. 3-wire cable L-17	-196 to 350°C	1 m	H1M3
		3 m	H3M3
		5 m	H5M3
 Advanced ribbon cable	-196 to 350°C	25 mm	

*Gage (Grid): Length × Width

High-temperature Gages

KH

RoHS

● Gage Factor	Approx. 2.0 (350°C)
● Applicable Linear Expansion Coefficients ($\times 10^{-6}/^{\circ}\text{C}$)	11, 16
● Self-temperature-compensation Range	10 to 300°C

Applicable Adhesives and Operating Temperature Ranges
Spot welding: -50 to 350°C

High-temperature Foil Strain Gages

The KH gages are 350 Ω gages with a metal base which enables easy mounting with a compact spot welder.

*Operating time (Depends on usage conditions)
24 hours or less at 350°C
72 hours or less at 300°C

Types, lengths and codes of lead-wire cables pre-attached to KH gages

Type	Glass-coated Ni-plated 3-wire copper cable
Length	G4
15 cm	D15C3
30 cm	D30C3
1 m	D1M3
3 m	D3M3
5 m	D5M3
Operating temp.	-50 to 350°C

* For other lead-wire cable lengths, contact us.

KH ● Uniaxial

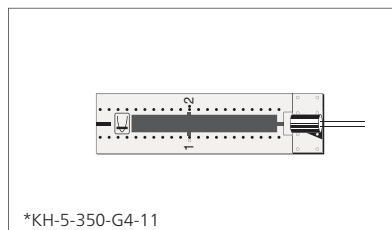

*KH-5-350-G4-11

Models	KH-5-350-G4-	11 16
Pattern	Uniaxial	
Base	30 × 8 mm	
Gage (Grid)	5 × 1 mm	
Resistance	350 Ω	
Pieces per Pack	5	

When ordering, specify the model number as follows.

KH-5-350-G4- **Lead-wire Cable Code**

e.g.) KH-5-350-G4-11 D1M3

*Values in and lead-wire cable code cannot be arbitrarily combined.

Lead-wire Cable Type and Shape	Oprg. Temp.	Length	Code
Glass-coated Ni-plated 3-wire copper cable 	-50 to 350°C	1 m	D1M3
		3 m	D3M3
		5 m	D5M3
Advanced cable 	-50 to 350°C	25 mm	

*Gage (Grid): Length × Width

High-temperature Gages

KFHB

- Gage Factor Approx. 2.0
Approx. 1.9 at 250 °C (Reference value)
- Applicable Linear Expansion Coefficients ($\times 10^{-6}/^{\circ}\text{C}$) 11, 16, 23
- Self-temperature-compensation Range 10 to 250°C

Applicable Adhesives

	Operating temperature after curing the adhesive
PC-600, PI-32	-196 to 250°C
EP-34B	-55 to 200°C

Operating Time

End of the model	250°C	200°C
11	24 hours	120 hours
16	12 hours	120 hours
23	12 hours	120 hours

High-temperature Foil Strain Gages

RoHS

The base is made of highly heat-resistant polyimide and the gage element is made of NiCr alloy foil, thereby ensuring less thermal output and excellent temperature characteristics.

Types, lengths and codes of lead-wire cables pre-attached to KFHB gages

Type	High/low-temp. 3-wire cable	Fluoroplastic-coated high/low-temp. 3-wire cable
Length	C1, D25	
15 cm	H15C3	F15C3
30 cm	H30C3	F30C3
1 m	H1M3	F1M3
3 m	H3M3	F3M3
5 m	H5M3	F5M3
Operating temp.	-196 to 250°C	-196 to 250°C
Remarks	L-17*	L-3*

* For type H and type F of lead-wire cables with glass-cloth tape, see page 23.

** For other lead-wire cable lengths, contact us.

KFHB ● Uniaxial

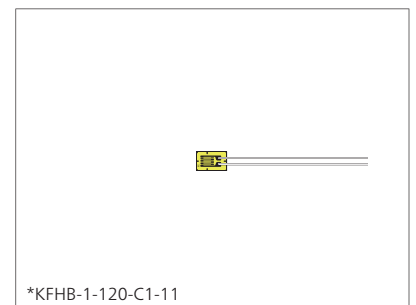
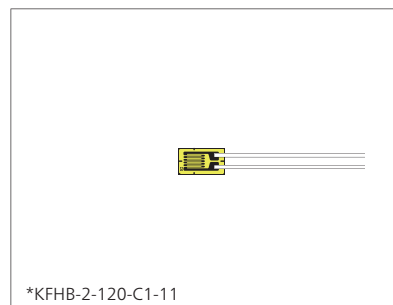
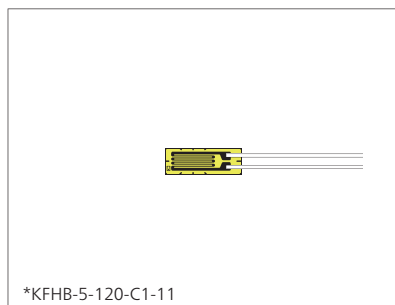

Models	KFHB-5-120-C1- 11 16 23	KFHB-2-120-C1- 11 16 23	KFHB-1-120-C1- 11 16 23
Pattern	Uniaxial		
Base	10 × 3.7 mm	6 × 3.7 mm	4 × 2.7 mm
Gage (Grid)	5 × 2.5 mm	2 × 2.5 mm	1 × 1.5 mm
Resistance	120 Ω		
Pieces per Pack	10		

KFHB ● Uniaxial, Triaxial

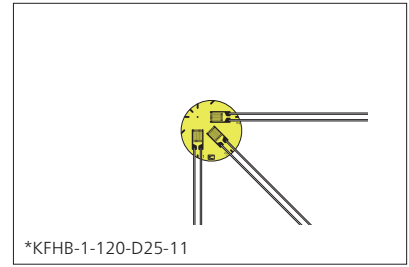
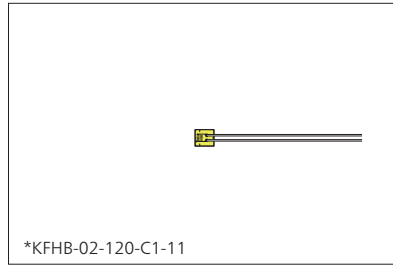
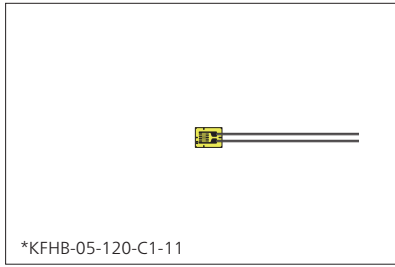

Models	KFHB-05-120-C1-	11 16 23	KFHB-02-120-C1-	11 16 23	KFHB-1-120-D25-	11 16 23
Pattern	Uniaxial		Uniaxial		Triaxial, 0°/90°/45°	
Base	3.3 × 2.7 mm		2.5 × 2.2 mm		φ8	
Gage (Grid)	0.5 × 1.4 mm		0.2 × 1 mm		1 × 1.5 mm	
Resistance	120 Ω		120 Ω		120 Ω	
Pieces per Pack	10		10		5	

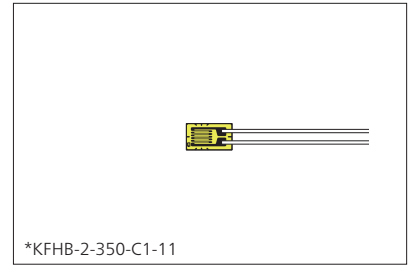
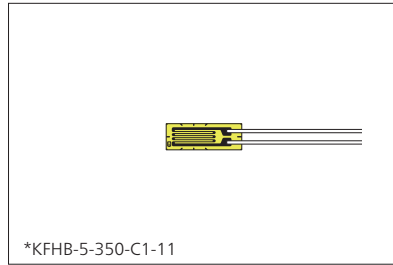
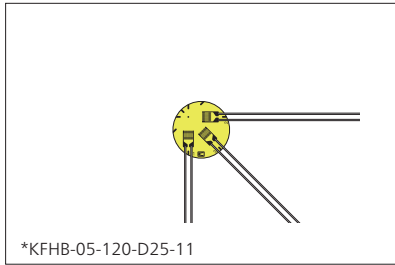

Models	KFHB-05-120-D25-	11 16 23	KFHB-5-350-C1-	11 16 23	KFHB-2-350-C1-	11 16 23
Pattern	Triaxial, 0°/90°/45°		Uniaxial		Uniaxial	
Base	φ7.5		10 × 3.7 mm		6 × 3.7 mm	
Gage (Grid)	0.5 × 1.4 mm		5 × 2.4 mm		2 × 2.4 mm	
Resistance	120 Ω		350 Ω		350 Ω	
Pieces per Pack	5		10		10	

When ordering, specify the model number as follows.

KFHB-□-□-□-□ Lead-wire Cable Code

(e.g.)

KFHB-5-120-C1-11 H1M3

*Values in □ and lead-wire cable code cannot be arbitrarily combined.

Lead-wire Cable Type and Shape	Oprg. Temp.	Length	Code
High/low temp. 3-wire cable L-17 	-196 to 250°C	1 m	H1M3
		3 m	H3M3
		5 m	H5M3
Fluoroplastic-coated high/low temp. 3-wire cable L-3 	-196 to 250°C	1 m	F1M3
		3 m	F3M3
		5 m	F5M3
Advanced ribbon cable 	-196 to 250°C	25 mm	

*Gage (Grid): Length × Width

KFHB ● Uniaxial, Triaxial

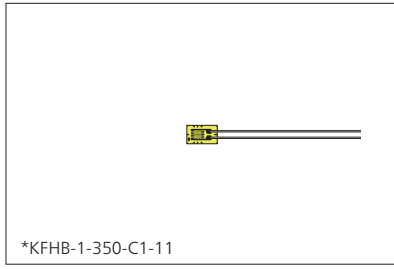

*KFHB-1-350-C1-11

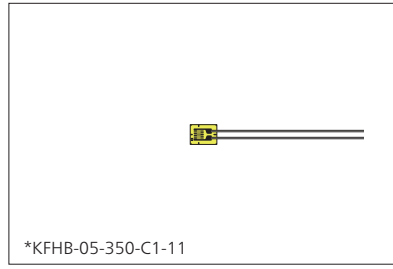

*KFHB-05-350-C1-11

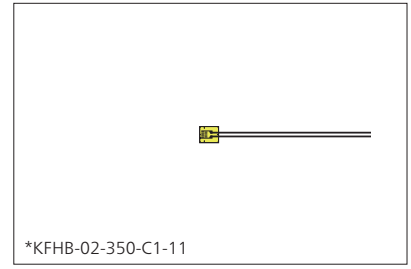

*KFHB-02-350-C1-11

Models	KFHB-1-350-C1-	11 16 23	KFHB-05-350-C1-	11 16 23	KFHB-02-350-C1-	11 16 23
Pattern	Uniaxial		Uniaxial		Uniaxial	
Base	4 × 2.7 mm		3.5 × 2.7 mm		3.0 × 2.7 mm	
Gage (Grid)	1 × 1.5 mm		0.5 × 1.5 mm		0.2 × 1.5 mm	
Resistance	350 Ω		350 Ω		350 Ω	
Pieces per Pack	10		10		10	

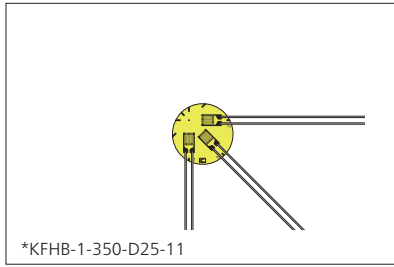

*KFHB-1-350-D25-11

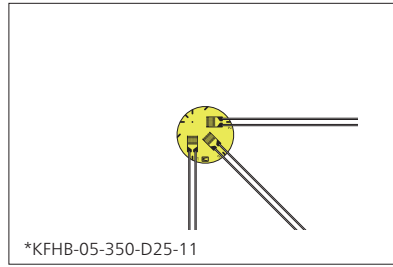

*KFHB-05-350-D25-11

Models	KFHB-1-350-D25-	11 16 23	KFHB-05-350-D25-	11 16 23
Pattern	Triaxial, 0°/90°/45°		Triaxial, 0°/90°/45°	
Base	φ8		φ7.5	
Gage (Grid)	1 × 1.5 mm		0.5 × 1.5 mm	
Resistance	350 Ω		350 Ω	
Pieces per Pack	5		5	

When ordering, specify the model number as follows.

KFHB-□-350-□-□ Lead-wire Cable Code

(e.g.)

KFHB-1-350-C1-11 H1M3

*Values in □ and lead-wire cable code cannot be arbitrarily combined.

Lead-wire Cable Type and Shape	Oprg. Temp.	Length	Code
High/low temp. 3-wire cable L-17 	-196 to 250°C	1 m	H1M3
		3 m	H3M3
		5 m	H5M3
Fluoroplastic-coated high/low temp. 3-wire cable L-3 	-196 to 250°C	1 m	F1M3
		3 m	F3M3
		5 m	F5M3
Advanced ribbon cable 	-196 to 250°C	25 mm	

*Gage (Grid): Length × Width

Low-temperature Gages

KFLB

● Gage Factor	Approx. 2.0
● Applicable Linear Expansion Coefficients (x10 ⁻⁶ /°C)	5, 11, 16, 23
● Self-temperature-compensation Range	-196 to 50°C

Applicable Adhesives and Operating Temperature Ranges

PC-600: -269 to 150°C
 CC-33A: -196 to 120°C
 EP-270: -269 to 30°C

Low-temperature Foil Strain Gages

RoHS

The gage element is made of NiCr alloy, which exhibits excellent characteristics under low-temperature environments and is sandwiched between polyimide films. Thus, the KFLB series gages are suitable for strain measurement of tanks and vessels containing low-temperature liquids such as LNG and LPG.

Types, lengths and codes of lead-wire cables pre-attached to KFLB series gages

Type	2 polyester-coated copper wires	3 polyester-coated copper wires	Mid-temperature. 2-wire cable	Mid-temperature. 3-wire cable	Fluoroplastic-coated high/low-temp. 3-wire cable
Length	C1, D25				
15 cm	N15C2	N15C3	R15C2	R15C3	F15C3
30 cm	N30C2	N30C3	R30C2	R30C3	F30C3
1 m	N1M2	N1M3	R1M2	R1M3	F1M3
3 m	—	—	R3M2	R3M3	F3M3
5 m	—	—	R5M2	R5M3	F5M3
Operating temp.	-196 to 150°C		-100 to 150°C		-196 to 150°C*
Remarks	Twisted for ≥ 50 cm		L-11**	L-12**	L-3**

* -196°C: Because the gage leads are polyester-coated copper wires.

** For type R and type F of lead-wire cable with glass-cloth tape, see page 23.

*** For other lead-wire cable lengths, contact us.

KFLB ● Uniaxial

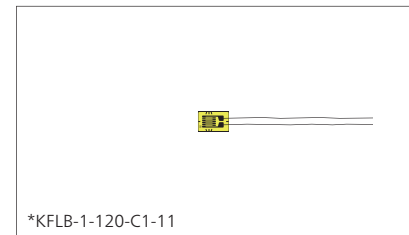
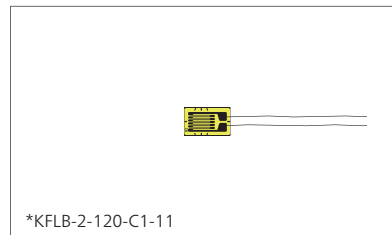
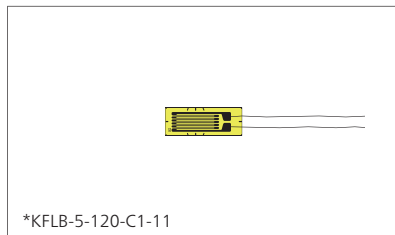

Models	KFLB-5-120-C1-	11 16 23	KFLB-2-120-C1-	11 16 23	KFLB-1-120-C1-	11 16 23
Pattern	Uniaxial		Uniaxial		Uniaxial	
Base	10 × 3.7 mm		6 × 3.7 mm		4 × 2.7 mm	
Gage (Grid)	5 × 2.5 mm		2 × 2.5 mm		1 × 1.5 mm	
Resistance	120 Ω		120 Ω		120 Ω	
Pieces per Pack	10		10		10	

When ordering, specify the model number as follows.

KFLB-□-120-C1-□ Lead-wire Cable Code

e.g.

KFLB-5-120-C1-11 F1M3

*Values in □ and lead-wire cable code cannot be arbitrarily combined.

Lead-wire Cable Type and Shape	Oprg. Temp.	Length	Code
Fluoroplastic-coated high/low temp. 3-wire cable L-3	-269 to 150°C	1 m	F1M3
		3 m	F3M3
		5 m	F5M3
Mid-temperature 3-wire cable L-12	-100 to 150°C	1 m	R1M3
		3 m	R3M3
		5 m	R5M3
Mid-temperature 2-wire cable L-11	-100 to 150°C	1 m	R1M2
		3 m	R3M2
		5 m	R5M2
3 polyester-coated copper wires	-196 to 150°C	30 cm	N30C3
		50 cm, 1 m	N50C3
		1 m	N1M3
2 polyester-coated copper wires	-196 to 150°C	30 cm	N30C2
		50 cm, 1 m	N50C2
		1 m	N1M2
Silver-covered copper wires	-269 to 150°C	25 mm	

*Gage (Grid): Length × Width

KFLB ● Uniaxial, Triaxial

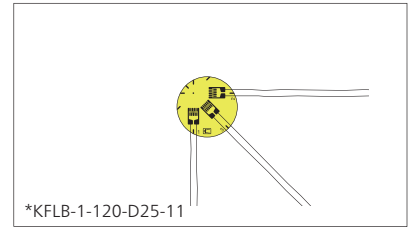
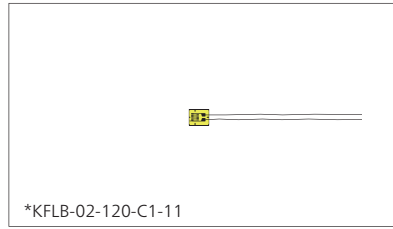
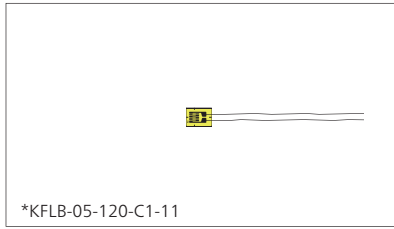

Models	KFLB-05-120-C1-	11 16 23	KFLB-02-120-C1-	11 16 23	KFLB-1-120-D25-	11 16 23
Pattern	Uniaxial		Uniaxial		Triaxial, 0°/90°/45°	
Base	3.3 × 2.7 mm		2.5 × 2.2 mm		φ8	
Gage (Grid)	0.5 × 1.4 mm		0.2 × 1 mm		1 × 1.5 mm	
Resistance	120 Ω		120 Ω		120 Ω	
Pieces per Pack	10		10		5	

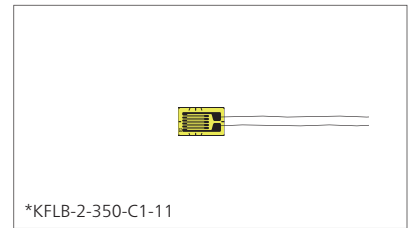
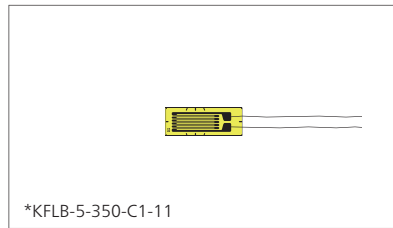
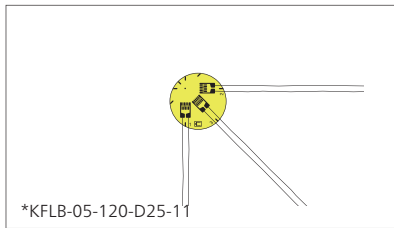

Models	KFLB-05-120-D25-	11 16 23	KFLB-5-350-C1-	11 16 23	KFLB-2-350-C1-	11 16 23
Pattern	Triaxial, 0°/90°/45°		Uniaxial		Uniaxial	
Base	φ7.5		10 × 3.7 mm		6 × 3.7 mm	
Gage (Grid)	0.5 × 1.4 mm		5 × 2.4 mm		2 × 2.4 mm	
Resistance	120 Ω		350 Ω		350 Ω	
Pieces per Pack	5		10		10	

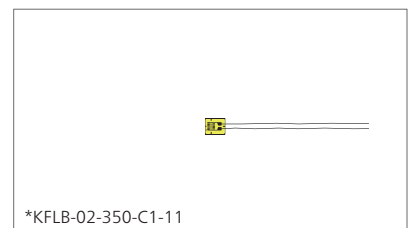
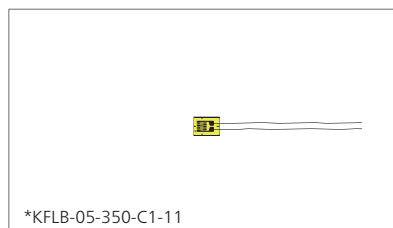
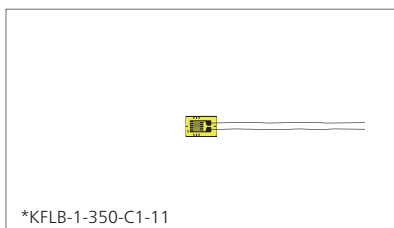

Models	KFLB-1-350-C1-	11 16 23	KFLB-05-350-C1-	11 16 23	KFLB-02-350-C1-	11 16 23
Pattern	Uniaxial		Uniaxial		Uniaxial	
Base	4 × 2.7 mm		3.5 × 2.7 mm		3 × 2.7 mm	
Gage (Grid)	1 × 1.5 mm		0.5 × 1.5 mm		0.2 × 1.5 mm	
Resistance	350 Ω		350 Ω		350 Ω	
Pieces per Pack	10		10		10	

KFLB ● Triaxial, Uniaxial for concrete and lumber

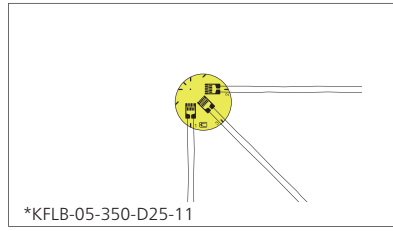
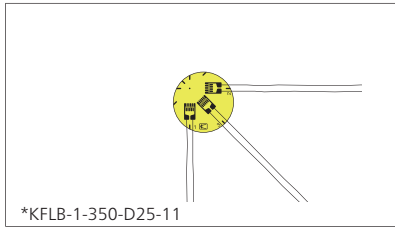

Models	KFLB-1-350-D25-	11	KFLB-05-350-D25-	11
		16		16
		23		23
Pattern	Triaxial, 0°/90°/45°		Triaxial, 0°/90°/45°	
Base	φ8		φ7.5	
Gage (Grid)	1 × 1.5 mm		0.5 × 1.5 mm	
Resistance	350 Ω		350 Ω	
Pieces per Pack	5		5	

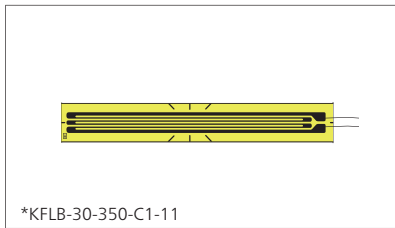

Models	KFLB-30-350-C1-	5
		11
Pattern	Uniaxial (For concrete and lumber)	
Base	36 × 5.2 mm	
Gage (Grid)	30 × 2.7 mm	
Resistance	350 Ω	
Applicable Linear Expansion Coefficients	5 (lumber) 11 (concrete)	
Pieces per Pack	10	

When ordering, specify the model number as follows.

KFLB-□-350-□-□ Lead-wire Cable Code

e.g.

KFLB-5-350-C1-11 F1M3

*Values in □ and lead-wire cable code cannot be arbitrarily combined.

Lead-wire Cable Type and Shape	Oprg. Temp.	Length	Code
Fluoroplastic-coated high/low temp. 3-wire cable L-3	-269 to 150°C	1 m	F1M3
		3 m	F3M3
		5 m	F5M3
Mid-temperature 3-wire cable L-12	-100 to 150°C	1 m	R1M3
		3 m	R3M3
		5 m	R5M3
Mid-temperature 2-wire cable L-11	-100 to 150°C	1 m	R1M2
		3 m	R3M2
		5 m	R5M2
3 polyester-coated copper wires	-196 to 150°C	30 cm	N30C3
		50 cm, 1 m	N50C3
		1 m	N1M3
2 polyester-coated copper wires	-196 to 150°C	30 cm	N30C2
		50 cm, 1 m	N50C2
		1 m	N1M2
Silver-covered copper wires	-269 to 150°C	25 mm	

*Gage (Grid): Length × Width

High-elongation Strain Gages

KFEM

RoHS

● Resistance	120 Ω
● Gage Factor	Approx. 2.0
● Operating Temperature Range	-20 to 80°C
● Strain Limit at Room Temperature	20% to 30%
● Applicable Adhesive	CC-36

■ Ultrahigh-elongation Foil Strain Gages

KFEM series ultrahigh-elongation foil gages allow strain to be measured on various regions of structures, from elastic to plastic, and are suitable for large strain measurement. They can measure 20% to 30% of material deformation.

*Strain limit of 20% to 30% is ensured for simple tension applied to the gage bonded on stainless steel (SUS 304) or aluminum alloy (A1050) at normal temperature.

*Strain limit will be decreased under the following conditions.

- In case of bonding to non-adhesive materials such as aluminum alloy (A7075) and plastics (Polypropylene)
- In case of the targets have discontinuous distortion, or any crack on its surface
- In case of measurement at high/low temperature.

- Measurement of 20% to 30% material deformation possible
- Laminate protruding from the tip of gage base ensures improved adhesive property, making the gages hard to peel off.
- Foil material has an improved elongation property and is hard to disconnect.

■ Types, lengths and codes of lead-wire cables pre-attached to KFEM gages

Type	2 polyester-coated copper wires	Vinyl-coated flat 2-wire cable	Vinyl-coated flat 3-wire cable
Length	C1		
15 cm	N15C2	L15C2R	L15C3R
30 cm	N30C2	L30C2R	L30C3R
1 m	N1M2	L1M2R	L1M3R
3 m	—	L3M2R	L3M3R
5 m	—	L5M2R	L5M3R
Operating temp.	-20 to 80°C	-10 to 80°C	
Remarks	Twisted for ≥ 50 cm	L-6 L-9 for ≥ 6 m	L-7 L-10 for ≥ 6 m

* For other lead-wire cable lengths, contact us.

KFEM ● Uniaxial

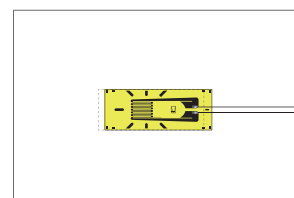
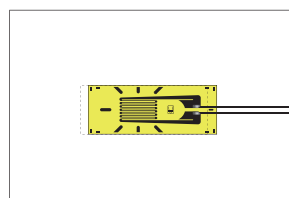
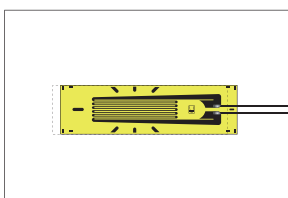
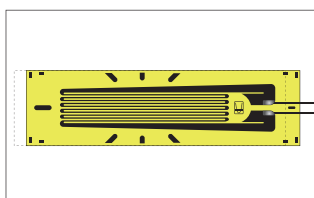

Models	KFEM-10-120-C1	KFEM-5-120-C1	KFEM-2-120-C1	KFEM-1-120-C1
Pattern	Uniaxial			
Base	17.5 × 4.5 mm	11.5 × 3 mm	8.5 × 3 mm	7.0 × 2.5 mm
Gage (Grid)	10 × 2.5 mm	5 × 1.5 mm	2 × 1.5 mm	1 × 1.3 mm
Resistance	120 Ω			
Pieces per Pack	10			

When ordering, specify the model number as follows.

KFEM-□-120-C1 Lead-wire Cable Code

(e.g.) KFEM-2-120-C1

*Values in □ and lead-wire cable code cannot be arbitrarily combined.

Lead-wire Cable Type and Shape	Oprg. Temp.	Length	Code
Vinyl-coated flat 3-wire cable L-7 (L-10 for 6 m or longer)	-10 to 80°C	1 m	L1M3R
		3 m	L3M3R
		5 m	L5M3R
Vinyl-coated flat 2-wire cable L-6 (L-9 for 6 m or longer)	-10 to 80°C	1 m	L1M2R
		3 m	L3M2R
		5 m	L5M2R
2 polyester-coated copper wires	-20 to 80°C	30 cm	N30C2
		50 cm	N50C2
		1 m	N1M2
Silver-covered copper wires	-20 to 80°C	25 mm	

*Gage (Grid): Length × Width

High-elongation Strain Gages

KFEL

● Gage Factor	Approx. 2.1
● Resistance	120Ω
● Strain Limit at Room Temperature	10% to 15%

Applicable Adhesives and Operating Temperature Ranges
CC-36: -10 to 80°C

High-elongation Foil Strain Gages

RoHS

Developed to measure strain in elastic to plastic regions on structures, the KFEL gages can measure strain as large as 10% to 15% with simple tension strain.

Types, lengths and codes of lead-wire cables pre-attached to KFEL gages

Type	2 polyester-coated copper wires	Vinyl-coated flat 2-wire cable		Vinyl-coated flat 3-wire cable	
Length	C1, D34, D35	C1	D34, D35	C1	D34, D35
15 cm	N15C2	L15C2R	L15C2S	L15C3R	L15C3S
30 cm	N30C2	L30C2R	L30C2S	L30C3R	L30C3S
1 m	N1M2	L1M2R	L1M2S	L1M3R	L1M3S
3 m	—	L3M2R	L3M2S	L3M3R	L3M3S
5 m	—	L5M2R	L5M2S	L5M3R	L5M3S
Operating temp.	-10 to 80°C				
Remarks	Twisted for ≥ 50 cm	L-6 L-9 for ≥ 6 m		L-7 L-10 for ≥ 6 m	

* For other lead-wire cable lengths, contact us.

KFEL ● Uniaxial, Biaxial, Triaxial

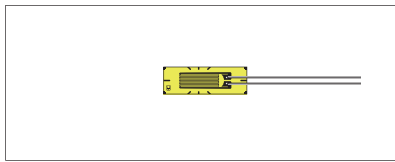

Models	KFEL-5-120-C1
Pattern	Uniaxial
Base	11 × 3.5 mm
Gage (Grid)	5 × 2.1 mm
Resistance	120 Ω
Pieces per Pack	10

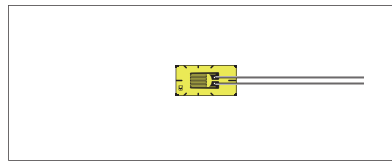

Models	KFEL-2-120-C1
Pattern	Uniaxial
Base	8 × 4 mm
Gage (Grid)	2 × 2.1 mm
Resistance	120 Ω
Pieces per Pack	10

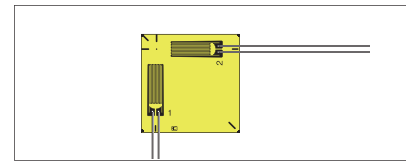

Models	KFEL-5-120-D34
Pattern	Biaxial, 0°/90°
Base	13 × 13 mm
Gage (Grid)	5 × 2.1 mm
Resistance	120 Ω
Pieces per Pack	10

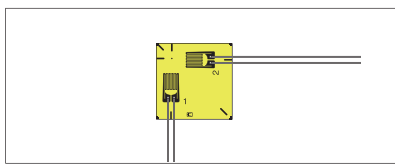

Models	KFEL-2-120-D34
Pattern	Biaxial, 0°/90°
Base	10 × 10 mm
Gage (Grid)	2 × 2.1 mm
Resistance	120 Ω
Pieces per Pack	10

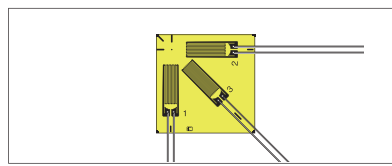

Models	KFEL-5-120-D35
Pattern	Triaxial, 0°/90°/45°
Base	13 × 13 mm
Gage (Grid)	5 × 2.1 mm
Resistance	120 Ω
Pieces per Pack	10

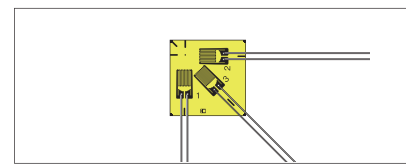

Models	KFEL-2-120-D35
Pattern	Triaxial, 0°/90°/45°
Base	10 × 10 mm
Gage (Grid)	2 × 2.1 mm
Resistance	120 Ω
Pieces per Pack	10

When ordering, specify the model number as follows.

KFEL-□-120-□ Lead-wire Cable Code

e.g.) KFEL-5-120-C1 L1M3R

*Values in □ and lead-wire cable code cannot be arbitrarily combined.

Lead-wire Cable Type and Shape	Oprg. Temp.	Length	Code
Vinyl-coated flat 3-wire cable L-7 (L-10 for 6 m or longer)	-10 to 80°C	1 m	L1M3R:L1M3S
		3 m	L3M3R:L3M3S
		5 m	L5M3R:L5M3S
Vinyl-coated flat 2-wire cable L-6 (L-9 for 6 m or longer)	-10 to 80°C	1 m	L1M2R:L1M2S
		3 m	L3M2R:L3M2S
		5 m	L5M2R:L5M2S
2 polyester-coated copper wires	-10 to 80°C	30 cm	N30C2
		50 cm, 1 m	N50C2
		1 m	N1M2
Silver-covered copper wires	-10 to 80°C	25 mm	

*Gage (Grid): Length × Width

Non-magneto-resistive Gages

KFNB

● Gage Factor	Approx. 2.0
● Applicable Linear Expansion Coefficients ($\times 10^{-6}/^{\circ}\text{C}$)	11, 16, 23
● Self-temperature-compensation Range	0 to 150°C

Applicable Adhesives and Operating Temperature Ranges

PC-600: -196 to 150°C
CC-33A: -196 to 120°C

Non-inductive Foil Strain Gages

RoHS

The gage element is made of a special alloy which provides less magneto-resistant effect; also, the shape is designed to eliminate induction.

Thus, the KFNB series foil strain gages allow the strain to be measured accurately under AC magnetic environments.

Types, lengths and codes of lead-wire cables pre-attached to KFNB gages

Type	Vinyl-coated normal-temperature low-noise 3-wire cable
Length	C9, D20
15 cm	J15C3
30 cm	J30C3
1 m	J1M3
3 m	J3M3
5 m	J5M3
Operating temp.	-10 to 80°C
Remarks	L-13

* For other lead-wire cable lengths, contact us.

KFNB ● Uniaxial, Biaxial

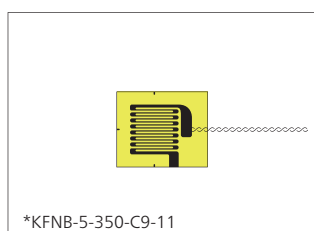

*KFNB-5-350-C9-11

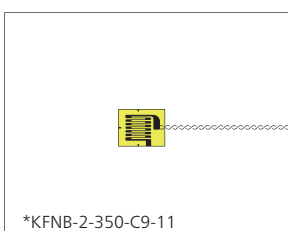

*KFNB-2-350-C9-11

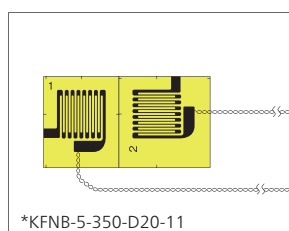

*KFNB-5-350-D20-11

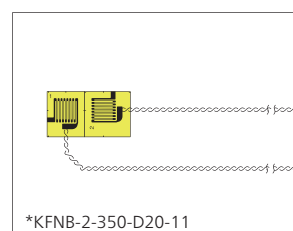

*KFNB-2-350-D20-11

Models	KFNB-5-350-C9-11	KFNB-2-350-C9-11	KFNB-5-350-D20-11	KFNB-2-350-D20-11
	11 16 23	11 16 23	11 16 23	11 16 23
Pattern	Uniaxial	Uniaxial	Biaxial, 0°/90° plane arrangement	Biaxial, 0°/90° plane arrangement
Base	12 × 10 mm	6 × 5 mm	22 × 12 mm	11 × 6 mm
Gage (Grid)	5 × 6.6 mm	2 × 3.5 mm	5 × 6.6 mm	2 × 3.5 mm
Resistance	350 Ω	350 Ω	350 Ω	350 Ω
Pieces per Pack	10	10	5	5

When ordering, specify the model number as follows.

KFNB-□-350-□-□ Lead-wire Cable Code

(e.g.) KFNB-5-350-C9-11 J1M3

*Values in □ and lead-wire cable code cannot be arbitrarily combined.

Lead-wire Cable Type and Shape	Oprg. Temp.	Length	Code
Vinyl-coated normal-temperature low-noise 3-wire cable L-13	-10 to 80°C	1 m	J1M3
		3 m	J3M3
		5 m	J5M3
2 polyester-coated copper wires 10 cm long	-196 to 150°C	10 cm	

*Gage (Grid): Length × Width

Non-magneto-resistive Gages

KFSB

RoHS

● Gage Factor	Approx. 2.0, 2.1
● Applicable Linear Expansion Coefficients ($\times 10^{-6}/^{\circ}\text{C}$)	11, 16, 23
● Self-temperature-compensation Range	10 to 100°C

Applicable Adhesives and Operating Temperature Ranges

CC-33A: -196 to 120°C
EP-340: -55 to 120°C

Shielded Foil Strain Gages

The KFSB series foil strain gages are shielded by copper foil covering the whole body. Thus, if a large current flows to or around the gage bonding site, noise will be prevented from entering the measuring circuit.

Types, lengths and codes of lead-wire cables pre-attached to KFSB gages

Type	Vinyl-coated normal-temperature low-noise 3-wire cable
Length	J1
15 cm	J15C3
30 cm	J30C3
1 m	J1M3
3 m	J3M3
5 m	J5M3
Operating temp.	-10 to 80°C
Remarks	L-13

* For other lead-wire cable lengths, contact us.

KFSB ● Uniaxial

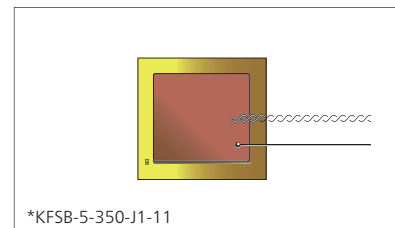
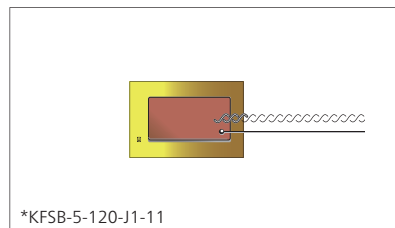

Models	KFSB-5-120-J1-	11 16 23
Pattern	Uniaxial	
Gage Factor	Approx. 2.1	
Base	15 × 10 mm	
Gage (Grid)	5 × 1.4 mm	
Resistance	120 Ω	
Pieces per Pack	10	

Models	KFSB-5-350-J1-	11 16 23
Pattern	Uniaxial	
Gage Factor	Approx. 2.0	
Base	17 × 16 mm	
Gage (Grid)	5 × 6.6 mm	
Resistance	350 Ω	
Pieces per Pack	10	

When ordering, specify the model number as follows.

KFSB-5-□-J1-□ Lead-wire Cable Code

e.g. KFSB-5-120-J1-11 J1M3

*Values in □ and lead-wire cable code cannot be arbitrarily combined.

Lead-wire Cable Type and Shape	Oprg. Temp.	Length	Code
Vinyl-coated normal-temperature low-noise 3-wire cable L-13	-10 to 80°C	1 m	J1M3
		3 m	J3M3
		5 m	J5M3
2 polyester-coated copper wires	-196 to 150°C	25 mm	

*Gage (Grid): Length × Width

Gages for Hydrogen Gas Environment

KFV

RoHS

● Gage Factor Approx. 2.5

Applicable Adhesives and Operating Temperature Ranges
PC-600: -30 to 80°C

■ Foil Strain Gage for Hydrogen Gas Environment

KFV is a foil strain gage that enables stable strain measurement under high-pressure hydrogen gas environments.

To Ensure Safe Usage

Before using KFV strain gages, request the leaflet and read thoroughly the Safety Precautions described there.

KFV ● Uniaxial

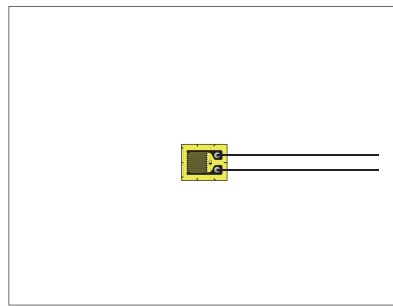

Models	KFV-2-350-C1
Pattern	Uniaxial
Gage Factor	Approx. 2.5
Base	6 × 5 mm
Gage (Grid)	2 × 3.2 mm
Resistance	350 Ω
Pieces per Pack	2

When ordering, specify the model number as follows.

KFV-2-350-C1

Lead-wire Cable Type and Shape	Oprg. Temp.	Length
2 polyester-coated copper wires 	-30 to 80°C	15 mm

*Gage (Grid): Length × Width

Bending Strain Measuring Gages

KFF

RoHS

● Gage Factor	Approx. 2.1
● Applicable Linear Expansion Coefficients ($\times 10^{-6}/^{\circ}\text{C}$)	11, 16, 23
● Self-temperature-compensation Range	20 to 60°C

Applicable Adhesives and Operating Temperature Ranges

CC-33A: -50 to 80°C
EP-340: -50 to 80°C

■ Foil Strain Gages for Bending Strain Measurement

If measuring stress in box structures such as bridge girders, or in high-pressure vessels that do not allow gages to be bonded directly to the inside of the measuring object, the KFF series gages can be bonded to the outside surface to obtain strain on the inside.

KFF ● Uniaxial

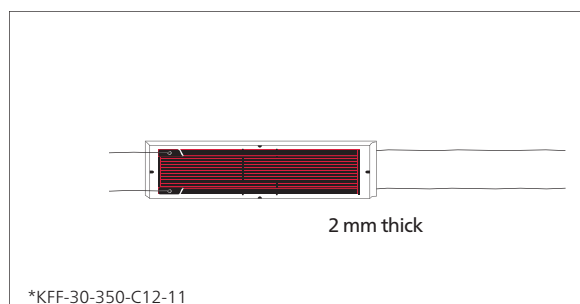
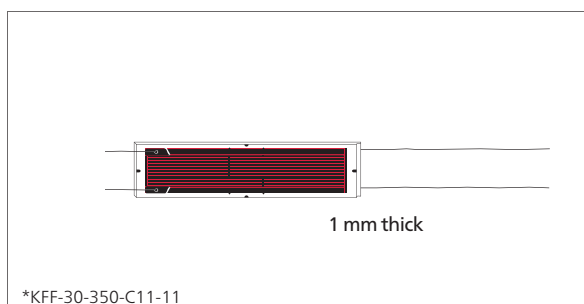

Models	KFF-30-350-C11-	11 16 23
Pattern	Uniaxial 2-element	
Base	30 × 7 × 1 mm	
Resistance	350 Ω	
Pieces per Pack	5	

Models	KFF-30-350-C12-	11 16 23
Pattern	Uniaxial 2-element	
Base	30 × 7 × 2 mm	
Resistance	350 Ω	
Pieces per Pack	5	

When ordering, specify the model number as follows.

KFF-30-350-□-□

ⓔ.g. KFF-30-350-C11-11

*Values in □ cannot be arbitrarily combined.

Lead-wire Cable Type and Shape	Oprg. Temp.	Length
Silver-covered copper wires	-50 to 80°C	25 mm

Gages with a Protector

KCH

RoHS

● Gage Factor Approx. 2.1

Applicable Adhesives and
Operating Temperature Ranges

EP-340: -40 to 100°C
CC-33A: -40 to 100°C



■ Foil Strain Gages with a Protector

The unique design simplifies gage bonding, wiring and moisture-proofing work in the field. In addition, the metal case protects the strain gage and significantly improves reliability compared with conventional gages.

Using stud bolts and adhesive allows the gages to be mounted to the bottom or side plate of a tank for strain measurement, to a hopper or tank for weight measurement, to the shaft of a truck for tare weight measurement or any other similar applications where the gages need to be protected against moisture, water or small stones.

KCH ● Uniaxial, Biaxial, Triaxial

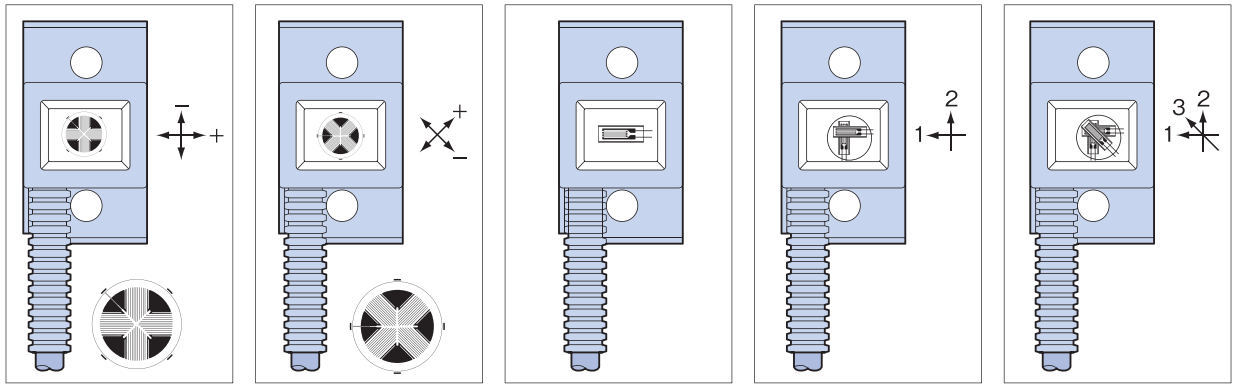

Models	KCH-5A-B KCH-5A-BJ	KCH-5A-S KCH-5A-SJ	KCH-5A-1	KCH-5A-2	KCH-5A-3
Pattern	Full bridge	Full bridge (For shearing strain)	Uniaxial	Biaxial, 0°/90° stacked rosette	Triaxial, 0°/45°/90° stacked rosette
Gage (Grid)	2 mm	2 mm	5 mm	5 mm	5 mm
Resistance	350 Ω	350 Ω	350 Ω	350 Ω	350 Ω
System	Full bridge	Full bridge	3-wire	3-wire	2-wire
Cable	KCH-5A-B and S come with special flexible vinyl-shielded 4-conductor (0.3 mm ²) cable, 6.3 mm diameter by 10 m long, bared at the tip. KCH-5A-BJ and SJ come with special flexible vinyl-shielded 4-conductor (0.3 mm ²) cable, 2 m long (cable cover 1.75 m long) by 6.3 mm diameter (10.2 mm including cable cover) and terminated with waterproof connector jack (R04-P6-M6.8). Relay cables (TN-29 to 33) are optional accessories.		Special flexible vinyl-shielded 4-conductor (0.3 mm ²) cable, 6.3 mm diameter by 10 m long, bared at the tip.	Special flexible vinyl-shielded 6-conductor (0.3 mm ²) cable, 6.8 mm diameter by 10 m long, bared at the tip.	

When ordering,
specify the model number as follows.

KCH-5A-□

Ⓔ e.g. KCH-5A-B

● Relay Cables (for KCH-5A-BJ/SJ) (Optional Accessories)

Model	TN-29	TN-30	TN-31	TN-32	TN-33
Cable length	2 m	3 m	7 m	10 m	12 m
Cable cover length	1.5 m	2.5 m	6.5 m	9.5 m	11.5 m
Remarks	With waterproof connector jack (R04-J6-F6.8) Bared at the tip				

Embedded Gages

KMP

RoHS

● Gage Factor Approx. 2.0

Operating Temperature Ranges
20 to 150°C

Compensated Temperature Ranges
20 to 120°C



■ Embedded Gage

Embedded in resin, the KMP gage measures cure-shrinkage and internal strain. The compact design enables embedment in shaped resins and is suitable for internal stress measurement of products made by combining epoxy resin and metal.

KMP

Developed by Mitsubishi Electric Corp.
Commercialized by Kyowa Electronic Instruments Co., Ltd.

Resistance	120 Ω
Gage Factor	Approx. 2.0
Length of Sensing Element	1 mm
Apparent Young's Modulus	Approx. 70 GPa
Built-in Thermocouples	K (ϕ 0.1)

When ordering,
specify the model number as follows.

KMP-8-H3-L100

Crack Gages

Bonded to the cracked part of a structure or material (or a part of such material where a crack is predicted to develop), the KV series gages measure the developing length and velocity of the crack.

Different from usual strain gages, the grids of the KV series gages are cut along with crack development, resulting in resistance change.

Applicable Adhesives

CC-33A
CC-36
PC-600

- Progress and propagation velocity of the crack are electrically obtained.
- Applicable to both flat and curved surfaces.
- Resistance change vs crack length is virtually linear.
- Dedicated adapter enables use of a conventional strain amplifier.
- Extremely simple and convenient compared with the conventional optical method.
- 2 trigger wires each in front of and behind the grid (KV-5C) can be used for automation of measurement.

KV Uniaxial

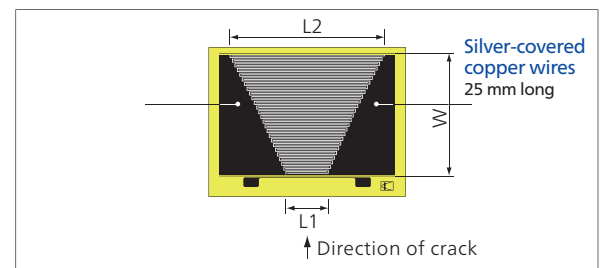
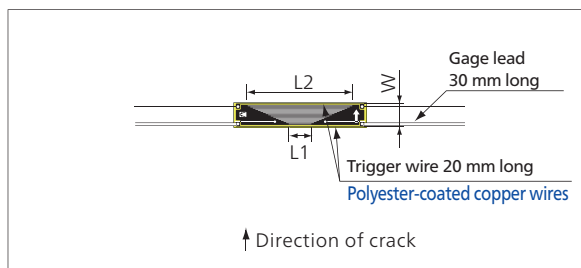

Models	KV-5C
Pattern	Uniaxial
Base	30 × 5 mm
Gage (Grid)	L1= 5.4 mm L2= 25.2 mm W= 4.6 mm Pitch= 0.1 mm
Number of Grids	46
Resistance	Approx. 1.0 Ω
Pieces per Pack	5

Models	KV-25B
Pattern	Uniaxial
Base	42 × 32 mm
Gage (Grid)	L1= 9 mm L2= 33.6 mm W= 25.2 mm Pitch= 1 mm
Number of Grids	26
Resistance	Approx. 1.0 Ω
Pieces per Pack	5

Adapter KVA-1A (Optional Accessory)



Dimensions: 35×20×15mm

Connection Diagram

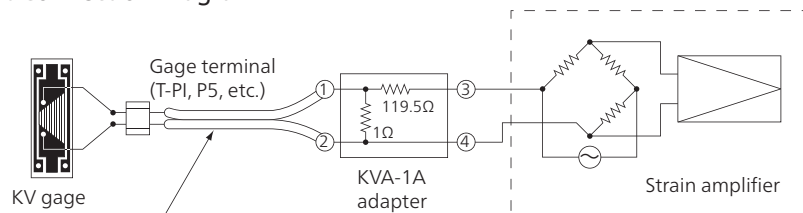

Note: Use lead wires with a low resistance to connect to the adapter (0.1Ω or less).

When ordering, specify the model number as follows.

KV-5C
KV-25B

*Gage (Grid): Length × Width

**Concentrations of the 10 restricted substances designated in ANNEXII of RoHS Directive are less than the maximum allowable (Excluding exceptions for applying usage prohibition measures).

Encapsulated Gages

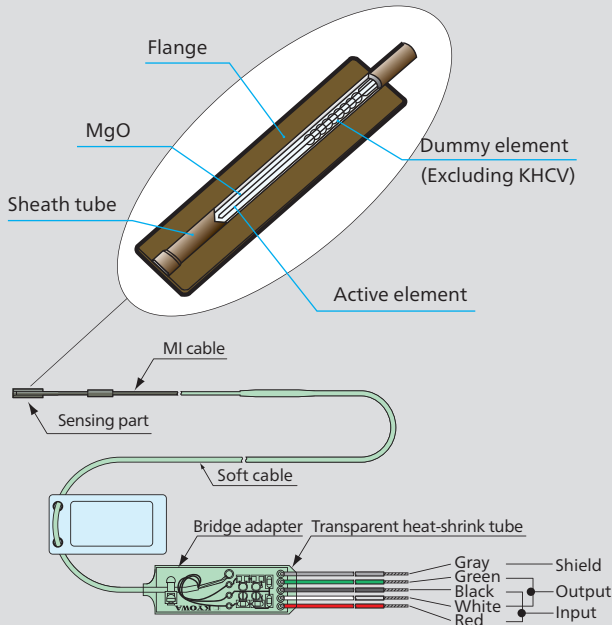

* The above picture is KHCR with a bridge adapter.

Encapsulated Gages

Encapsulated Gages are welded-type strain gages with a completely airtight structure. The product consists of a sensing part and a cable for signal output. The sensing part is comprised of a flange and an environmentally resistant metallic tube with encapsulated gage and insulator. The sensing part can be fixed to the measurement material by using a compact spot welder GW-3C. Using the high-temperature model, strain measurement can be conducted even in harsh environments involving high temperature, high pressure, and high humidity, such as nuclear-power generation, automobiles, and planes. The specifications are for reference purpose only. Actual values may vary depending on operating conditions including temperatures.

- Gages and lead-wire cables (MI cables) are covered and integrated with metals (such as NCF 600) with excellent environmental properties including heat or corrosion resistance, and can be used in high temperature and high-pressure environments, seawater, and pure water.
- Provides high-precision measurement with minimal thermally-induced apparent strain (KHCV, KHCR, KHCS, KHCM, KHC).
- Detailed test data sheet allows strain measurement to be conducted with high precision.

Types and typical applications

Type	Normal Temp.		High Temp.				
Model	KCW	KHC	KHCM	KHCS	KHCR	KHCV	KHCX
Measuring strain	Static/Dynamic			Dynamic		Static/Dynamic	
Max. oprg. temp. ^{*1}	100°C	500/550°C	650°C	750°C	750°C	800°C	950°C
Temp. comp. ^{*2}	Yes			No		Yes	

*1 Max. oprg. temp.: Max. operating temperature

*2 Temp. comp.: Temperature compensation

Scope of application	0°C	10°C	200°C	300°C	400°C	500°C	600°C	700°C	800°C	900°C	1000°C
Energy	Boiler water pump in thermal power stations			Cooling pipes (pure water) in nuclear power stations Gas turbine combustors			Heat exchangers in thermal power stations Nuclear fuel rods	Around nuclear power reactors Cooling waterpipe (sodium) in nuclear power reactors Boiler steam turbines Fast breeder reactors			Dynamic and stationary blades in high-temperature gas turbines High temperature gas furnaces
Plant Large structure	Various plumbing of large plants Ship structures (in seawater) Underwater tests of steel reinforced concrete structures				Around high-temperature furnaces for steel manufacturing Fireproof tests for steel reinforced concrete structure					Petrochemical reactors Heat treatment furnaces Incinerators	
Automobile Aviation Shipping	Automobile intake blowers			Automobile cylinder heads Automobile pistons			Automobile exhaust manifolds Automobile exhaust valves	Automobile exhaust turbines		Ship turbines Aircraft jet engine turbines	

Custom-designed Gages

Various custom-designed gage patterns and lengths are available to meet the needs of your measurement. For details, please contact us. Below are some illustrated examples of custom-designed strain gages.

5-element pattern for shearing strain



Enlarged view

Small uniaxial pattern with lead wires from both ends



Enlarged view

Uniaxial 2-element half-bridge pattern

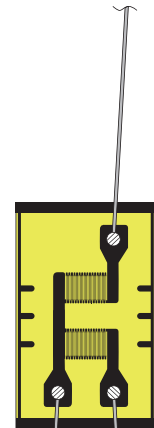

Enlarged view

Uniaxial 2-element pattern

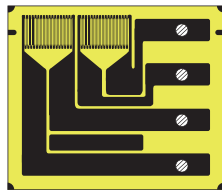

Enlarged view

Biaxial orthogonal half-bridge pattern

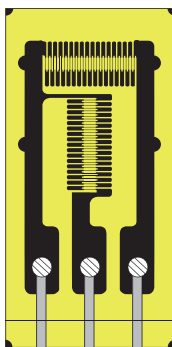

Enlarged view

Small uniaxial pattern with lead wires from both ends



Enlarged view

Ultra-small biaxial 0/90° crossed pattern

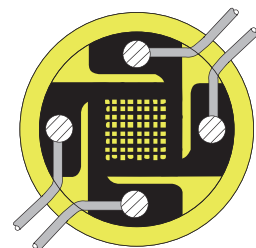

Enlarged view

Multi-element pattern

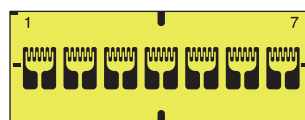

Enlarged view

Strain Gages for Transducers

Being excellent in nonlinearity & repeatability, strain gages can be used not only to test strain, but to make transducers as well.

We use our own strain gages to produce our strain gage transducers, so naturally the transducers are of high reliability.

We provide various strain gages for our customers to make their own transducers to test load, force, pressure, torque, etc.

The following patterns are some examples. For details, please contact us.

Diaphragm pattern

Applicable transducers

Pressure transducers

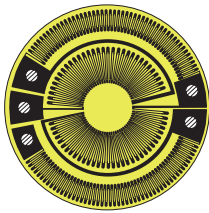

Biaxial shearing pattern

Applicable transducers

Torque transducers

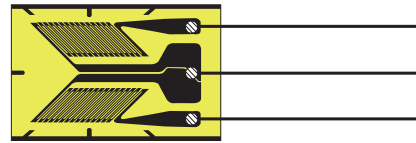

Full-bridge pattern

Applicable transducers

Load cells and displacement transducers

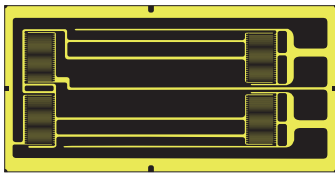

Uniaxial 2-element half-bridge pattern

Applicable transducers

Load cells and pressure transducers



Full-bridge pattern

Applicable transducers

Load cells

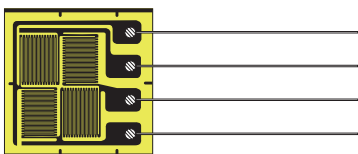

Uniaxial 2-element pattern

Applicable transducers

Load cells and displacement transducers

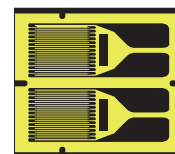

Uniaxial

Applicable transducers

Load cells, pressure transducers, displacement transducers, and acceleration transducers

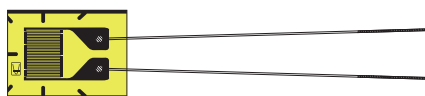

Biaxial half-bridge pattern

Applicable transducers

Load cells and pressure transducers

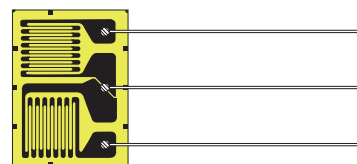

You can count on Kyowa.

Feel free to contact us,
if there is something you would like to know or
do not understand about Kyowa products.

Sales Network



Other Countries or Regions

Please visit below URL.
Website: www.kyowa-ei.com

Americas Region

KYOWA AMERICAS Inc.
TEL: +1-248-348-0348
E-mail: sales@kyowa-americas.com
Website: www.kyowa-ei.us

China

KYOWA ELECTRONIC (SHANGHAI) TRADING CO., LTD.
TEL: +86-21-64477770
E-mail: support-cn@d1.kyowa-ei.co.jp
Website: www.kyowa-ei.cn

Thailand

KYOWA DENGYO (THAILAND) CO., LTD.
TEL: +66-2-117-3760
E-mail: sales-thailand@kyowa-ei.co.th
Website: www.kyowa-ei.th

India

KYOWA ELECTRONIC INSTRUMENTS CO.,LTD. (India Branch)
TEL: +91-124-427-7227
Website: www.kyowa-ei.com

KYOWA ELECTRONIC INSTRUMENTS CO., LTD.

Overseas Sales Department:
3-5-1, Chofugaoka, Chofu, Tokyo 182-8520 Japan
TEL: +81-42-489-7220 FAX: +81-42-488-1122
E-mail: kyowaoverseas.hp@d1.kyowa-ei.co.jp
Website: www.kyowa-ei.com

Cat.No. 101I E1-1



Safety Precautions

- Be sure to observe the safety precautions given in the instruction manual, in order to ensure correct and safe operation.
- Do not use in locations subject to significant water, dampness, steam, dust, or flammable gases.
Doing so may lead to fire, electrical shock, or malfunction.

- Specifications and designs are subject to change without notice.
- Please contact us if using the detailed products for special applications.
- Detailed company and product names are the trademarks or registered trademarks of their respective owners.
- The warranty details can be found on the "Product Warranty" attached to the product and on the following website.
www.kyowa-ei.com/eng/company/quality/warranty.html
- Unauthorized use or reproduction of contents of this catalog are prohibited.



JQA-0821
JQA-EM4824

Printed in Japan October 2020



Instrumentation Devices Srl

Via Acquanera 29 - 22100 COMO (Italy)
ph +39 031 525 391- fax +39 031 507 984
info@instrumentation.it - www.instrumentation.it