



# KMT - Kraus Messtechnik GmbH



Gewerbering 9, D-83624 Otterfing, Germany, ☎ 08024-48737, Fax. 08024-5532  
Home Page <http://www.kmt-gmbh.com>, Email: info@kmt-gmbh.com

## TEL1-PCM

### Operating Instructions

### Digital Telemetry System for Strain Gage Applications on Rotating Shafts

*"Gain and Auto Zero setting direct from Receiver Side!"*

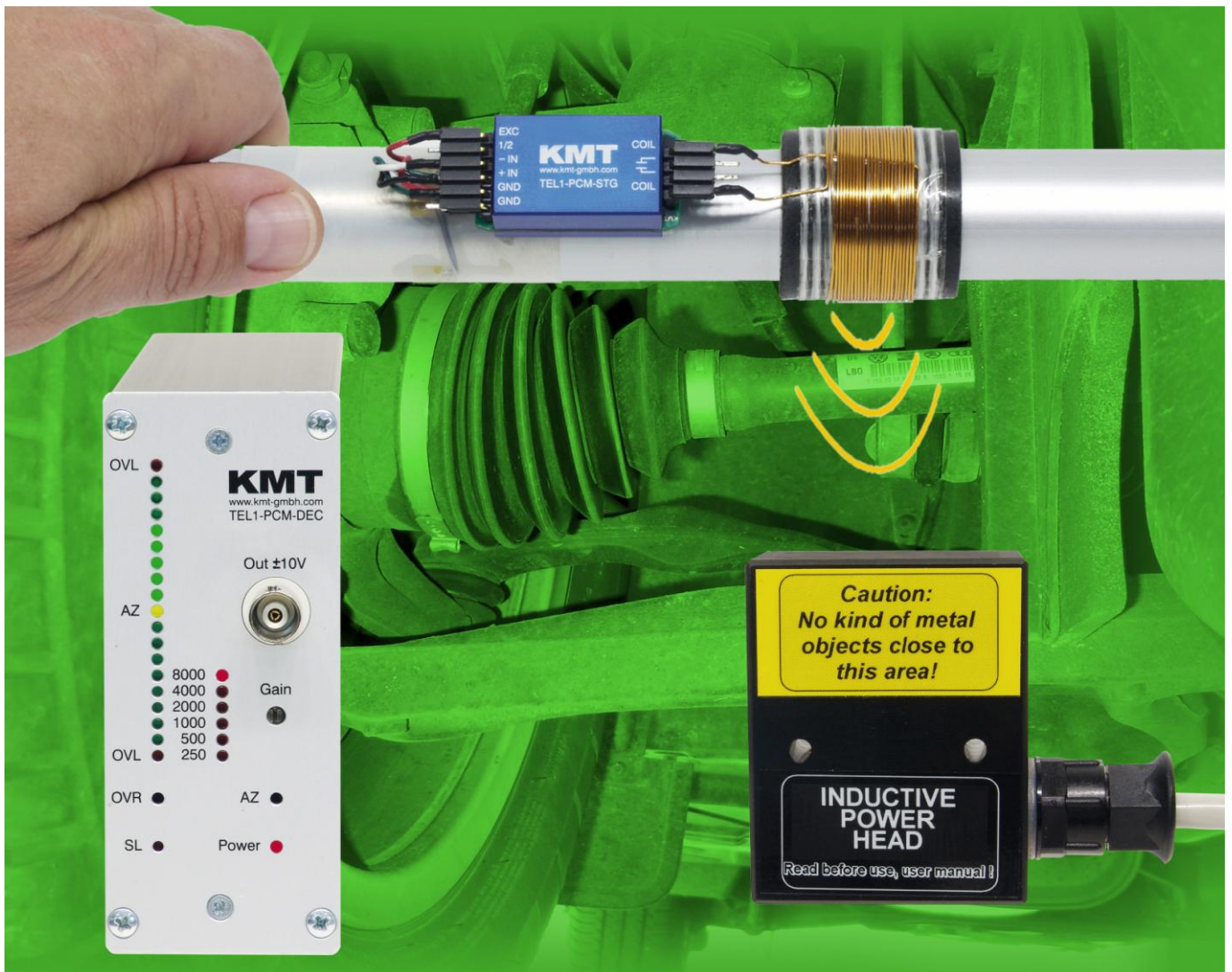

## General Description

The TEL1-PCM single-channel telemetry system offers the easiest handling for the wireless transmission of strain gage signals from rotating shafts. The very small encoder 35 x 18 x 12 mm with a weight of 13g. The transmitter (encoder) part is simply mounted on the rotating shaft with a special fiber reinforced tape.

Powering of the transmission part and the digital data transfer between transmitter and receiver is realized inductively.

## Functional Description

The TEL1-PCM transmitter provides a pulse code modulated signal (PCM) to an induction winding around the *shaft (max. diameter 500mm, other on request!)*. The magnetic field of this winding enables the inductive transmission of the signal to the pickup coil. From there the signal is transferred by cable (5m) to the receiver. The maximum distance between the transmitter coil and the pickup is 25mm with standard head, optional 35mm

The receiver unit offers a BNC connector at the front panel with analog outputs  $\pm 10$  V and a optional a digital output for PCM-LAN IP-Interface. An LED bar indicator shows the actual level and a successful Auto Zero calibration. Overload is indicated by the last LED's in pos. or neg. direction of the bar graph. These OVL-LED's operate in peak-hold mode and are reset by pressing the overload switch.

Strain gage sensors (>350 Ohm) in full- and half- bridge configuration can be directly connected to the transmitter. The excitation is fixed to 4 Volt DC and the gain is set by the gain switch on the receiver side. An auto-zero (AZ) adjustment is executed by pressing the AZ button on the front side of the receiver. The successful AZ operation is indicated by a yellow LED in the middle of the LED bar indicator. When the AZ completes the LED continuously illuminates. The AZ setting is stored in a Flash-RAM and thus is not lost during power-off. Use only shielded sensor cable.

## TEL1-PCM Set Contains:

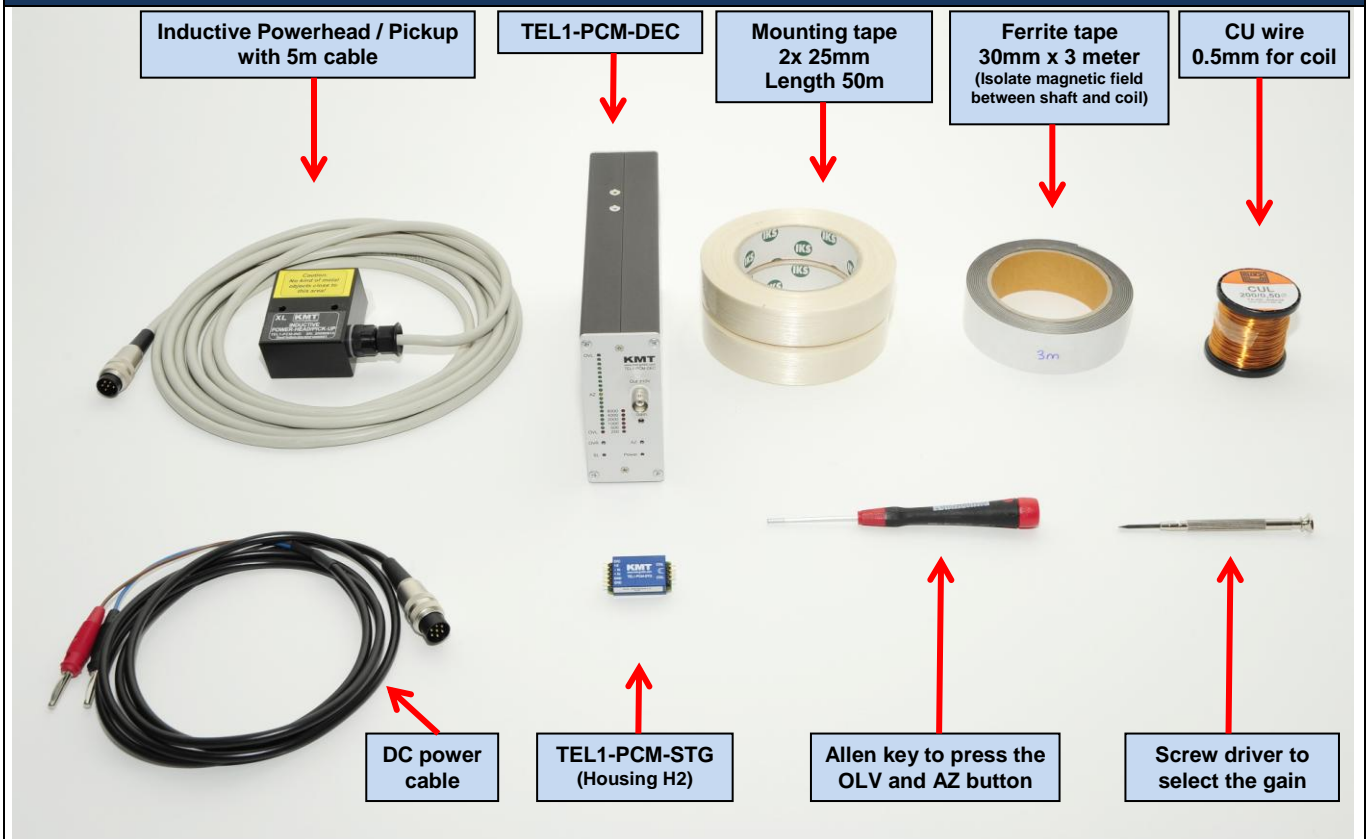

# Technical Data Transmitting Part:



New version 4.0 without external CAL pins

With **built-in** 220nF capacitor for shaft up to 400mm recommend!  
Standard version!



Without built-in capacitor. Only with **external** capacitor! E. g. 100nF for larger shaft >400mm! Specify at order!



with female K type thermocouple connector

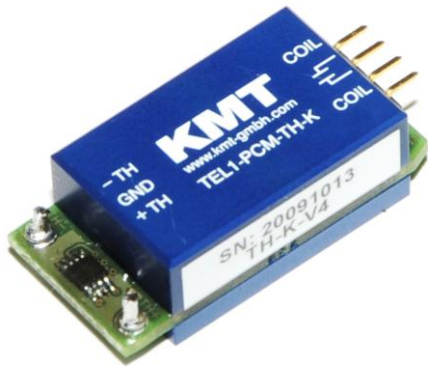

with solder pins for thermocouple

Analog signal bandwidth: 0 - 10 Hz (-3 dB)  
Accuracy: +/-0.5 % (without sensor)  
Operating temperature: - 10 to + 80 °C  
Dimensions: 35 x 18 x 12mm (without th-connector)  
Weight: each module 13 grams (with epoxy resin)  
Static acceleration: up to 3000g  
(housing not filled with epoxy resin)  
Static acceleration: up to 10000g  
(housing filled with epoxy resin and without solder pins and external capacitor!)Powering: Inductive  
(optional Battery, see TEL1-PCM-BATT!)Housing: splash-water resistant IP65  
(except the connector pins)

## TEL1-PCM-STG

Strain gage: Full and 1/2 bridge >350 Ohm,  
Excitation: 4 VDC (fixed)  
Gain: 250; 500; 1000; 2000; 4000; 8000 (selectable from receiver side)

Gain	Resolution	Autozero range
250	12 bit	100%
500	12 bit	200%
1000	12 bit	400%
2000	12 bit	400%
4000	12 bit	400%
8000	11 bit	400%

AZ: Auto Zero calibration (selectable from receiver side)  
Analog signal bandwidth: 0 - 1200 Hz (-3 dB)  
Operating temperature: - 10 to + 80 °C  
Scanning rate 7.5kHz  
Dimensions: 35 x 18 x 12mm (without connectors)  
Weight: each module 13 grams (with epoxy resin)  
**Static acceleration: up to 3000g**  
(housing not filled with epoxy resin)  
**Static acceleration: up to 10000g**  
(housing filled with epoxy resin and without solder pins and external capacitor!)Powering: Inductive (optional Battery, see TEL1-PCM-BATT!)Housing: splash-water resistant IP65 (except the connector pins)

## TEL1-PCM-TH-K - Select Gain 250!

At Gain 500 multiply the values x2, Gain 1000 with x4  
Max. Voltage output at receiver is +10V!

°C	Output at receiver (DEC)		
	Normal (V)	Min. (V)	Max. (V)
0	-0,005	-0,050	0,050
50	0,508	0,450	0,550
100	1,012	0,950	1,050
150	1,505	1,450	1,550
200	2,000	1,950	2,050
250	2,505	2,450	2,550
300	3,010	2,950	3,050
350	3,511	3,450	3,550
400	4,014	3,950	4,050
450	4,511	4,450	4,550
500	5,011	4,950	5,050
550	5,511	5,450	5,550
600	6,010	5,950	6,050
650	6,507	6,450	6,550
700	7,007	6,950	7,050
750	7,507	7,450	7,550
800	8,007	7,950	8,050
850	8,505	8,450	8,550
900	9,003	8,950	9,050
950	9,502	9,450	9,550
1000	9,999	9,950	10,050



## Technical Data Receiving Part



Front

Rear

### TEL1-PCM-DEC

#### Front side:

Analogue output: +/-10V via BNC (**Optional 4-20mA output**)  
 Digital output for PCM-LAN-IP-Interface OPTION  
 Gain setting : via screw switch  
 Auto Zero setting: via micro switch  
 Overload LED's (Red ON) reset: via micro switch  
 Green LED's: Bargraph +/-  
 Autozero LED:  
     Yellow ON- successful AZ  
     Yellow OFF- not successful AZ  
     *if flashing, call support of KMT, error in EPROM*  
 Green LED's: Bargraph +/-  
 SL LED: Red ON = if error of data transmitting  
 SL LED: Red Flashing = distance to far  
 Power ON LED: Red ON = if power switch on

#### Rear side:

Output to Powerhead: via 6pol. Tuchel  
 Fuse LED: Flashing if fuse is defect  
 Powering: 10-30V DC (**min. 24Watt**), Input via 7pol. Tuchel  
 Switch: ON/OFF  
 Operating temperature: - 10 to +70 °C  
 Dimensions: 200 x 105 x 44 (without connectors!)  
 Weight 950 grams  
 Static acceleration: up to 200g  
 System accuracy\*: +/- 0.2 %  
*<\*measure with gain 1000, 350ohm (0.1%) full bridge - test bridge!>*



### TEL1-PCM-Powerhead/Pickup (standard version)

Function: Inductive powering of the TEL1-PCM-STG unit and receiving PCM magnetic field in PCM modulated code  
 Distance between the transmitter coil and the pickup is 25mm  
**(25mm at diameter <300mm with 5m cable, 15mm with 10m cable)**  
 (Optional 35mm at diameter <300mm - see table)  
 Output to TEL1-PCM-Decoder: Via 6pol. Tuchel Plug incl. 5m cable  
 Operating temperature: - 10 to +80 °C  
 Dimensions: 53x66x30mm (without cable)  
 Weight: 200 grams (without cable!)  
 Housing: splash-water resistant IP65 (except connector).  
 Cable length standard 5m! 10m optional!

## Transmitting Part:

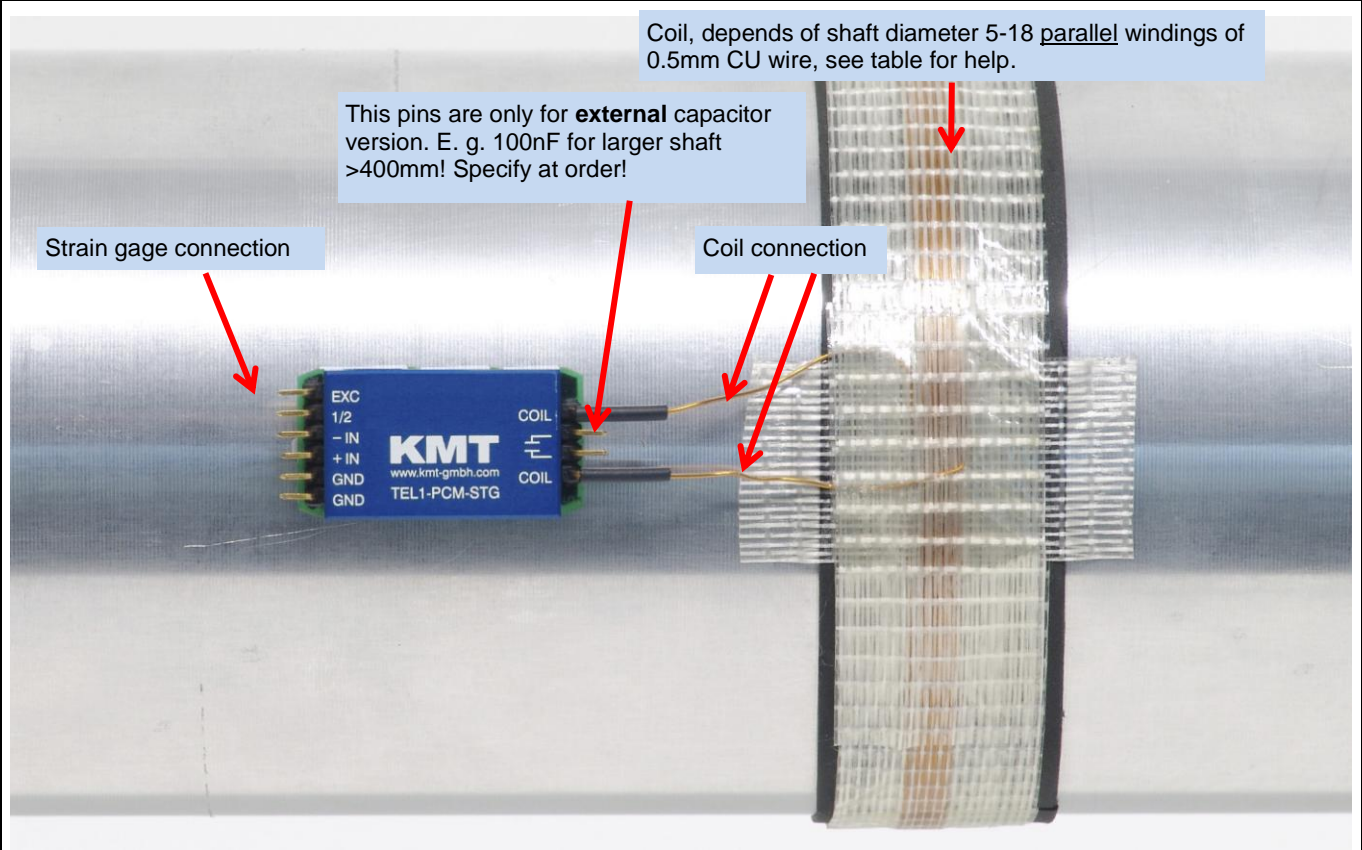

## Receiving Part:

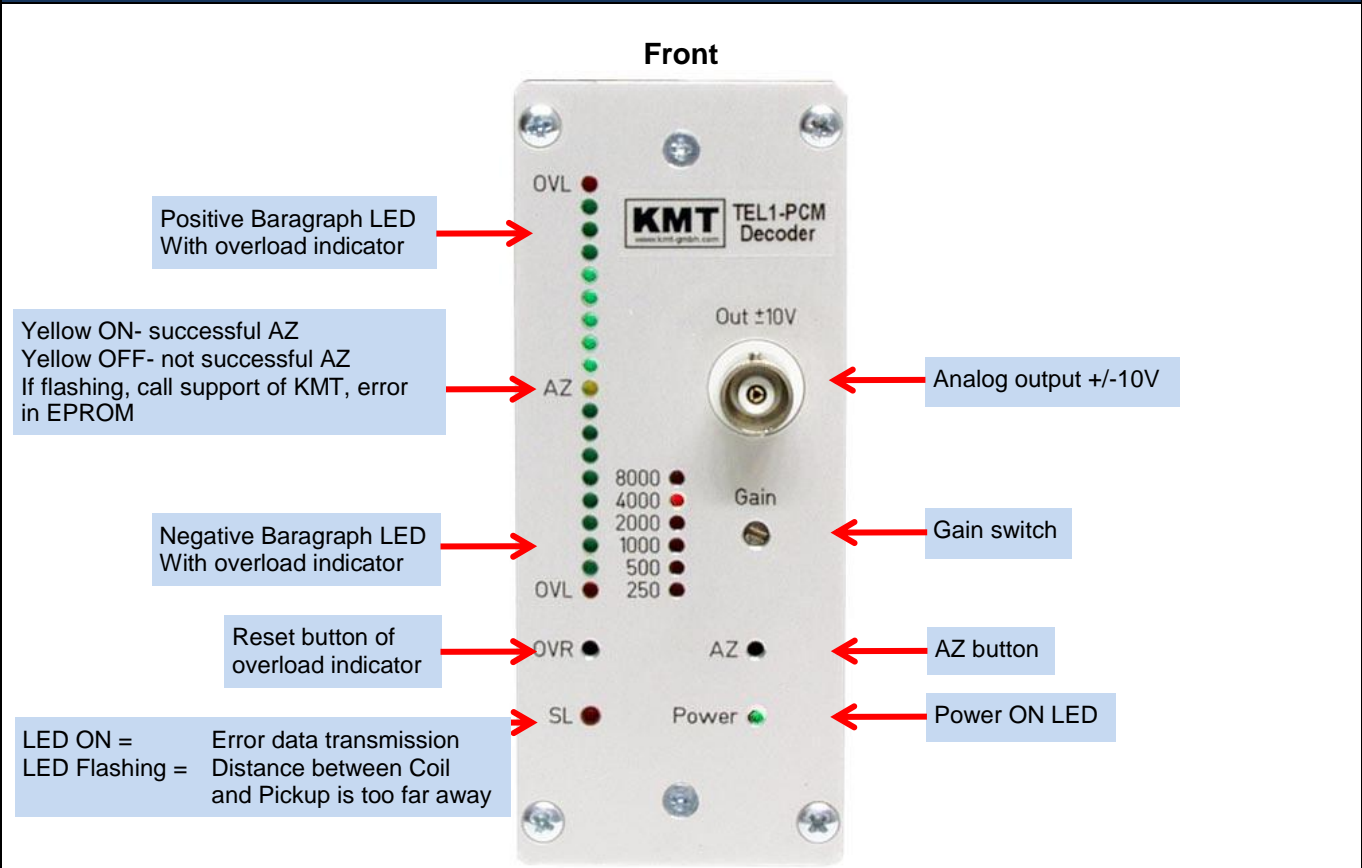

## Rear

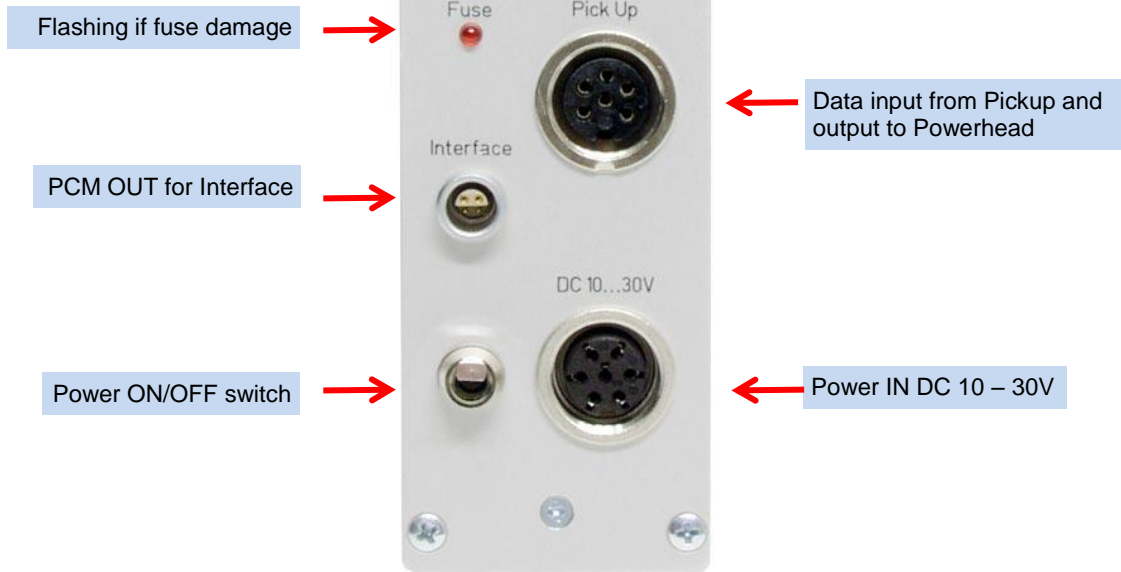

### Powerhead / Pickup

Standard version for distance of 5-25mm  
(Optional 5-35mm)

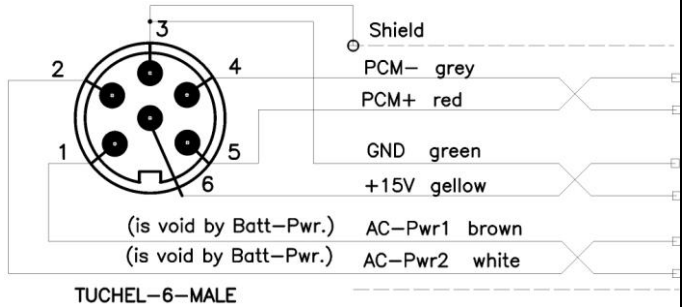

### DC-Power cable

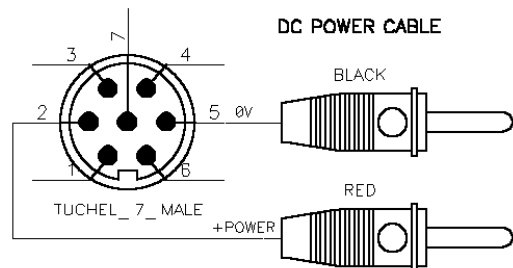



# Dimensions Encoder - TEL1-PCM-STG

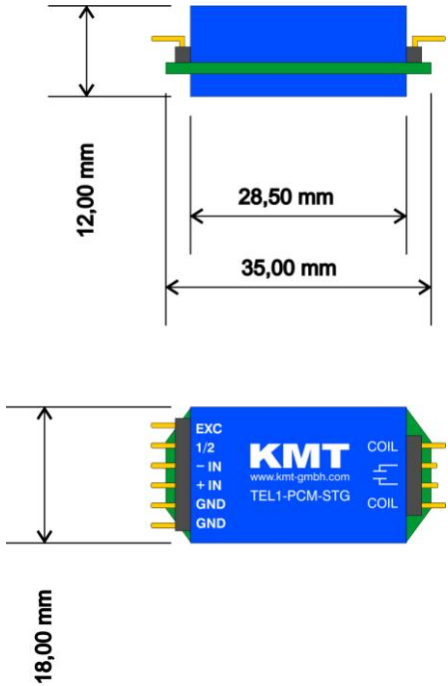

Version 4.0

Draw about 1:1

Weight 13gram



## Shaft Installation

2 layers (each separately) of the special ferrite tape around the shaft



Fix with 2 layers of mounting tape around the shaft



Coil, depends of shaft diameter 5-18 parallel windings of 0.5mm CU wire, see table for help.

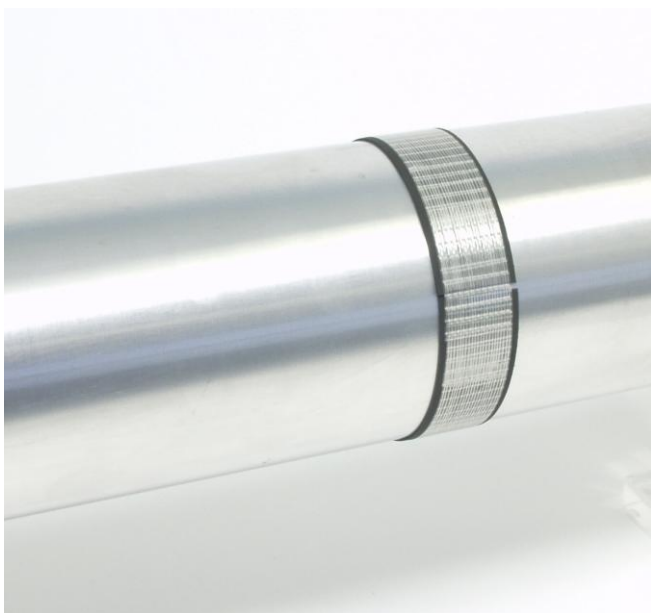

Solder the wires of the coil on the input pins of TEL1-PCM-STG "COIL". The pins for capacitor are used only for larger diameter >400mm!

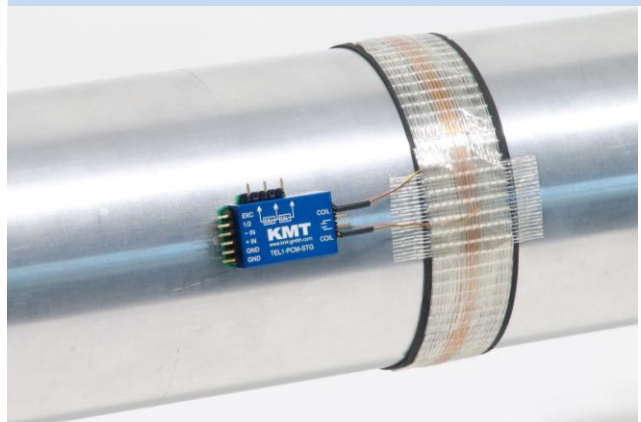
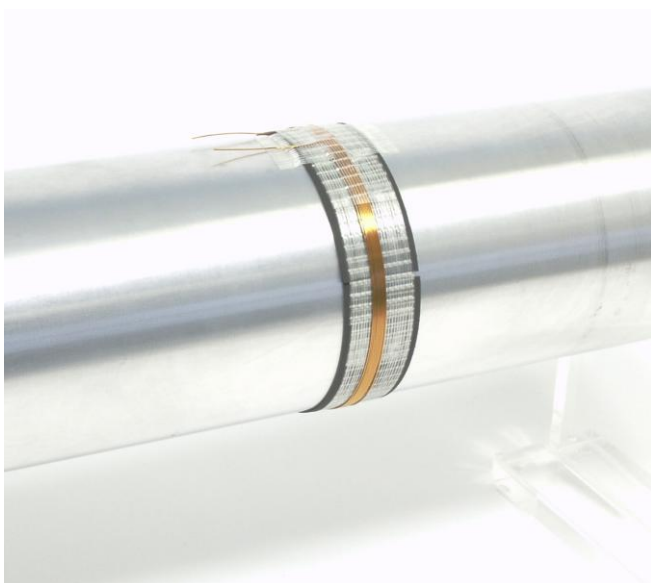

10 layers of the special mounting tape around the shaft. We recommend additionally use of a **hose clamps** for final fixing of the transmitter unit!!

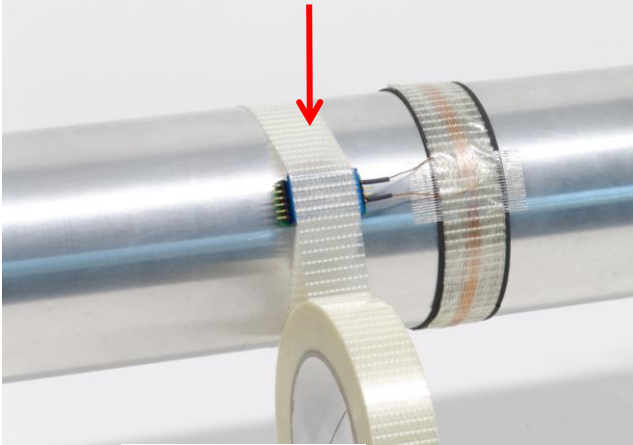

hose clamps

Fix with 3 layers of mounting tape around the coil and cables

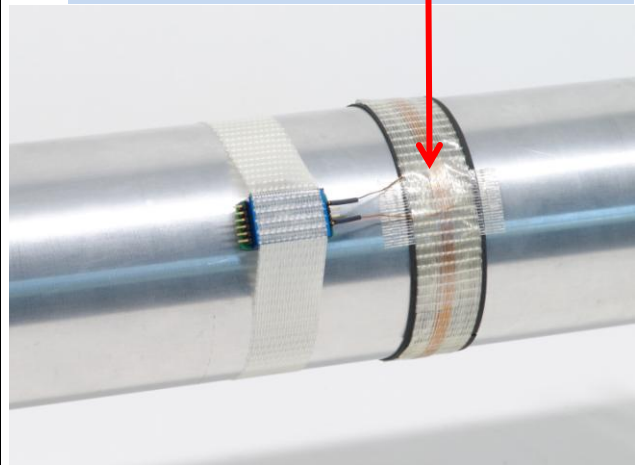

### Caution:

Fix TEL1-PCM module with at least 10 layers of the special mounting tape (**only for up to 1000g!**) around the shaft. Depending on the shafts RPM and diameter particular attention needs to be paid to the safe mounting of the components.

**The manufacturer doesn't accept liability for damages, which results from insufficient attachment of the individual components.**

The tape is only for test purposes, in order to test the electrical function of the units in the idle state of the shaft.

During the rotation test appropriate safety precautions should be taken.

The entire installation may be used only by authorized persons. By using tape for the attachment, it has to be used in the direction of rotation of the shaft and the end has to be secured. Only non-elastic tapes (**Fiberglass Tape**) with high tensile strength (100kg/25mm) should be used for pre-fixing. Additionally, use hose clamps for final fixing!! The individual components are to be distributed in such a way on the shaft that imbalances are avoided.

## Finding the Correct Number of Windings

The number of windings depends on several factors. The most important influential factors are the diameter, the material of the shaft and the environment around the shaft. The table standing below will help you to find the right number windings for steel shafts. The table below is a help to estimate the number of windings fast. To optimize your results you can try one winding more or less.

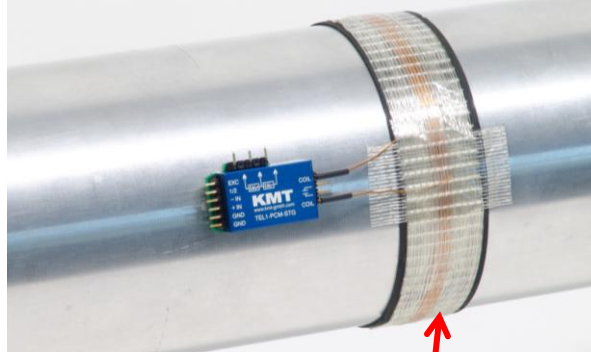

Coil, depends of shaft diameter, 5-18 parallel windings of 0.5mm CU wire

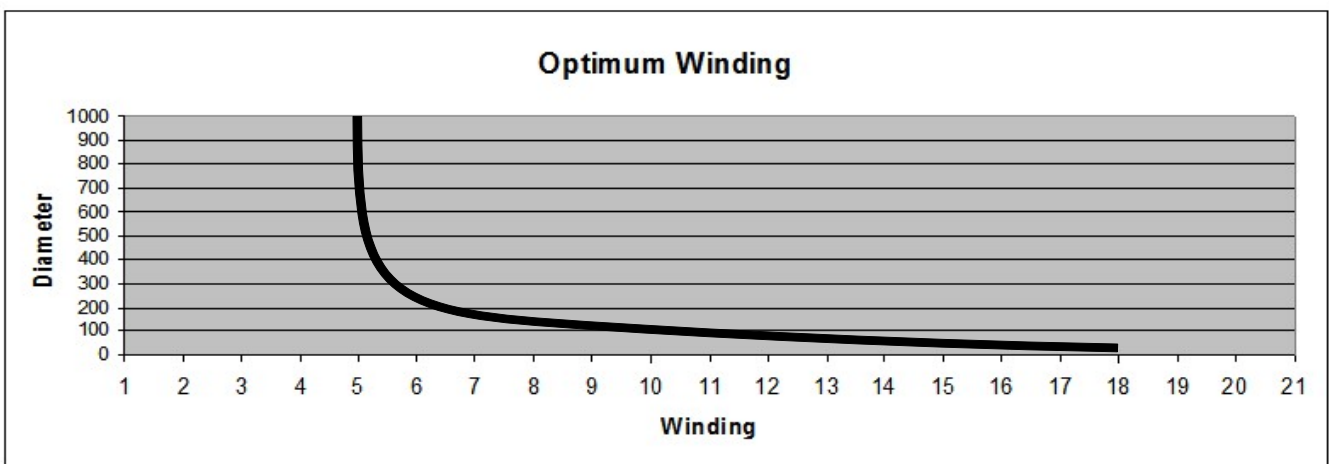

Diameter (mm)	Windings +/-1	max. distance with XL (35mm) Powerhead	Ferrite tape no. of layers	recommend capacitor (Type MKT or MKS 250V)
1000	5	12mm	2	<b>without</b> built-in 220nF, only with external 68nF (specify at order)
500	5	22mm	2	<b>without</b> built-in 220nF, only with external 100nF (specify at order)
500	3	8mm	2	with built-in 220nF (is standard in housing) Not recommend for large diameters!!!!
300	5	27mm	2	with built-in 220nF (is standard in housing)
210	6	28mm	2	with built-in 220nF (is standard in housing)
160	7	28mm	2	with built-in 220nF (is standard in housing)
130	8	35mm	2	with built-in 220nF (is standard in housing)
90	11	35mm	2	with built-in 220nF (is standard in housing)
60	13	35mm	2	with built-in 220nF (is standard in housing)
30	14	35mm	2	with built-in 220nF (is standard in housing)
20	18	35mm	2	with built-in 220nF (is standard in housing)



With **built-in** 220nF capacitor for shaft up to 400mm recommend!  
Standard version!

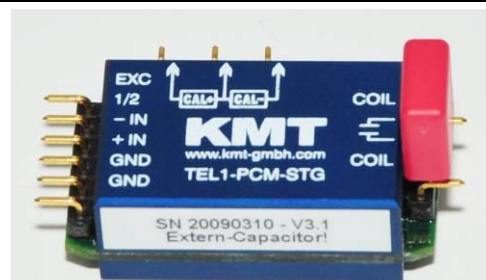

Without built-in capacitor. Only with **external** capacitor! E. g. 100nF for larger shaft >400mm! Specify at order!

# Following must be considered at the mounting of the inductive power head at TEL1-PCM

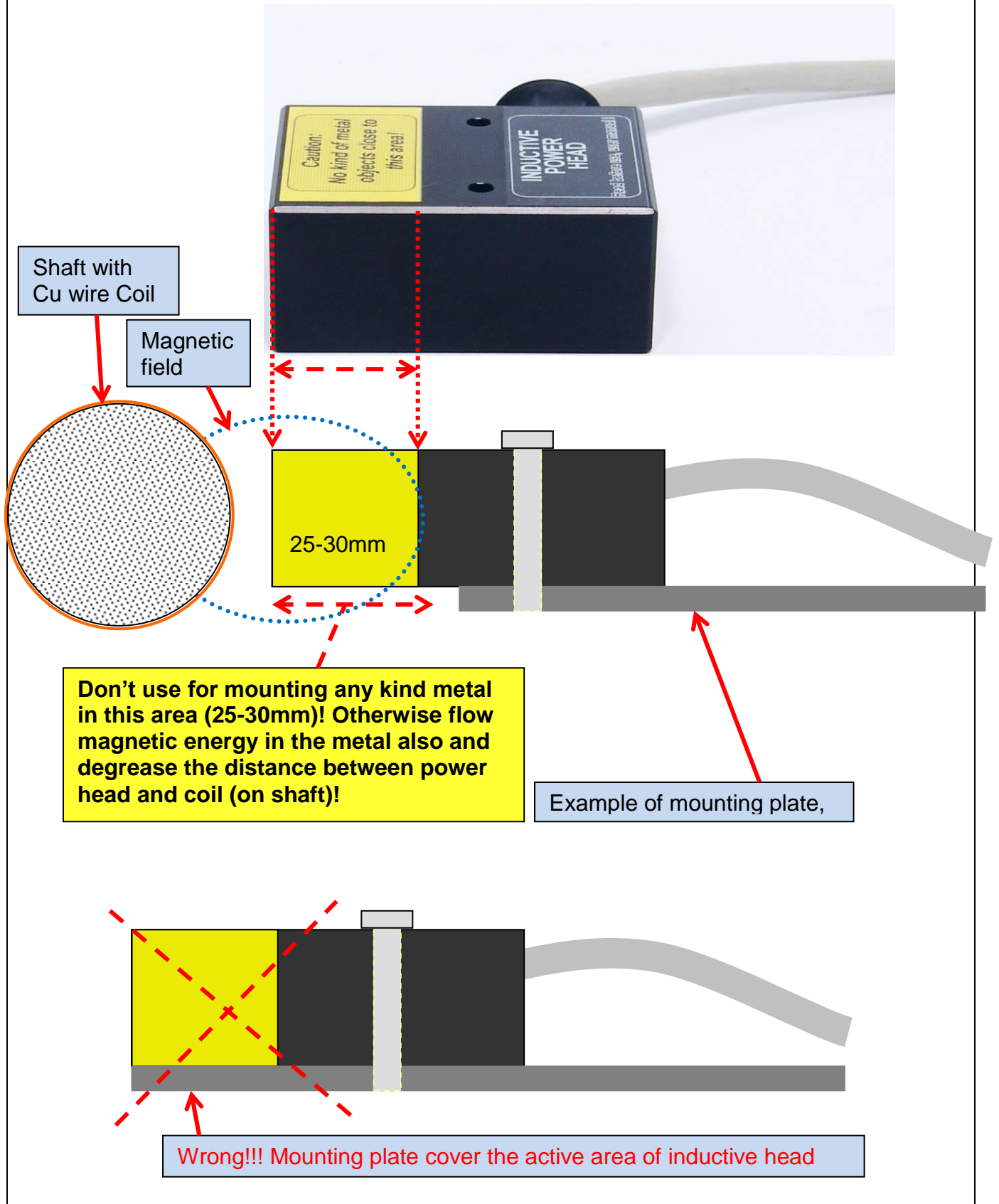



## Dimensions Powerhead / Pickup

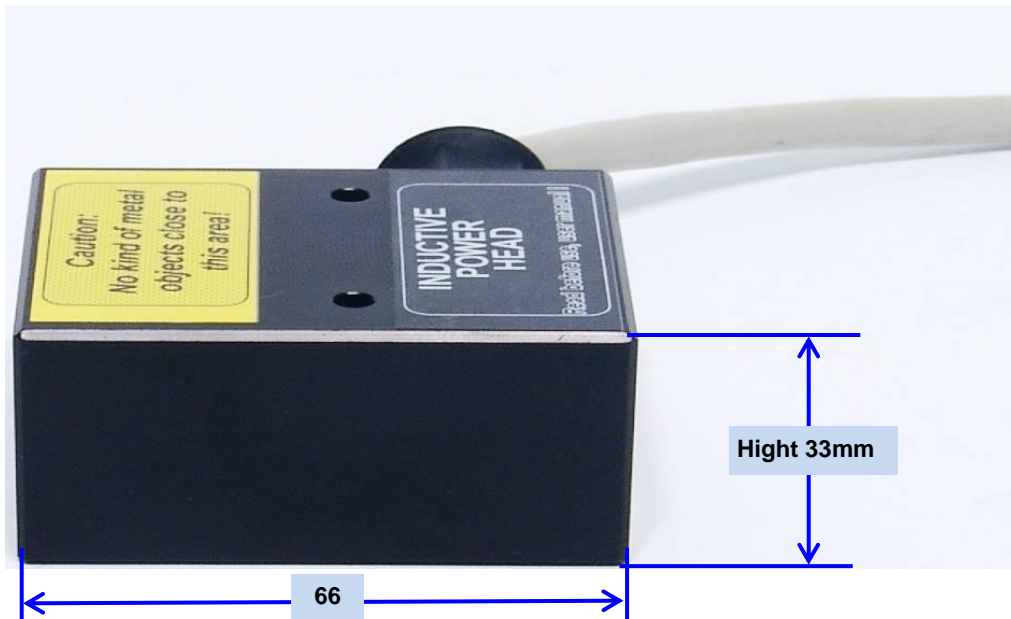
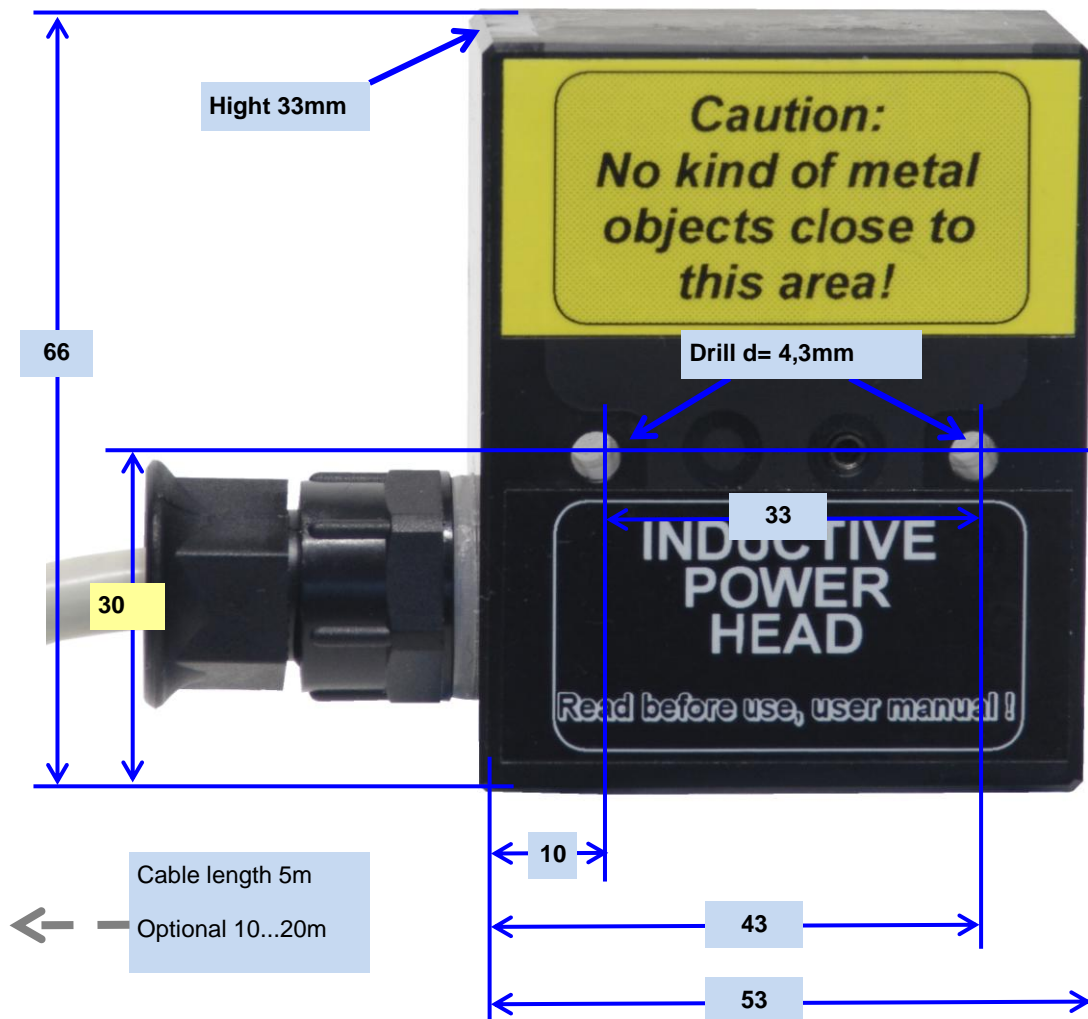

## Attention

- Use only shielded sensor cable
- When used on rotating shafts, all connections must be soldered.
- Mounting of the modules on a shaft must be first fixed with mounting tape (only for prefixing) and then with a **hose clamps!!!**



## Safety Notes for Inductive Powering

- The device should only applied by instructed personnel.
- The power head emits strong magnetic radiation at 30 kHz to a distance of 20 cm. Therefore persons with cardiac **pacemakers** should **not work** with this device!
- Magnetic data storage media should be kept in a distance of at least 3m from the power head to avoid data loss. The same is valid for electromagnetic sensitive parts, devices and systems.
- Do **not place** the power head in the switched-on state **on metallic objects**, because this results in eddy currents, which could overload the device and strongly heat up small objects. In addition, the probe could be destroyed!
- No metallic objects, other than the disc-type coil, should be located in the air gap of the power head. The same applies to metallic parts within a radius of up to 50 mm in all directions.
- Do not use damaged or faulty cables!
- Never touch in the area between shaft and inductive head, the rotating shaft itself or rotor electronic contacts during operation!
- This is a “Class A” system suitable for operation in a laboratory or industrial environment. The system can cause electromagnetic interference when used in residential areas or environments. In this case the operator is responsible for establishing protective procedures.



## Konformitätserklärung

Declaration of Conformity  
Declaration de Conformité

Wir  
We  
Nous

**KMT - Kraus Messtechnik GmbH**

Anschrift  
Address  
Adress

**Gewerbering 9, D-83624 Otterfing, Germany**

erklären in alleiniger Verantwortung, daß das Produkt  
declare under our sole responsibility, that the product  
declarons sous notre seule responsabilité, que le produit

Bezeichnung  
Name  
Nom

**Messdatenübertragungssystem**

Typ,Modell,Artikel-Nr., Größe  
Type,Model, Article No.,Taille  
Type, Modèle, Mo.d'Article,Taille

**TEL1-PCM, TEL1-PCM-BATT**

mit den Anforderungen der Normen und Richtlinien  
fulfills the requirements of the standard and regulations of the Directive  
satisfait aux exigences des normes et directives

**108/2004/EG**

**Elektromagnetische Verträglichkeit EMV / EMC**

DIN EN 61000-6-3 Ausgabe 2002-8 Elektromagnetische  
Verträglichkeit EMV Teil 6-3 Fachgrundnorm Störaussendung

DIN EN 61000-6-1 Ausgabe 2002-8 Elektromagnetische  
Verträglichkeit EMV Teil 6-1 Fachgrundnorm Störfestigkeit

und den angezogenen Prüfberichten übereinstimmt und damit den Bestimmungen entspricht.  
and the taken test reports und therefore corresponds to the regulations of the Directive  
et les rapports d'essais notifiés et, ainsi, correspond aux règlement de la Directive.

**Otterfing, 27.04.2006**

**Martin Kraus**

Ort und Datum der Ausstellung  
Place and Date of Issua  
Lieu et date d'établissement

Name und Unterschrift des Befugten  
Name and Signature of authorized person  
Nom et signature de la personne autorisée

**KMT**  
Kraus Messtechnik GmbH  
Gewerbering 9  
D-83624 Otterfing - Germany  
Tel. 08024-48737 - Fax 08024-5532  
[www.kmt-gmbh.com](http://www.kmt-gmbh.com)

Version 2010-03

15

Technical Data are subject to change without notice!

