

- Low Noise: 10  $\mu\text{g}/\sqrt{\text{Hz}}$  Typical for  $\pm 2\text{g}$  Full Scale Versions
- -55 to +125°C Operating Temperature Range
- Flexible +8 to +32 VDC Power
- Excellent Long-Term Stability
- $\pm 4\text{V}$  Differential Output or 0.5V to 4.5V Single Ended Output
- Responds to frequencies from zero (DC) to 2000+ Hz
- Low Impedance Outputs Support up to 2000 Feet of Cable
- Integrated Cable or Connector, Traditional 1" & Small Footprint Sizes
- Simple Four (4) Wire Connection
- Rugged Anodized Aluminum Case
- Fully Calibrated and Serialized for Traceability

AVAILABLE G-RANGES	
FULL SCALE ACCELERATION	MODEL SUFFIX
$\pm 2\text{ g}$	-002
$\pm 5\text{ g}$	-005
$\pm 10\text{ g}$	-010
$\pm 25\text{ g}$	-025
$\pm 50\text{ g}$	-050
$\pm 100\text{ g}$	-100
$\pm 200\text{ g}$	-200
$\pm 400\text{ g}$	-400

UNIVERSAL ACCELEROMETER MODELS 2210, 2260, AND 2266



SDI's Models 2210, 2260, and 2266 Low Cost Single-Axis MEMS Variable Capacitive Accelerometers are rugged plug-and-play measurement devices for suitable for a wide array of demanding applications. All three models excel in zero-to-medium frequency commercial and industrial applications, particularly where reliable performance, extremely low noise, and long-term stability are absolute requirements.



The 2210 comes in a traditional 1-inch square package and the 2260 and 2266 are the small footprint devices designed for tight spaces. The 2210 and 2260 feature an integrated 3' cable, while the 2266's connector allows for customized cable lengths and easy repositioning. All three models feature a hermetically sealed, low noise SDI surface mount accelerometer, which is individually tested, programmed, calibrated by SDI.

Onboard voltage regulation and an internal voltage reference eliminate the need for precision power supplies. The robust, anodized aluminum case is potted then epoxy sealed and can be mounted easily via two screws, an adhesive, or by attaching a magnet.

ZERO (DC) TO MEDIUM FREQUENCY APPLICATIONS



PERFORMANCE BY G RANGE

INPUT RANGE	SENSITIVITY, DIFFERENTIAL	*FREQUENCY RESPONSE (TYPICAL, 5%)	*FREQUENCY RESPONSE (TYPICAL, 3 DB)	*FREQUENCY RESPONSE (MINIMUM, 3 DB)	OUTPUT NOISE, DIFFERENTIAL (RMS, TYPICAL)	MAX. MECHANICAL SHOCK (0.1 MS)
g	mV/g	Hz	Hz	Hz	$\mu\text{g}/(\text{root Hz})$	g (peak)
$\pm 2$	2000	0 - 250	0 - 525	0 - 300	10	2000
$\pm 5$	800	0 - 400	0 - 800	0 - 420	15	
$\pm 10$	400	0 - 700	0 - 1100	0 - 660	23	
$\pm 25$	160	0 - 1300	0 - 1750	0 - 1050	38	
$\pm 50$	80	0 - 1600	0 - 2100	0 - 1400	60	5000
$\pm 100$	40	0 - 1700	0 - 3000	0 - 1700	121	
$\pm 200$	20	0 - 1900	0 - 3600	0 - 2100	243	
$\pm 400$	10	0 - 2000	0 - 4200	0 - 2400	475	

By Model:  $V_{DD}=V_R=5.0\text{ VDC}$ ,  $T_C=25^\circ\text{C}$

Single ended sensitivity is half of values shown.



Instrumentation Devices Srl  
Via Acquanera 29 - 22100 COMO (Italy)  
ph +39 031 525 391- fax +39 031 507 984  
info@instrumentation.it - www.instrumentation.it

**PERFORMANCE - ALL VERSIONS**

All Models: Unless otherwise specified, Vs=+8 to +32 VDC, TC=25°C, Differential Mode. Span = ±g range = 8000 mV.

PARAMETER	MIN	TYP	MAX	UNITS
Bias Calibration Error (%)		0.25	0.6	± % of span
Bias Calibration Error (mV)		25	60	± mV
Scale Factor Calibration Error <sup>1</sup>		0.5	1.25	± %
Non-Linearity (-90 to +90% of span) <sup>1</sup>		0.15	0.5	± % of span
Bias Temperature Shift (Coefficient)	-200	0	+200	(PPM of span)/°C
Scale Factor Temperature Shift (Coefficient)	-200	0	+200	PPM/°C
Cross Axis Sensitivity		2	3	± %
Power Supply Rejection Ratio	50	>65		dB
Output Impedance		1		Ω
Output Common Mode Voltage		2.5		VDC
Operating Voltage	8		32	VDC
Operating Current (AOP & AON open)		7	10.5	mA DC
Operating Temperature	-55		+125	°C
Mass 2210 / 2260 / 2266 (not including cable)		10 / 6 / 9		grams
Cable Mass (3' integrated cable, 2210, 2260)		14		grams/meter

Note 1: For 2g thru 50g only; 100g and greater versions are tested and specified from -65 to +65g.

NOTICE: Stresses greater than those listed may cause permanent damage to the device. These are maximum stress ratings only. Functional operation of the device at or above these conditions is not implied.

**BIAS & SCALE FACTOR TEMPERATURE SHIFT EXPLAINED**

Every accelerometer has a bias and scale factor temperature coefficient, meaning the output shifts slightly due to temperature changes. Many applications operate within a relatively small temperature band or at room temperature, and therefore rarely encounter interference from the bias or scale factor temperature shifts. These customers are ideal candidates for SDI's standard accelerometer modules 2210, 2260, and 2266.

For applications experiencing larger temperature variations (i.e. exposure to engine temperatures or arctic testing) SDI suggests its Premium High-Performance accelerometer modules, the 2220 and 2276. These contain enhanced, temperature compensated, proprietary SDI Model 1522 accelerometer chips, which are individually tested, calibrated and verified in a climate chamber and come with an initial calibration certificate.

Bias	The accelerometer output with no acceleration present. For SDI's differential output analog accelerometers, it is a signed quantity that is expressed in terms of either g or output volts and is ideally equal to zero g or zero volts.
Scale Factor	The ratio of the change in output to a unit change in the input acceleration expressed in millivolts per g (mV/g). Since the output of most accelerometers is slightly non-linear, the scale factor value is defined as the slope of the least-squares-fit line to the acceleration input vs output curve. SDI measures over the range of -90% to +90% of full scale or from -65g to +65g, whichever is smaller.
Bias Temperature Shift (Coefficient)	The amount of bias shift to expect with a change in temperature expressed as PPM of span per °C. For example, the percent of span bias shift that would occur for a 25g full scale device with a +/-200 PPM of span per °C rating and a 55 °C rise from room temperature would be: $+/-200 / 1,000,000 \times (80C - 25C) \times 100\%$ of span = +/-1.1% of span. The g shift would be +/-1.1% of 50g = 0.55 g. This error in terms of output voltage for a 25 g analog accelerometer would be +/-1.1% of span = +/-1.1% of 8 V = 88 mV.
Scale Factor Temperature Shift (Coefficient)	The amount of scale factor shift to expect with a change in temperature expressed as PPM per °C. For example, the percent shift in scale factor that would occur for a device with a +200 PPM per °C rating and a 60 °C rise from room temperature would be: $+200 / 1,000,000 \times (85C - 25C) \times 100\%$ = +1.2%. For an analog 10g device, the scale factor would rise from its nominal (8 V)/(20 g) = 400 mV/g at +25C to 400 mV/g +1.2% = 404.8 mV/g.

SPECIFICATIONS SUBJECT TO CHANGE WITHOUT NOTICE

## OPERATION

SDI Models 2210, 2260, and 2266 MEMS Variable Capacitive Accelerometers provide optimal performance when they are connected to instrumentation in a differential configuration using both the AOP and AON output signals, but they also support single ended operation for complete flexibility.

These Accelerometers produce differential analog output voltage pairs (AON & AOP) which vary with acceleration. The signal outputs are fully differential about a common mode voltage of approximately 2.5 volts. At zero acceleration, the output differential voltage is nominally 0 volts DC; at  $\pm$ full scale acceleration, the output is  $\pm 4$  volts DC, respectively, as shown in the figure (below). The output scale factor is independent from the supply voltage of +8 to +32 volts.

When a differential connection is not possible, SDI recommends connecting the accelerometer to instrumentation in single ended mode by connecting AOP and GND to the instrumentation and leaving AON disconnected. Keep in mind that the signal to noise ratio is reduced by half for a single-ended vs. a differential connection.

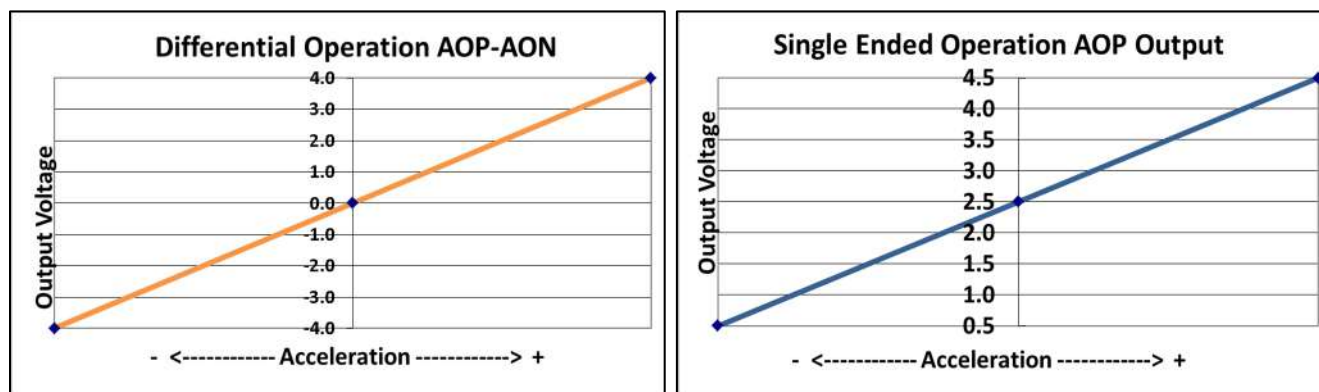

## CABLE SPECIFICATIONS



2210, 2260: The standard 3' integrated cable consists of four 28 AWG (7x36) tin-plated copper wires with Teflon FEP insulation surrounded by a 40 AWG tin plated copper braided shield. The shield jacket is Teflon FEP with a nominal outer diameter of 0.096". The cable's braided shield is electrically connected to the case. The black ground (GND) wire is isolated from the case.



2266: The case's integrated connector shells, pins and sockets are gold plated brass. The 4PIN-CAB cable consists of four 30 AWG (7x38) silver-plated copper wires with PTFE insulation surrounded by a braided shield. The black FEP shield jacket has a nominal outer diameter of 0.100".



The 4PIN-CAB is available in five standard lengths, and custom lengths may be available for special order.

Both cable styles end in a 4-wire pigtail.

NAME	LENGTH - FEET	LENGTH - METERS (APPROXIMATE)
4PIN-CAB-04	4 Feet	1.2 Meters
4PIN-CAB-10	10 Feet	3.0 Meters
4PIN-CAB-20	20 Feet	6.0 Meters
4PIN-CAB-33	33 Feet	10 Meters
4PIN-CAB-50	50 Feet	15.4 Meters

SPECIFICATIONS SUBJECT TO CHANGE WITHOUT NOTICE

## CABLE LENGTH CONSIDERATIONS

Cable lengths of up to 50 feet (15 meters) can be used without the need to test for output instability. For cable lengths exceeding 50 feet, Silicon Designs recommends checking each individual installation for oscillation by tapping the accelerometer and watching the differential output for oscillation in the 20 kHz to 50 kHz region.

If no oscillation is present, extended cable length should behave as expected. From the standpoint of output current drive and slew rate limitations, all SDI Universal Accelerometers are capable of driving over 2000 feet (600 meters) of cable. However, at some length ranging between 50 feet and 2000 feet, each device will likely begin to exhibit oscillation.

## RECOMMENDED CONNECTIONS - DIFFERENTIAL

SDI Models 2210, 2260, and 2266 MEMS Variable Capacitive Accelerometers provide optimal performance when they are connected to instrumentation in a differential configuration using both the AOP and AON output signals.

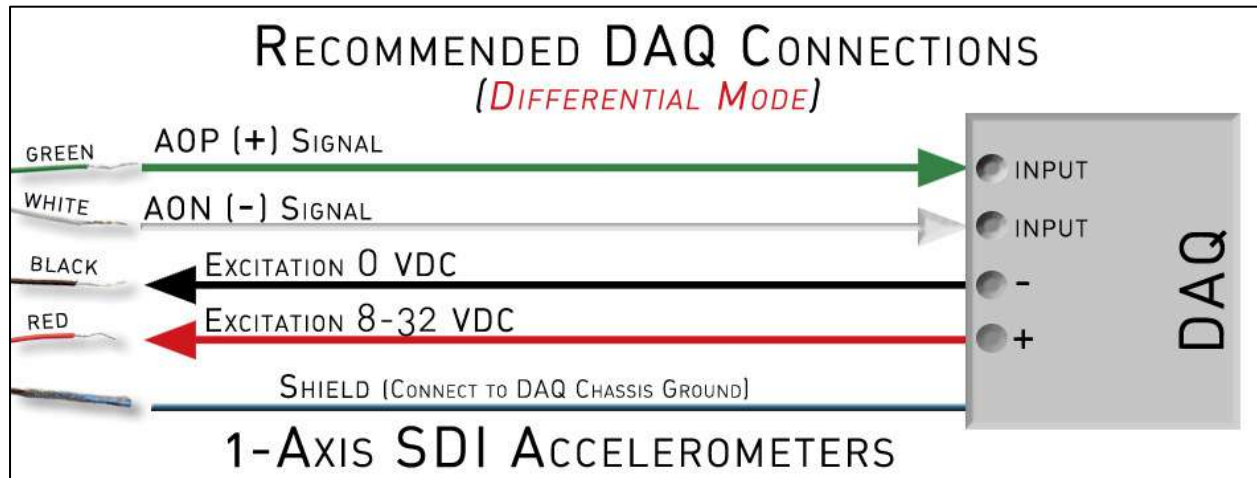
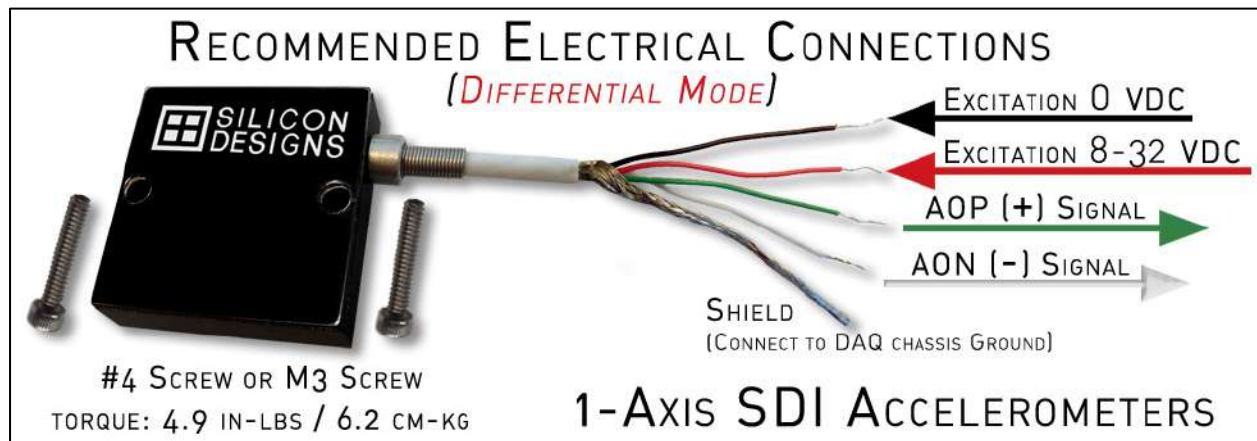

**RECOMMENDED CONNECTIONS – SINGLE ENDED**

Single ended operation is also possible with minor changes to the wiring configuration, as described below.

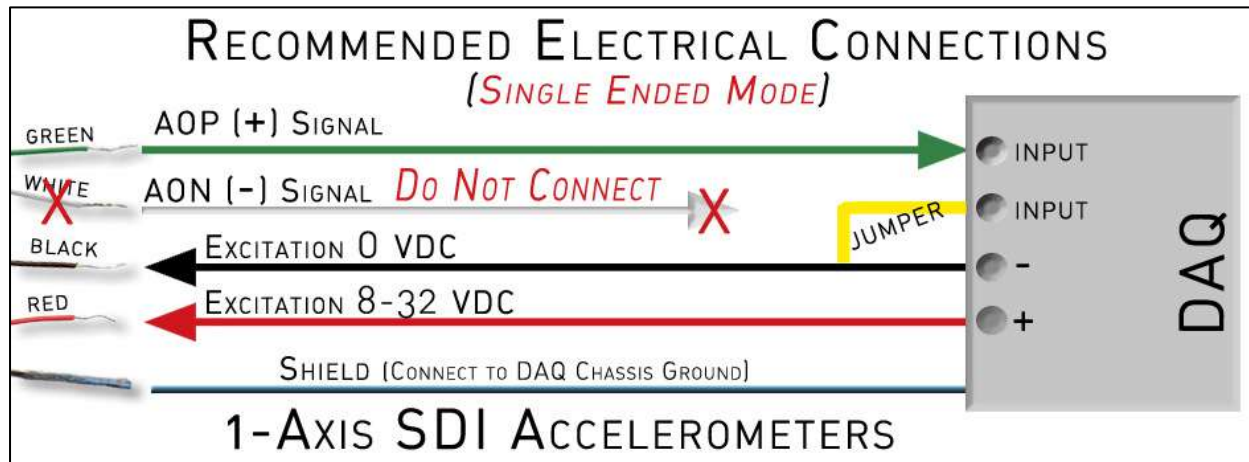
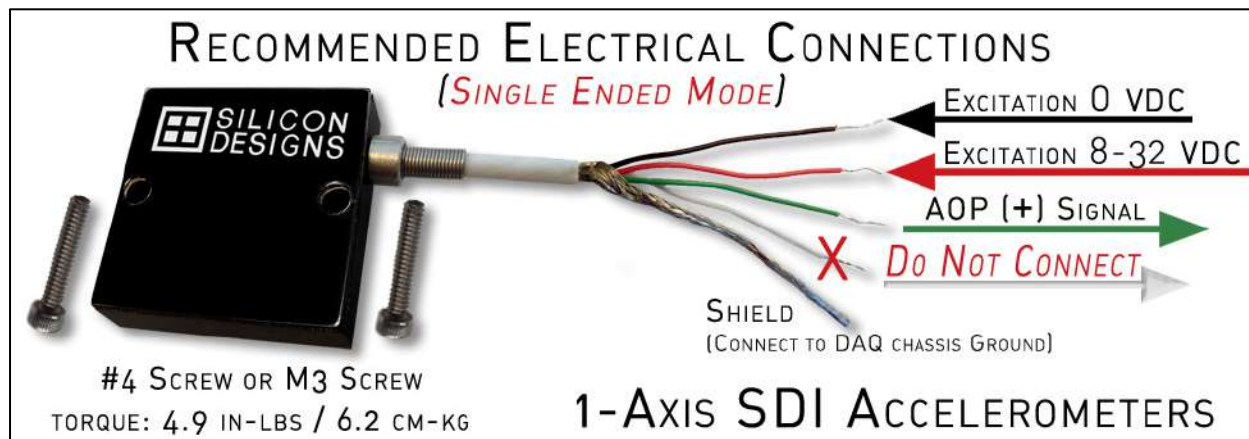
**COMPARABLE 3-AXIS MODELS**

SDI's universal single axis accelerometers are also built in three-axis configurations for multi-dimensional sensing in one package with only a single excitation connection. The SDI Models 2460 and 2466 are the three axis versions of the 2210, 2260 and 2266, using the same hermetically sealed, low noise SDI surface mount accelerometers. The 2460 includes a 3-foot integrated cable and is internally identical to the 2466, which features a connector for easily customized cable lengths and positions.

**OPTIONAL ACCESSORIES**
Model 2230 Triaxial Mounting Block

- Anodized 6061-T6 aluminum 1.25" cube
- Mix and Match g-levels for custom combinations

Model 2232 Magnetic Mount



- 10 lbs / 4.6 KG pull force
- Rated for use up to +/-50G
- Low mass: 23 grams

Model 2235 Stud Mount Adaptor Block

- Stud mount Adaptor for any SDI module
- Anodized 6061-T6 aluminum block
- 6.2 grams, 0.7" x 1" footprint

SPECIFICATIONS SUBJECT TO CHANGE WITHOUT NOTICE

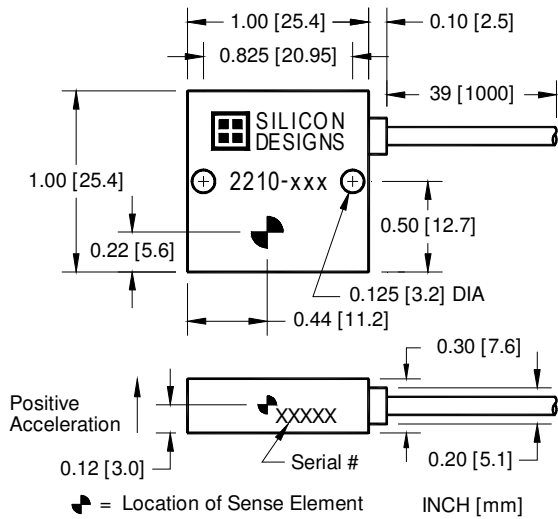
## PACKAGE DIMENSIONS



2210

Module Mass: 10 grams  
Cable Mass: 14 grams/meter

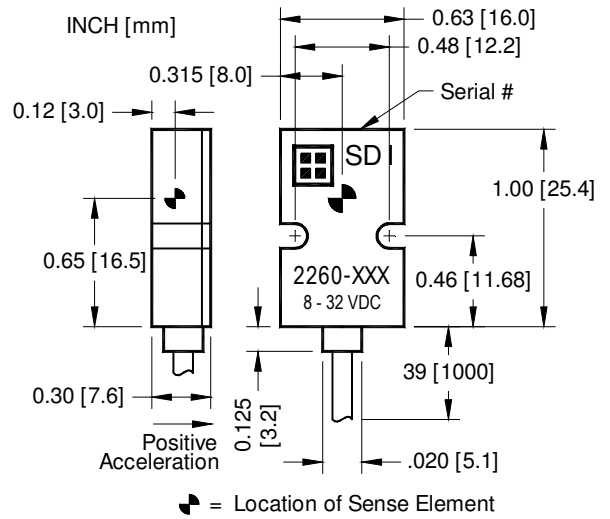

2260

Module Mass: 8 grams  
Cable Mass: 14 grams/meter

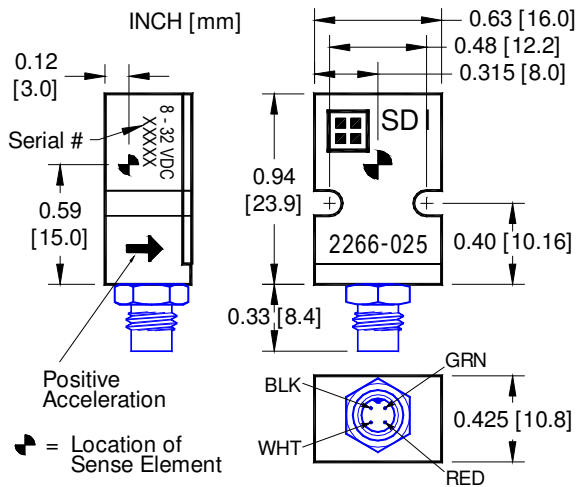

Note: Connector index may not be positioned as drawn

2266

Module Mass: 9 grams

Data sheets dated 1-November-2015 and newer apply to 2210's with serial numbers above 23532, 2260's with serial numbers above 3870, and 2266's with serial numbers above 1000.

Contact SDI for data sheets pertaining to parts made prior to these.

## CALIBRATION REPORT EXAMPLES LINEARITY, PHASE & FREQUENCY RESPONSE BY G-LEVEL

The optional calibration reports provide additional information about the linearity, output, phase, and frequency response as tested for each individual unit. The following are examples of the graphical data supplied on the calibration reports, by G-level.

### EXAMPLE 2G

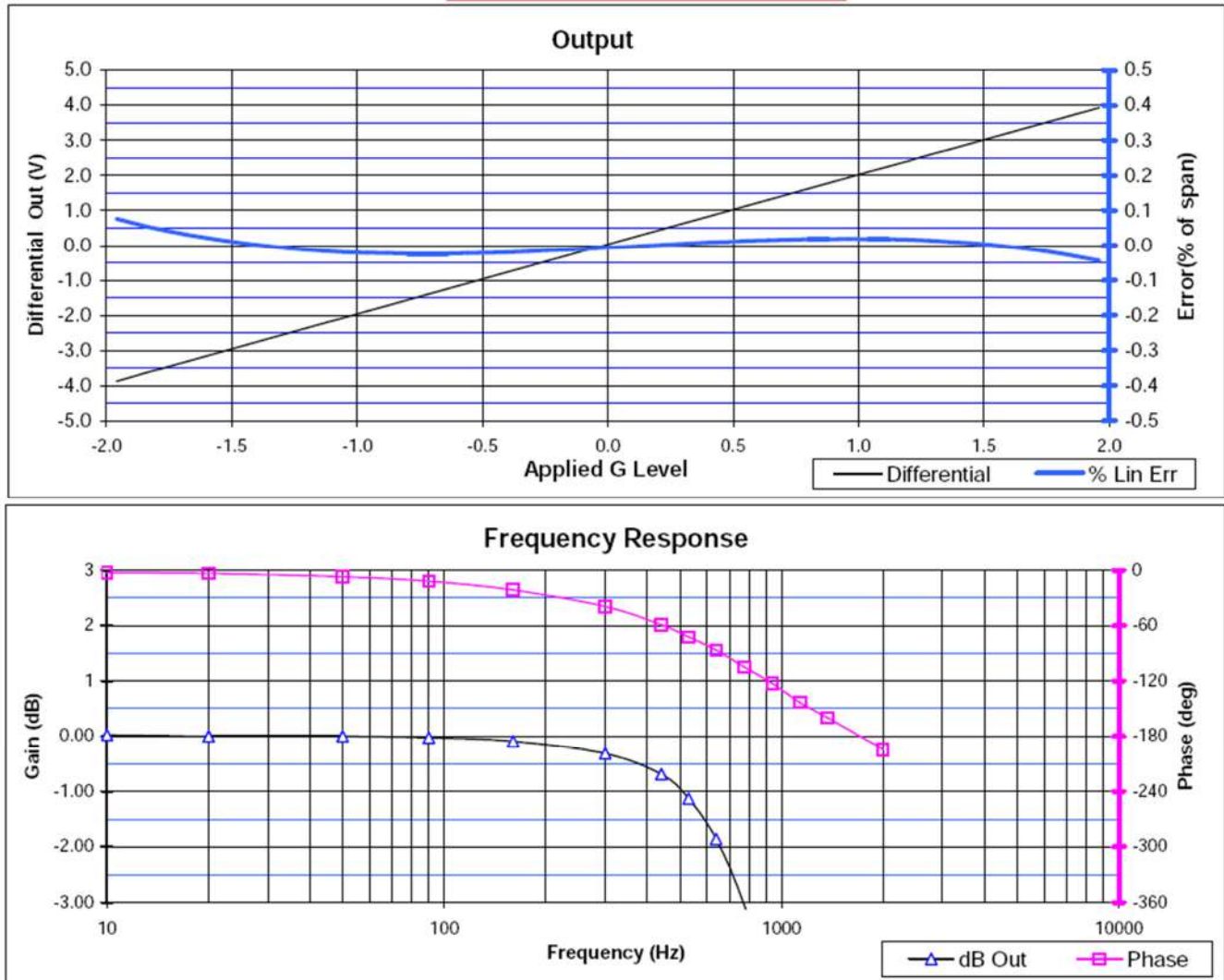

SPECIFICATIONS SUBJECT TO CHANGE WITHOUT NOTICE

Silicon Designs, Inc. • 13905 NE 128<sup>th</sup> Street, Kirkland WA 98034 • Phone: 425-391-8329 • Fax: 425-391-0446

**EXAMPLE 5G**

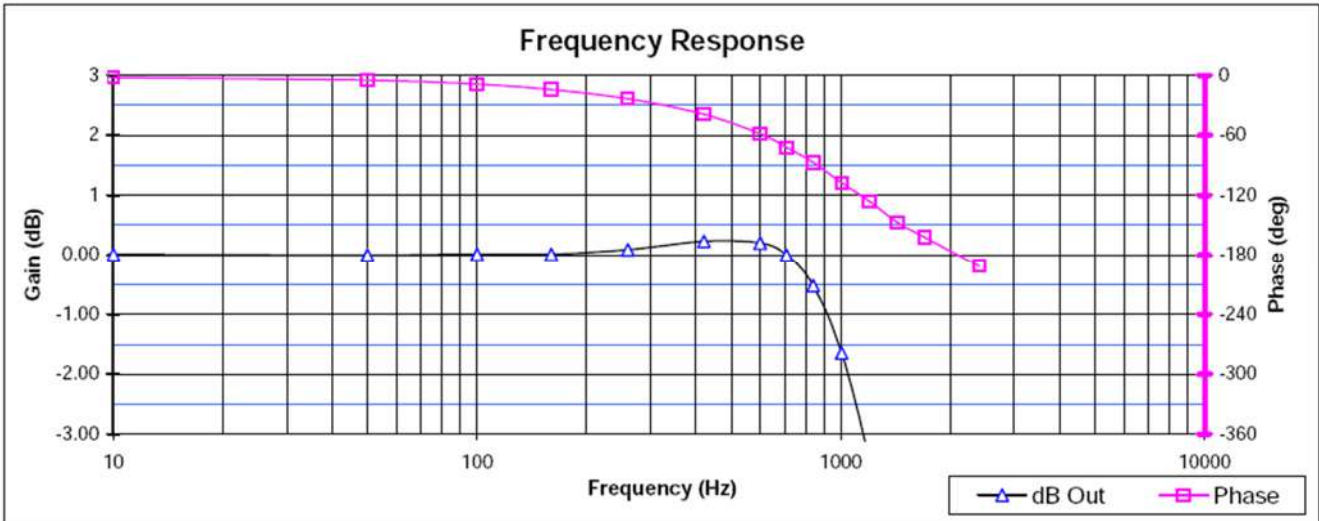
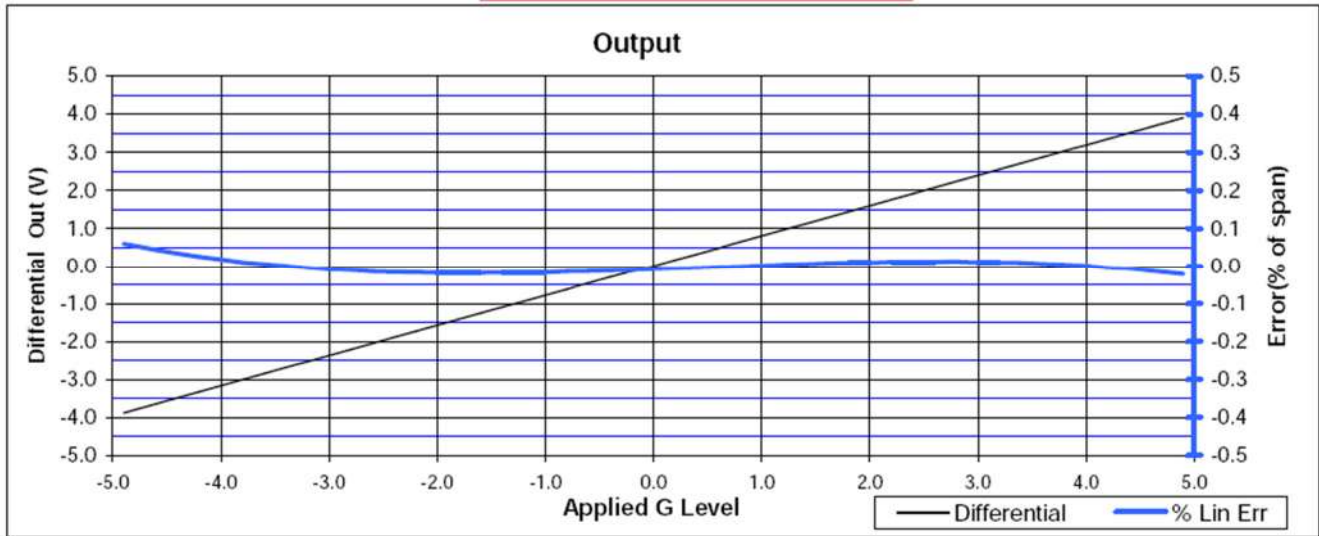

SPECIFICATIONS SUBJECT TO CHANGE WITHOUT NOTICE



**EXAMPLE 10G**

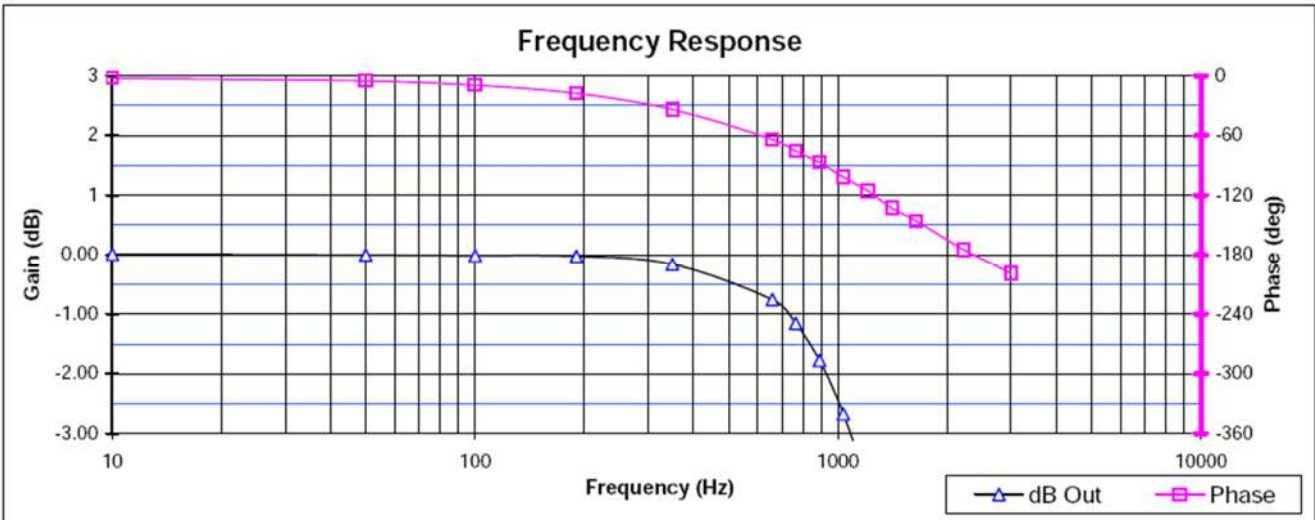
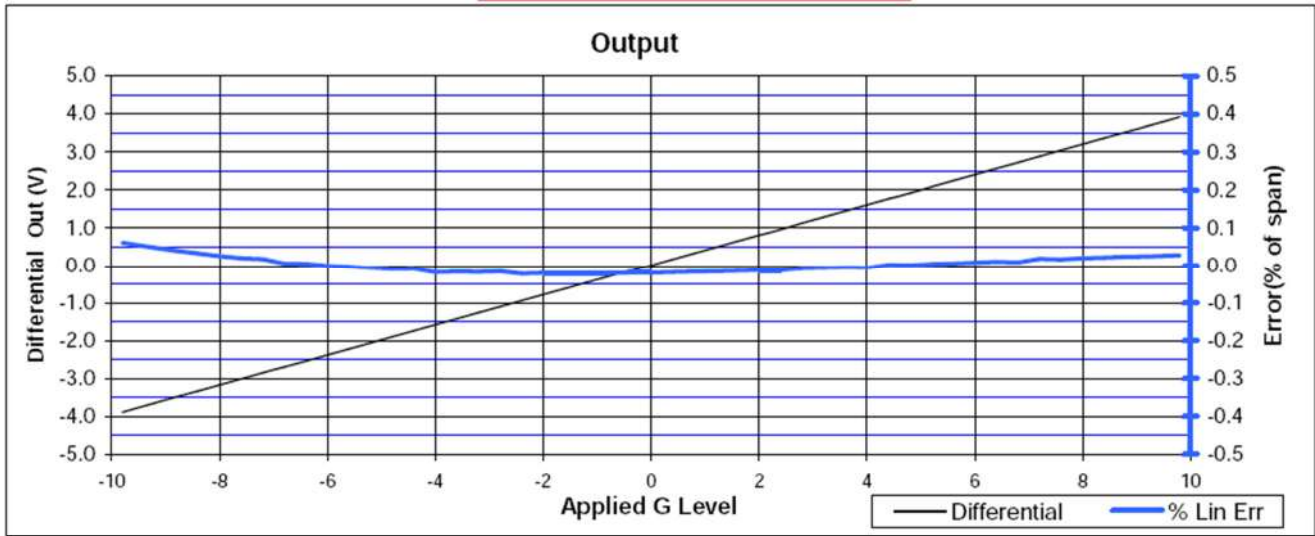

SPECIFICATIONS SUBJECT TO CHANGE WITHOUT NOTICE

**EXAMPLE 25G**

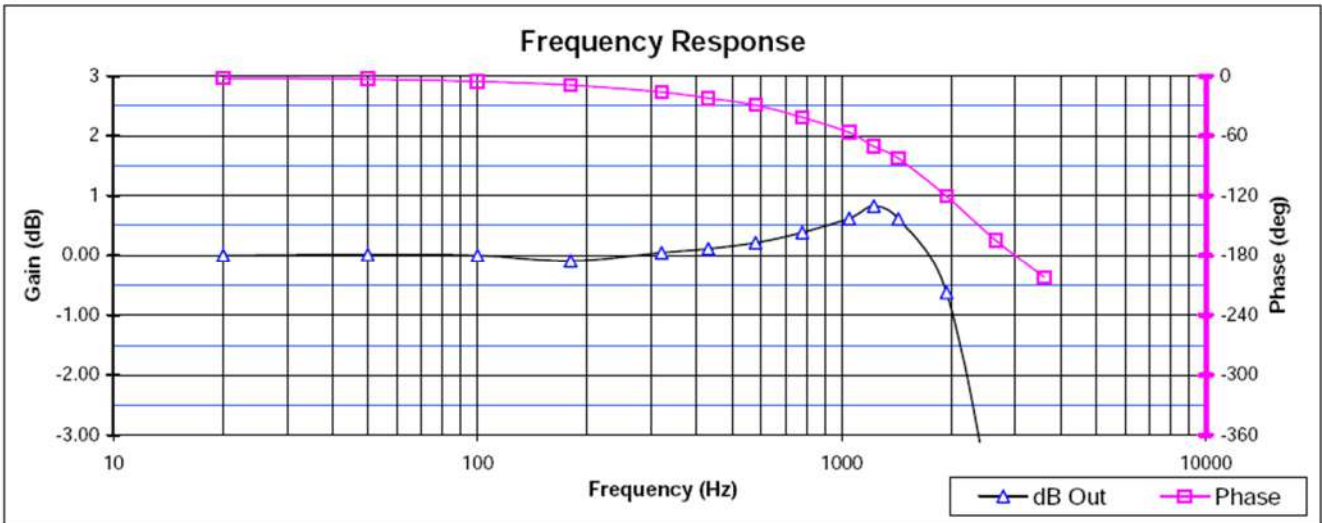
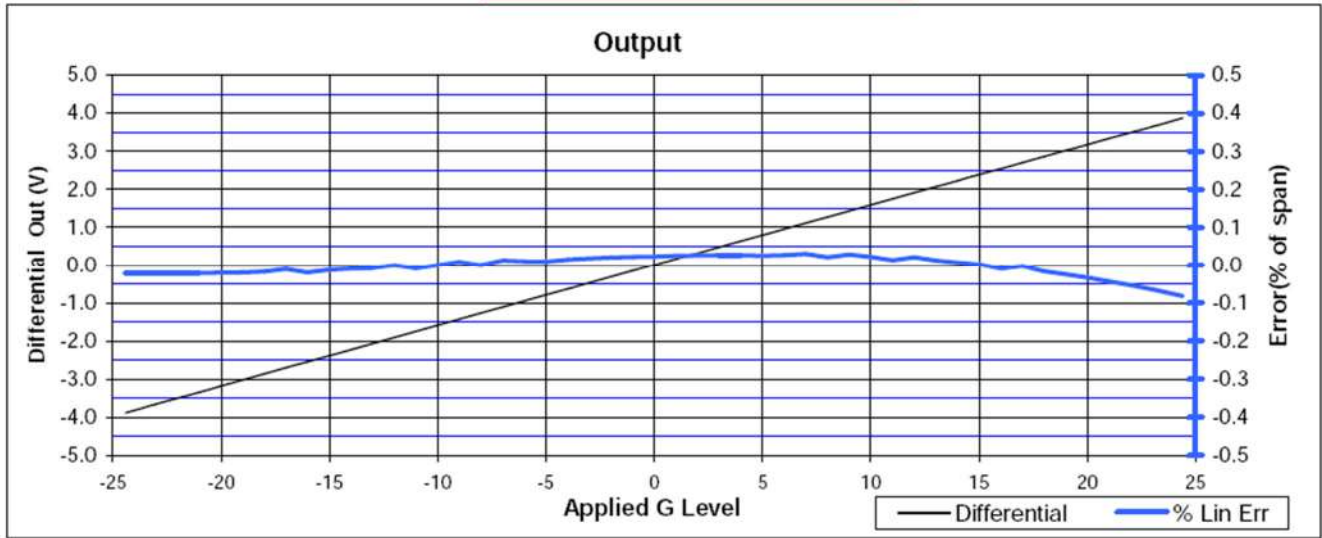

SPECIFICATIONS SUBJECT TO CHANGE WITHOUT NOTICE

EXAMPLE 50G

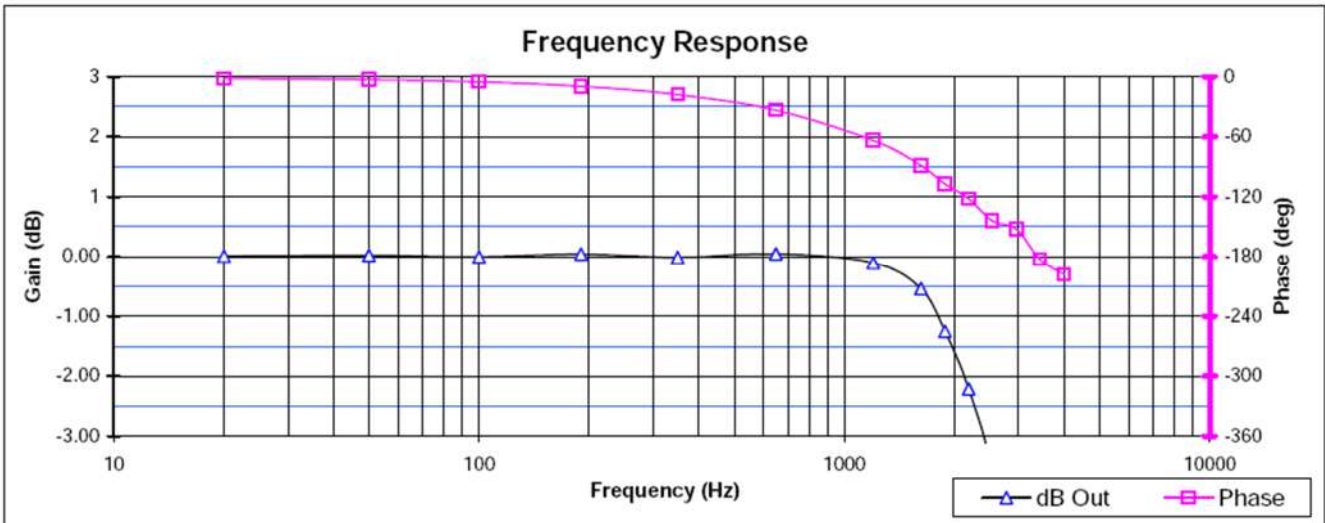
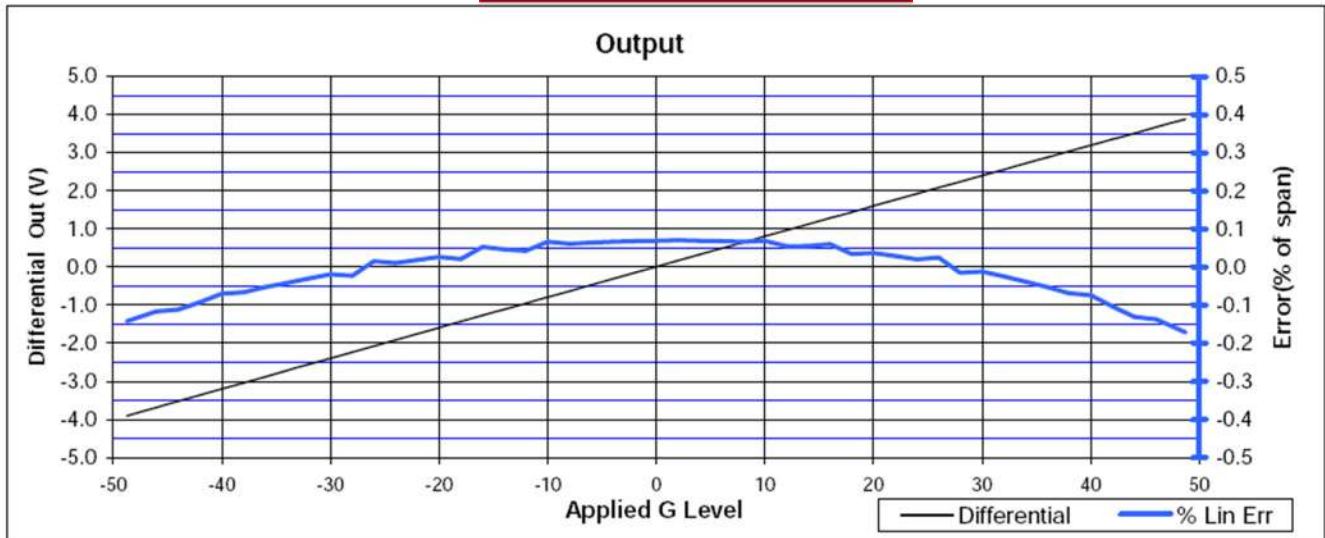

SPECIFICATIONS SUBJECT TO CHANGE WITHOUT NOTICE

**EXAMPLE 100G**

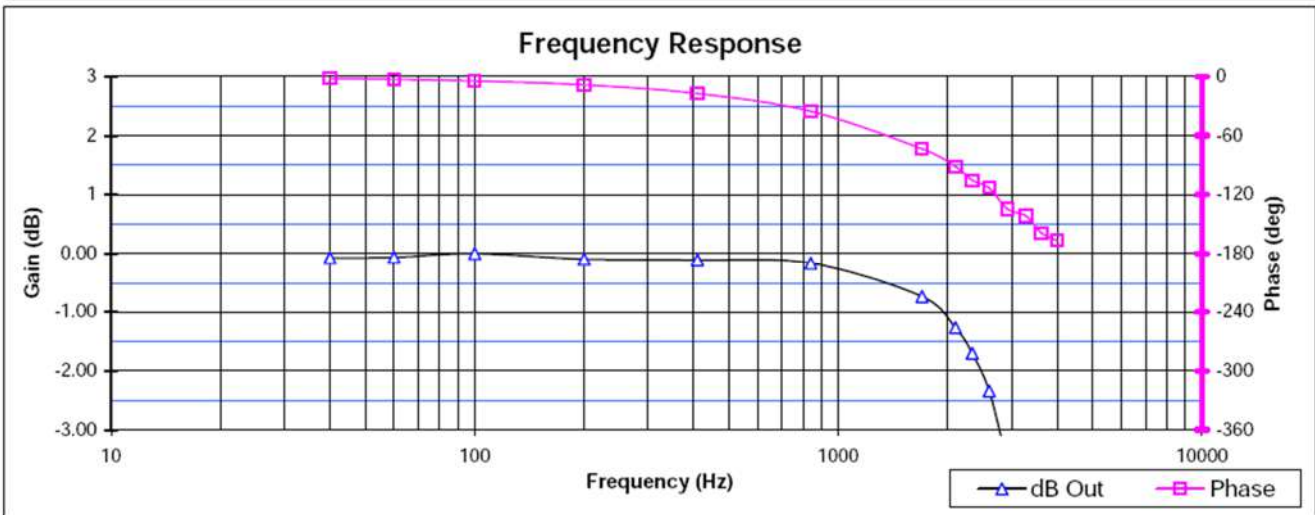
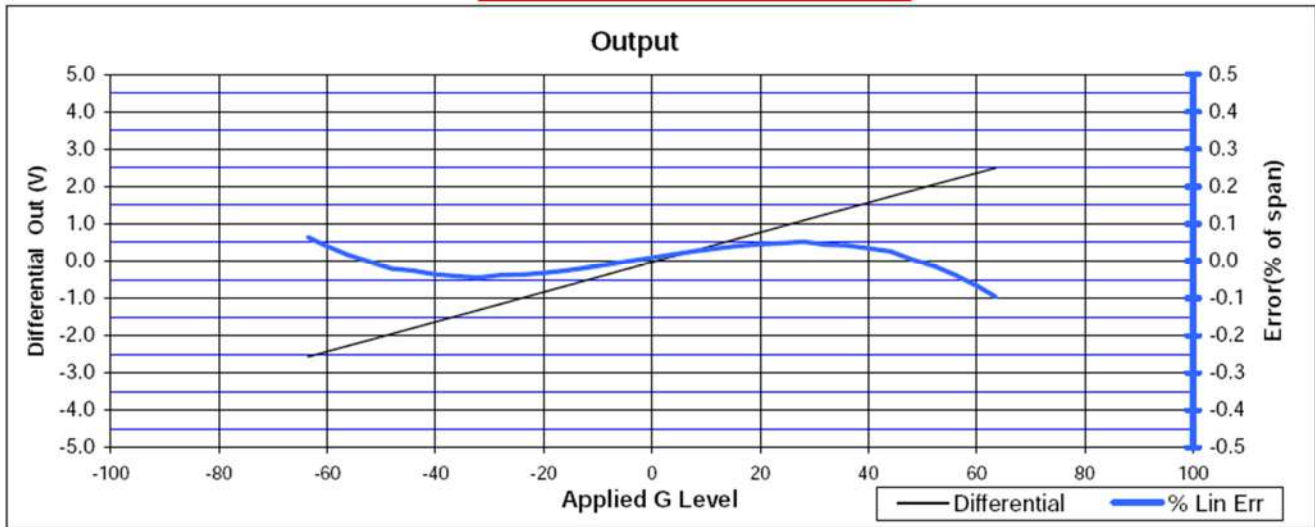

*100g and greater versions are tested and specified from -65 to +65g.*

**EXAMPLE 200G**

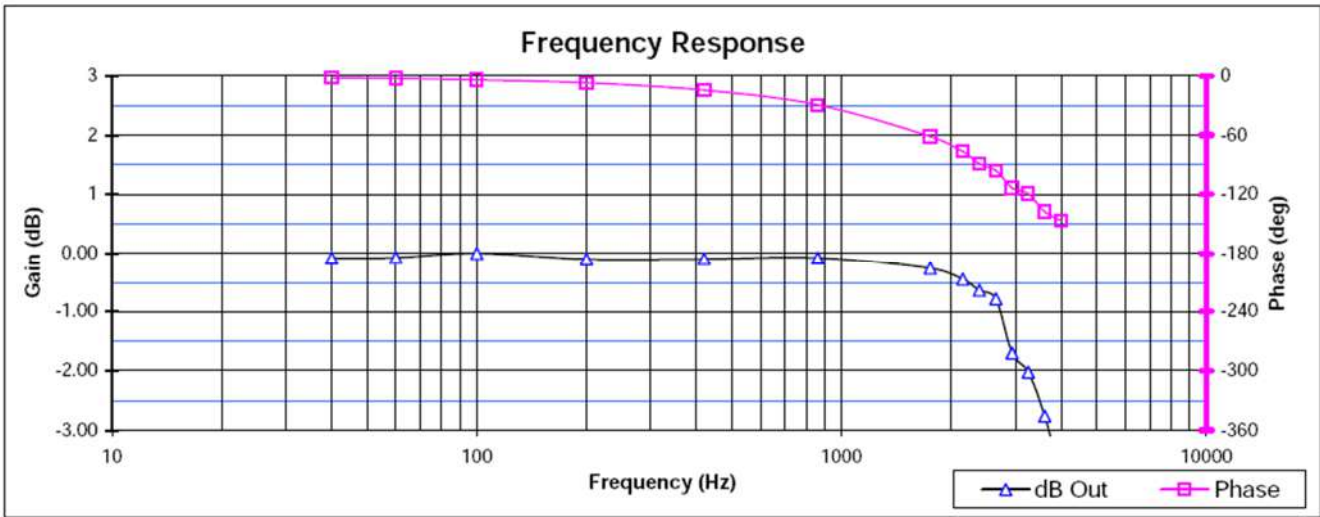
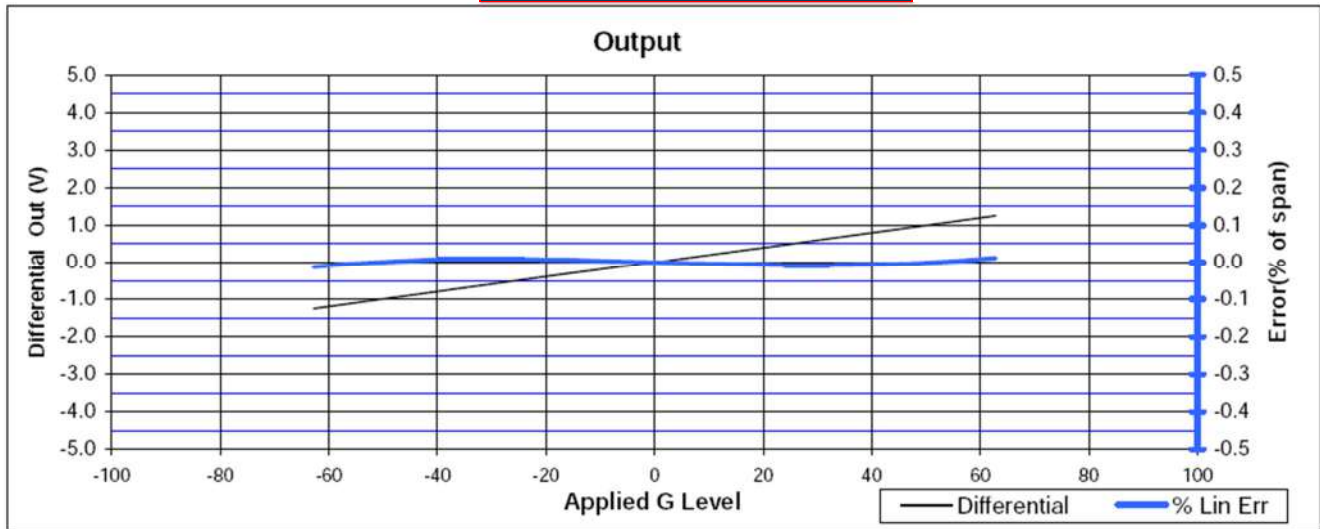

*100g and greater versions are tested and specified from -65 to +65g.*

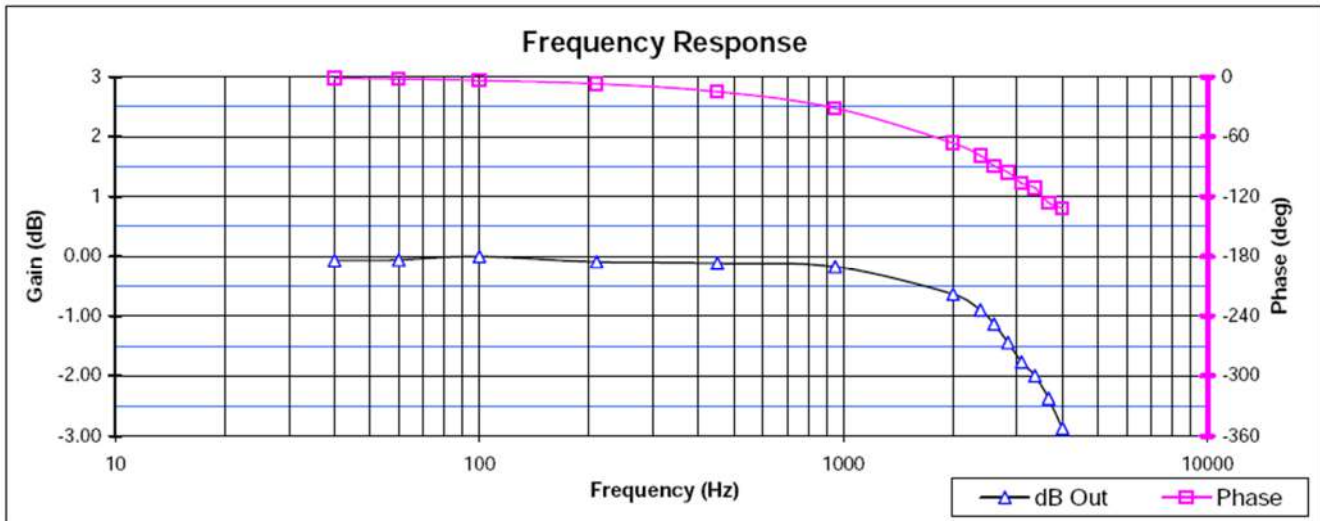
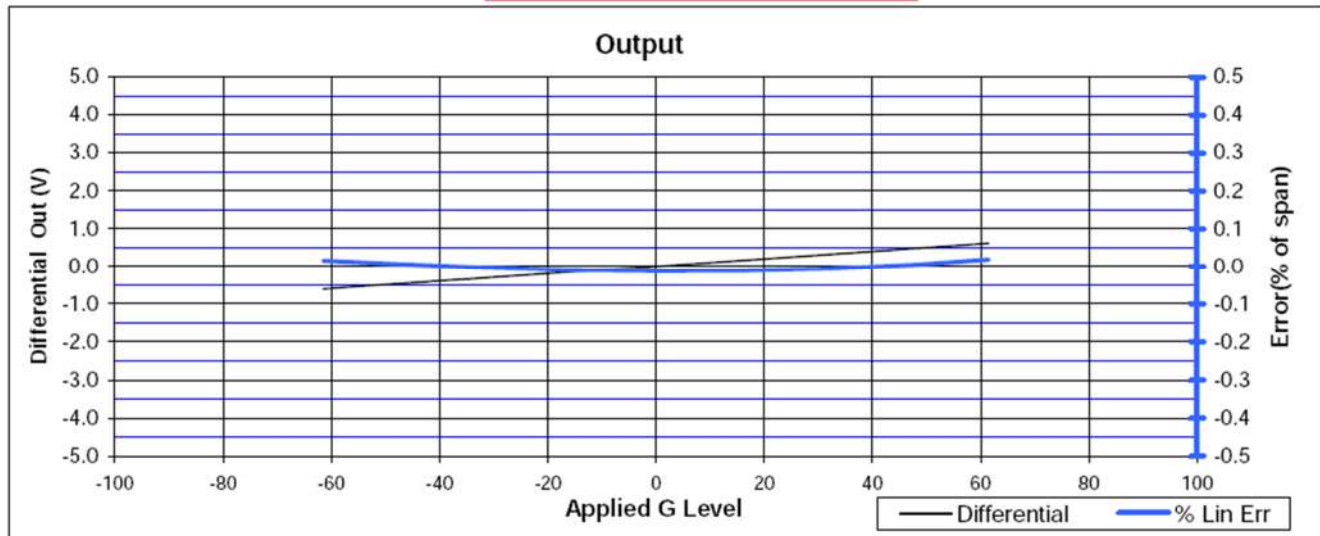
**EXAMPLE 400G**

*100g and greater versions are tested and specified from -65 to +65g.*

SPECIFICATIONS SUBJECT TO CHANGE WITHOUT NOTICE

Silicon Designs, Inc. • 13905 NE 128<sup>th</sup> Street, Kirkland WA 98034 • Phone: 425-391-8329 • Fax: 425-391-0446  
[www.silicondesigns.com](http://www.silicondesigns.com) [page 14] 25-Aug-2020